



# TeamConnect Bar

Model: TC Bar S | TC Bar M

PDF export of the original HTML manual



# Contents

1. Preface.....	5
2. Product information.....	6
Application scenarios.....	8
Mounting options.....	11
Connectivity.....	14
Cable connections.....	14
Supported PoE (Power over Ethernet) standards.....	16
Wireless connections.....	17
Operating modes.....	18
Operation as a stand-alone solution.....	18
Operation as a networked conference system.....	19
Control software.....	21
Network configuration.....	22
Single domain mode.....	22
Dual domain mode.....	25
Split mode.....	28
Danger of network loops.....	30
Dante® features for TC Bar S and M.....	32
Enhanced audio and video coverage.....	34
Status information about energy consumption.....	39
Standby modes.....	40
Activating/deactivating network ports.....	42
Third-party access.....	44
Licenses.....	45
3. Instruction manual.....	47
Quick start.....	47
Product Overview.....	50
Product Overview - TC Bar S.....	50
Product Overview - TC Bar M.....	52
Product overview - remote control.....	54
Meaning of the LEDs.....	56
Mounting.....	63
Safety instructions for mounting.....	63
Mounting the TC Bar on the wall.....	65
Mounting the TC Bar on a table.....	69



Mounting the TC Bar on a tripod.....	72
Mounting the TC Bar on a VESA mount.....	74
Mounting the accessories bracket.....	82
Start-up the product.....	87
Preparing the remote control.....	87
Connecting the TC Bar to the power supply system and starting it.....	90
Connecting the TC Bar to a device (stand-alone solution).....	92
Connecting the TC Bar to an external screen (optional).....	93
Connecting an external PTZ camera.....	94
Usage.....	95
Safety instructions for high volume levels.....	95
Starting a web conference.....	97
Starting a call.....	98
Starting an audio conference using a mobile device.....	99
Muting internal TC Bar microphone.....	100
Setting the volume (remote control).....	102
Setting the camera position.....	103
Camera settings.....	106
Pairing the TC Bar with a Bluetooth® device.....	109
Monitoring & Controlling.....	110
Local Web UI (LUI).....	110
DeviceHub.....	185
Control Cockpit.....	279
Product care.....	356
Cleaning and maintenance.....	356
Replacing remote control batteries.....	357
Storing accessories.....	358
Transport.....	360
4. Knowledge base.....	361
FAQ.....	362
5. Specifications.....	368
Specifications - TC Bar S.....	368
Specifications - TC Bar M.....	373
Specifications - RC TC Bar remote control.....	378
6. Regulatory information.....	379
TC Bar S   TC Bar M.....	380
Remote control RC TC Bar.....	388



Power supply..... 391



# 1. Preface

## **PDF Export of the Original HTML Manual**

This PDF document is an automatic export of an interactive set of HTML manuals. Some content and interactive elements may not be included in the PDF because they cannot be displayed in this format. In addition, automatically generated page breaks may cause related content to be slightly shifted. We can therefore only guarantee the completeness of the information in the HTML manual and recommend using it. You can find it in the Documentation Portal at [www.sennheiser.com/documentation](http://www.sennheiser.com/documentation).



## 2. Product information

All information about the product and available accessories at a glance.

### Features

- **Plug-and-play device:** Quick start via USB cable
- **Integrated beamforming technology:** Freedom of movement and seamless transition between speakers
- **Flexible enhancements:** Using Dante® for adding extension mics and using USB for a 2nd external camera.
- **High video quality:** 4K ultra-HD camera with enhanced AI functions
- **Full-range stereo speakers:** Natural language and outstanding understandability
- **Integrated DSP:** Automatic optimization of room acoustics
- **Several mounting options:** Wall bracket, VESA mount, table setup, or freestanding
- **Automatic framing and tile mode:** Functions so everyone in the room can be seen clearly
- **Control management:** Complete remote access via the Sennheiser Control Cockpit control software
- **Brand-independent integration:** Pending certifications for integrating third-party control systems (Barco, Crestron, Extron, Q-Sys) and platforms (Microsoft Teams, Zoom, Tencent, etc.)
- **Enhanced security functions:** Encrypted communication control that is password-protected by default for safe content transmission

### Delivery includes

- TeamConnect Bar (S or M)
- Mounting bracket
- Power supply unit
  - TC Bar S (S050-1A150300M2)
  - TC Bar M (E096-1A180500B3)
- High-speed HDMI®/TM cable with Ethernet
- USB-C® - USB-C® cable
- Remote control, incl. batteries and bracket (RC TC Bar)
- Magnetic lens cap
- Quick guide
- Safety instructions
- Manufacturer declarations
- Drilling template

### Accessories

#### Bracket

- Art. no. 700116 | TC Bar S mounting kit
- Art. no. 700117 | TC Bar M mounting kit



#### **VESA mount**

- Art. no. 700118 | TC Bar S VESA mounting kit
- Art. no. 700118 | TC Bar M VESA mounting kit

#### **Remote control with bracket**

- Art. no. 700121 | RC TC Bar

#### **Magnetic lens cap**

- Art. no. 700122 | TC Bar S camera cap)
- Art. no. 700123 | TC Bar M camera cap)

#### **Power supply unit**

- Art. no. 700130 | TC Bar S power supply (model: S050-1A150300M2)
- Art. no. 700131 | TC Bar M power supply (model: E096-1A180500B3)

#### **USB-C®/USB-A® cable**

- Art. no. 700312 | USB-C/USB-C® cable 3 M

#### **HDMI® cable**

- Art. no. 700120 | High-speed HDMI®/TM cable with Ethernet

#### **Power cable**

- Art. no. 700119 | TC Bar M power cable (EU)
- Art. no. 700124 | TC Bar S power cable (EU)
- Art. no. 700134 | TC Bar M power cable (US)
- Art. no. 700125 | TC Bar S power cable (US)
- Art. no. 700135 | TC Bar M power cable (UK)
- Art. no. 700126 | TC Bar S power cable (UK)
- Art. no. 700262 | TC Bar M power cable (AUS/NZS)
- Art. no. 700127 | TC Bar S power cable (AUS/ NZS)
- Art. no. 700263 | TC Bar M power cable (CN)
- Art. no. 700128 | TC Bar S power cable (CN)
- Art. no. 700264 | TC Bar M power cable (KOR)
- Art. no. 700129 | TC Bar S power cable (KOR)

#### **System requirements**

- Windows®: 10 or newer
- macOS: 13 or newer
- Android: 11.0 or newer
- Installed DisplayLink® driver on the operating system used



## Application scenarios

The TeamConnect Bar (TC Bar) is an all-in-one conference system for small to medium-sized meeting rooms.



The device can either be operated as an independent conference system at a workstation or as a networked conference system in a meeting room (see [Operating modes](#)). Enhanced microphones and/or a second PTZ camera can be added to the TC Bar using the integrated Dante® interface (see [Enhanced audio and video coverage](#)).

Depending on the size of the room, different models can be used for video and audio transmission:

- TC Bar S: up to 14m<sup>2</sup>
- TC Bar M: up to 27m<sup>2</sup>



### TC Bar S

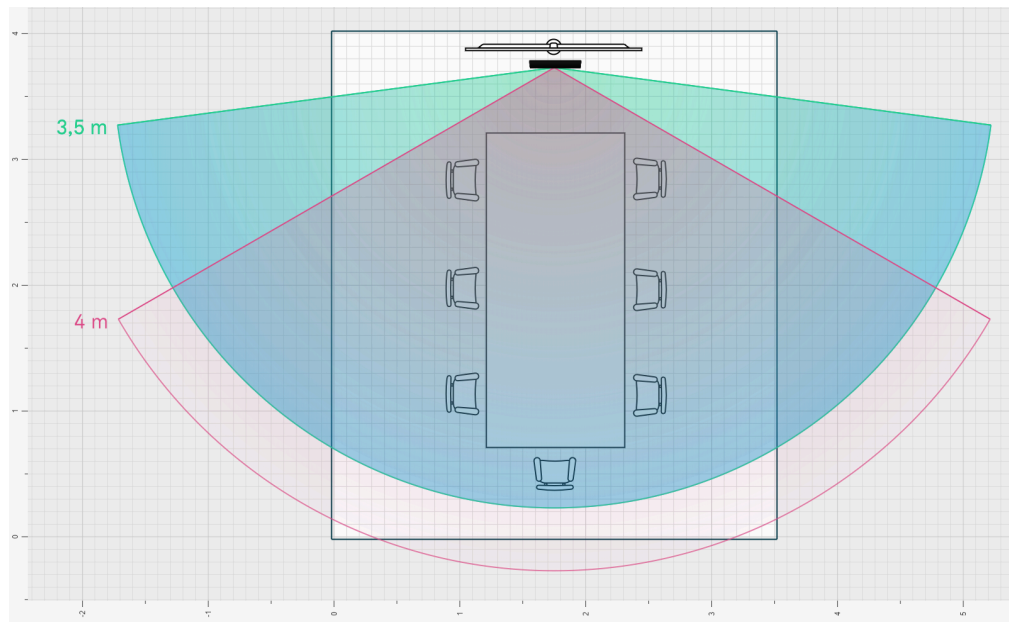

The TC Bar S is designed for small meeting rooms (3 m x 4.5 m (10 ft x 15 ft)) with a maximum of 7 people. The camera records people present in the room at a distance of up to 4 m (13 ft). The beamforming microphones reliably record speakers at a distance of up to 4 m (Ø 13 ft).

### TC Bar M

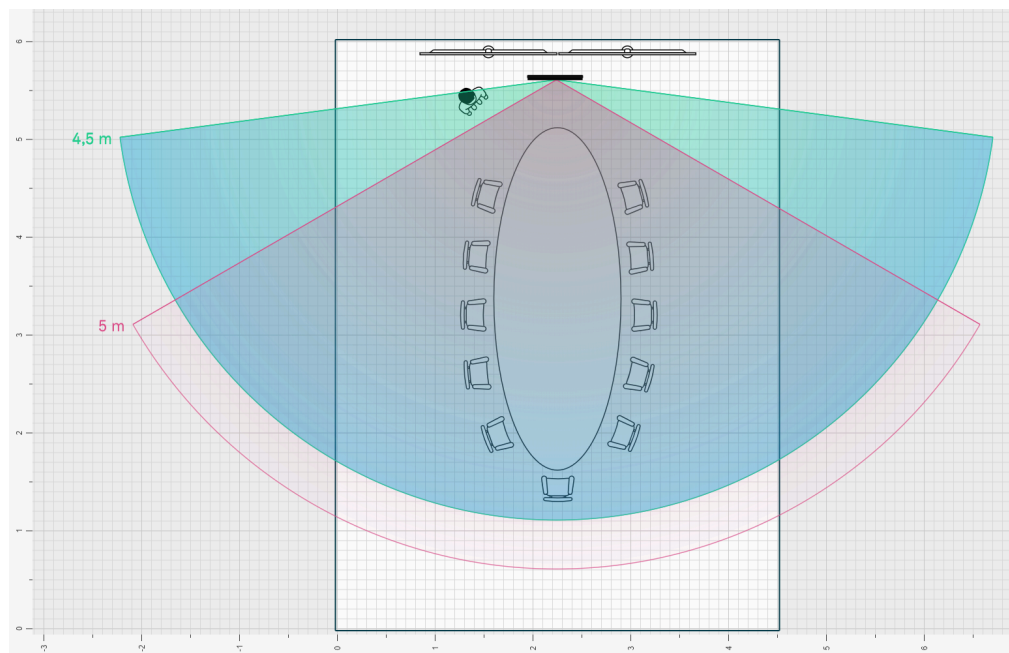

The TC Bar M is designed for medium-sized meeting rooms (4.5 m x 6 m (15 ft x 20 ft)) with a maximum of 10-12 people. The camera records people present in the room at a distance of up to



## | 2 - Product information

to 5 m (16 ft). The beamforming microphones reliably record speakers at a distance of up to 5 m (Ø 16 ft).



## Mounting options

This chapter provides you with an overview of the available options for mounting the TC Bar.

There are various mounting options for attaching and positioning the TC Bar in a room:

- [Mounting on the wall](#) (bracket included in the scope of delivery)
- [Mounting on the table](#) (bracket included in the scope of delivery)
- [Mounting on a VESA mount](#) (optional accessories required, see [Accessories](#))
- [Mounting on a tripod](#) (bracket included in the scope of delivery, but not the tripod)

**i** The chapter [Mounting](#) contains detailed instructions for all mounting options.

### Mounting on the wall

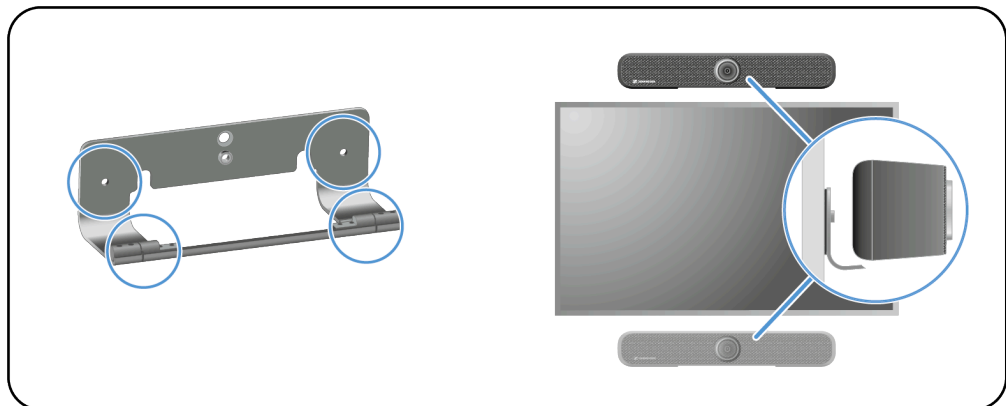

**i** The bracket required for mounting is included in the scope of delivery.

Mounting options:

- Above the screen
- Below the screen



### Mounting on the table

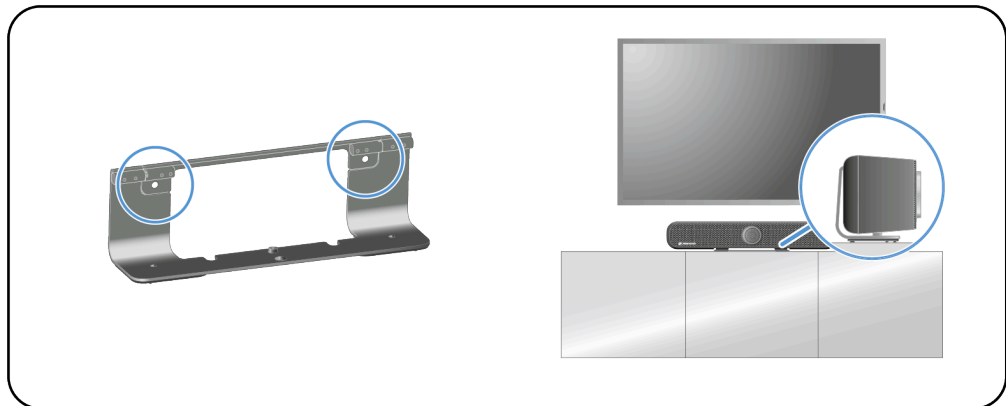

**i** The bracket required for mounting is included in the scope of delivery. The screws and dowels required for mounting are not included in the scope of delivery.

### Mounting on a VESA mount

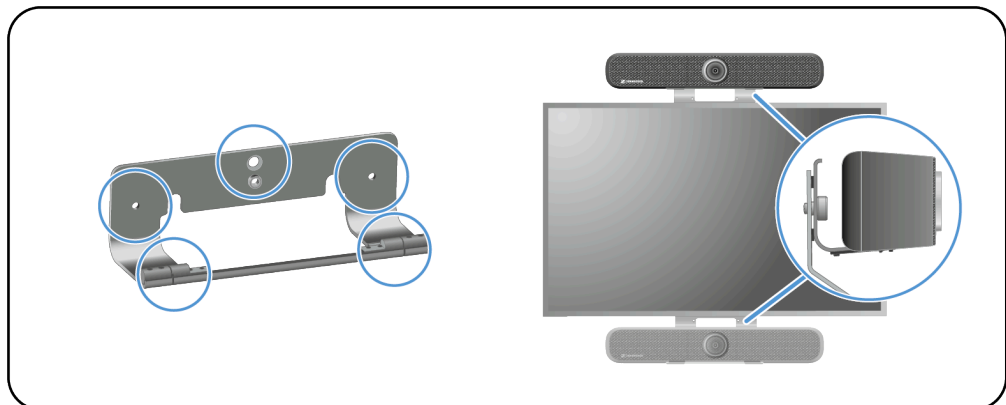

**i** An additional VESA mount is required for this type of mounting ([Accessories](#)).

Mounting options:

- Above the screen
- Below the screen



### Mounting on a tripod

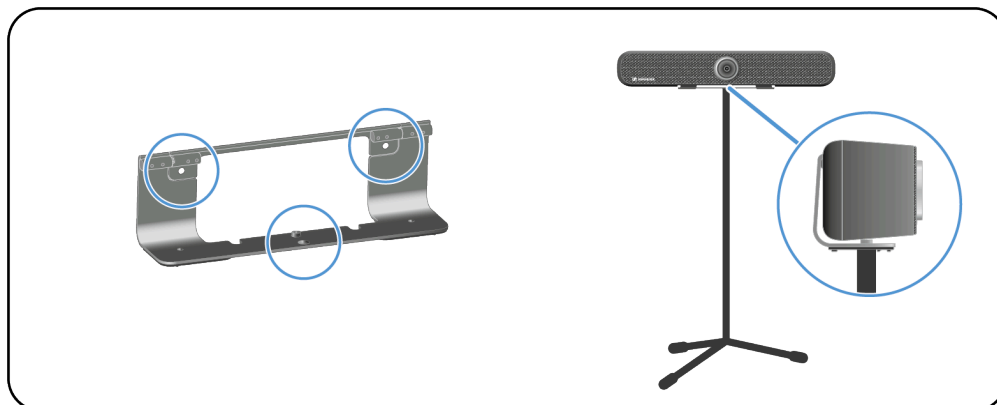

**i** The bracket required for mounting is included in the scope of delivery. The tripod is not included in the delivery.



## Connectivity

The TC Bar features numerous connections and connection interfaces.

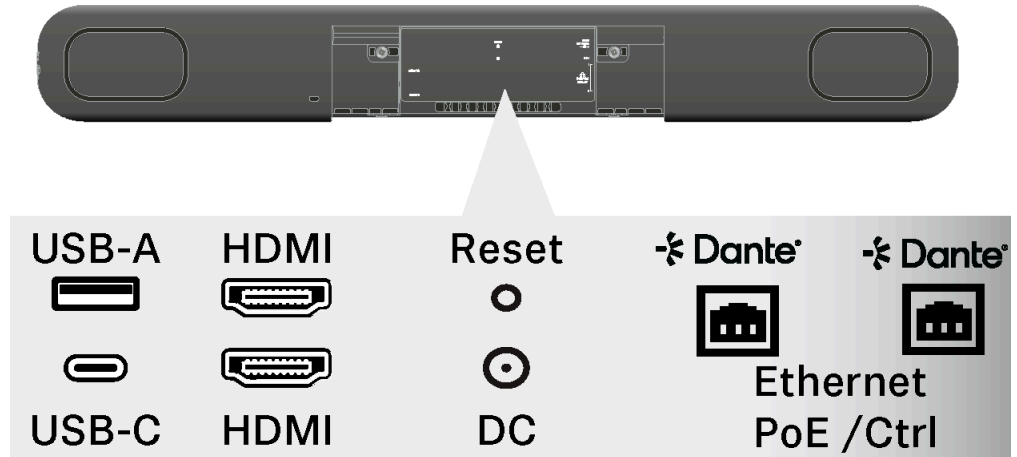

### Overview: cable connections and wireless connections

- USB-C® (main connection for the conference system)
- USB-A (connection for an external PTZ camera)
- RJ45 (Ethernet/control/Dante®)
- HDMI® (connection for screen output)
- DC IN (connection for the power supply)
- Bluetooth®

### Cable connections

Cable connections enable a direct connection between the TC Bar and the far end or networking with an existing network topology.

#### USB-C®

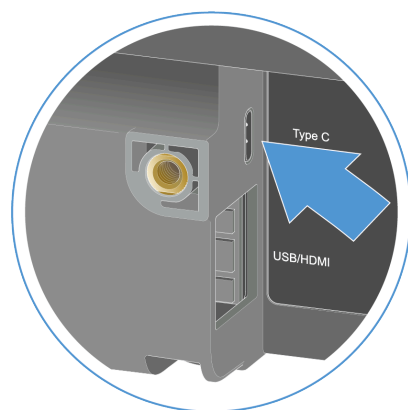

The USB-C® connection is available as the primary interface between the TC Bar and the device used. It can be used to directly connect a conference-capable device (e.g., PC, laptop, etc.) with the TC Bar and operate it (see [Connecting the TC Bar to a device \(stand-alone solution\)](#)).



### USB-A

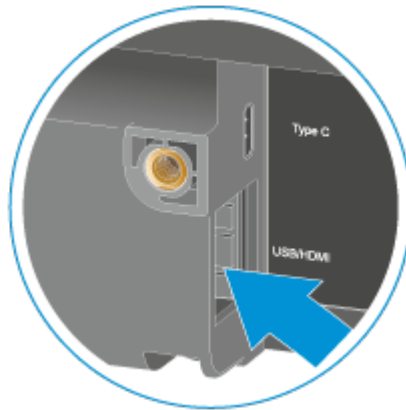

The USB-A connection serves to connect an external PTZ camera (pan tilt zoom) to the TC Bar (see [Connecting an external PTZ camera](#)).

### HDMI®™

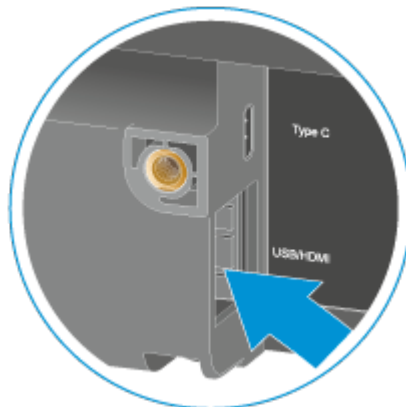

The HDMI® connection serves to transmit outgoing video signals from the TC Bar to an external screen (see [Connecting the TC Bar to an external screen \(optional\)](#)).

### Ethernet RJ45

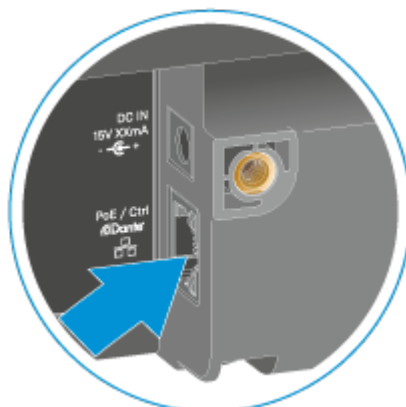

The Ethernet connection (RJ45) serves primarily as a remote connection for claiming, controlling and monitoring the TC Bar via the Sennheiser control application. Furthermore, the RJ45 connection serves as a PoE (Power over Ethernet) connection for alternative power supply for the TC Bar S.

When the Audinate Dante® system is used, the PoE+ (PD) connection of the TC Bar S or the RJ45 connection of the TC Bar M can be used to connect the TC Bar with the Dante controller and operate it via a separate Dante® network (see [Network configuration](#)).



## Supported PoE (Power over Ethernet) standards

Power over Ethernet (PoE) is a network function that can supply network-capable devices with power through an existing data connection.

Power and data transmission takes place solely via a cable (RJ45) and thus enables flexible installation of the devices on site. Depending on the device type, a differentiation must be made between a device providing power (power-sourcing equipment) and a device receiving power (powered device = TC Bar S).

### TC Bar S

- The TC Bar S is a power-consuming PoE+ device (powered device) and can be operated using no more than the network cable.

**i** For continuous power supply, we recommend always connecting the power supply unit included in the delivery (see [Connecting the TC Bar to the power supply system and starting it](#)).



## Wireless connections

The TC Bar has wireless interfaces such as Bluetooth® that allow it to connect with known networks or devices capable of Bluetooth®.

### Bluetooth®

**i** This function is deactivated in the factory settings. It can be activated using the control application (see [Control software.](#))



Via a coupled Bluetooth® connection with the TC Bar, smart devices (such as laptops, smartphones and tablets) can be used to forward microphone signals to the TC Bar and/or output audio signals via the device's speakers.

### Bluetooth® profiles

The HFP and A2DP Bluetooth® profiles make it possible to use bidirectional audio streaming for voice and conference playback, as well as for music applications.

Bluetooth® profiles define certain functions that can be used if a Bluetooth® connection has been established between two devices. Only if both devices support the same profiles can these functions be used together.

#### A2DP (advanced audio distribution profile)

With the A2DP protocol, music can be transferred in stereo quality from a mobile device or another compatible device to the TC Bar via Bluetooth®.

#### HFP (hands-free protocol)

The HFP protocol (hands-free protocol) is required for wireless two-way communication. With it, the voice input during a conference can be transmitted to the TC Bar via the integrated microphones of a mobile device (e.g., a smartphone).



## Operating modes

The TC Bar can be used either as a stand-alone solution in the meeting room or as a networked conference system in an existing network structure.

### Operation as a stand-alone solution

In stand-alone mode, the TC Bar can be connected and operated in just a few steps. No extended configuration or claiming of the TC Bar in the Sennheiser control application is necessary.

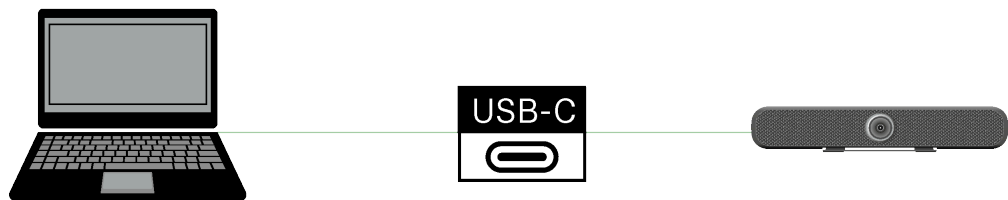

In this operating mode, the TC Bar can be used as a flexible conference system at any location. All that is required is a cable connection via a USB-C® connection with a network-capable PC/laptop or another USB-C®-capable device that fulfills the requirements for operating the TC Bar (see [System requirements](#)).

**i** Please note that only the functions that are accessible via remote control can be used in stand-alone operation (see [Product overview - remote control](#)).

The remote control supports the following functions for the TC Bar:

#### Audio

- Setting the volume
- Muting the internal microphone

#### Camera

- Enabling Auto Framing
- Enabling Person Tiling



## Operation as a networked conference system

When the TC Bar is operated as a networked conference system, you can use the control application to remotely control and monitor the TC Bar.

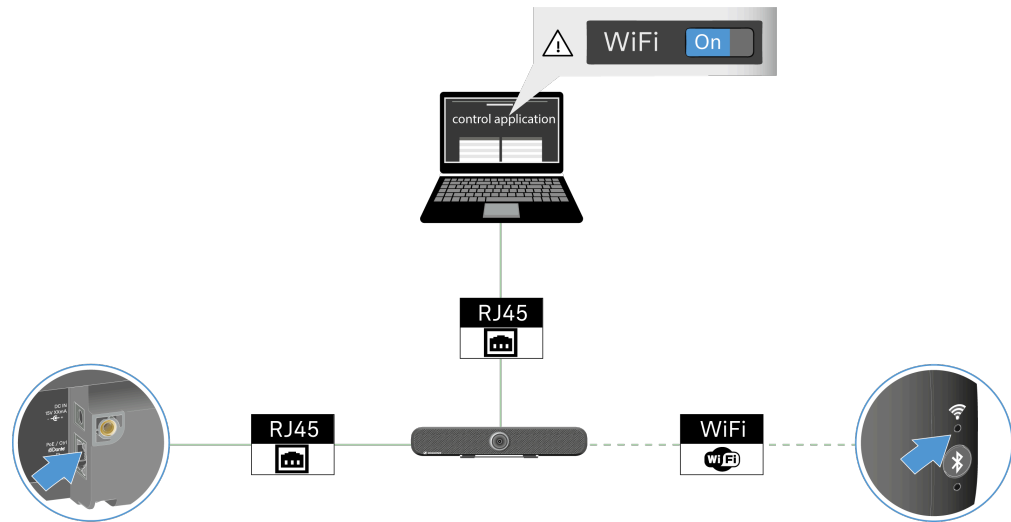

- i** You have the option of controlling the TC Bar with the aid of a media control protocol using a programming interface (REST API). You can find the media control protocol for the TC Bar under [Third-party API for Sennheiser products](#).

You can control and monitor the TC Bar remotely using the control application. The application supports the following functions for the TC Bar:

### Audio

- Selecting the sound profile based on the mounting variant
- Configuring microphone amplification, sensitivity, and noise threshold
- Modifying the automix priority of connected microphones
- Modifying the conference output (far end and near end)
- Modifying the noise suppression
- Modifying the speaker output
- Muting all microphones
- Activating external Dante® speaker output
- Activating/deactivating the function **Location-based Mute**
- Muting the internal microphone
- Resetting audio settings

### Zones

- Activating/deactivating and adjusting a priority zone
- Activating/deactivating and adjusting one to three exclusion zones



## Device

- Performing firmware updates
- Adjusting the device name
- Adjusting the location
- Adjusting the LED brightness
- Selecting the device profile (**MS Teams**, **Zoom**, or **Custom**)
- Activating/deactivating the sound prompts
- Rebooting the device
- Activating/deactivating remote control function
- Activating/deactivating the function **DisplayLink® (HDMI)**
- Changing the energy saving mode
- Restarting the device
- Resetting to factory settings

## Network

- Adjusting the control and Dante® settings
- Activating/deactivating **Bluetooth®**
- Activating/deactivating the Dante® protocol
- Activating/deactivating continuous Dante® stream
- Choosing the network mode

## Camera

- Activating/deactivating and adjusting the white balance
- Activating/deactivating and adjusting the exposure
- Adjusting the brightness
- Adjusting the contrast
- Adjusting the saturation
- Adjusting the sharpness
- Activating/deactivating lowlight compensation
- Activating/deactivating backlight compensation
- Selecting the anti-flicker frequency
- Selecting the auto frame speed
- Selecting the zoom speed
- Selecting the tilting and panning speed
- Activating remote-controlled functions
  - Enabling auto framing
  - Enabling person tiling
- Choosing the default camera mode
- Resetting the camera to factory default settings

## Access

- Third-party access
- Device access



## Control software

The TC Bar can be operated and managed through multiple Sennheiser control applications.

The TC Bar can be configured via various software tools, namely:

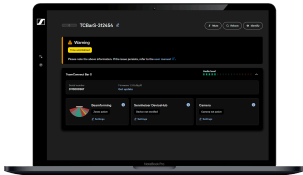
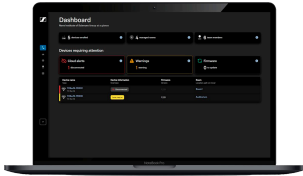
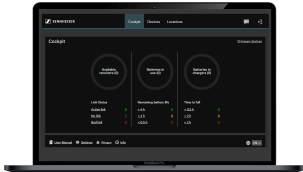
Application	Description
<p><b>Local Web UI (LUI)</b></p> 	<p>LUI is a browser-based interface for easy and quick device configuration in the local network and is accessible over the device IP address or host name. LUI is available as of firmware version 2.0.0.</p> <ul style="list-style-type: none"><li>• Online manual: <a href="#">Local Web UI</a></li></ul>
<p><b>DeviceHub</b></p> 	<p>Cloud-based platform for managing and monitoring Sennheiser AV devices across locations. DeviceHub compatibility is available as of firmware version 2.0.0.</p> <ul style="list-style-type: none"><li>• Online manual: <a href="#">DeviceHub</a></li><li>• Product info: <a href="https://sennheiser.com/devicehub">sennheiser.com/devicehub</a></li><li>• Software: <a href="https://devicehub.sennheiser.com">https://devicehub.sennheiser.com</a></li></ul>
<p><b>Control Cockpit</b></p> 	<p>On-premise centralized management software that allows you to configure your TC Bar.</p> <ul style="list-style-type: none"><li>• Online manual: <a href="#">Control Cockpit</a></li><li>• Product info: <a href="https://sennheiser.com/control-cockpit">sennheiser.com/control-cockpit</a></li></ul>

Details on the control solutions can be found in chapter [Monitoring & Controlling](#)



## Network configuration

You can configure different network modes for the TC Bar using the control application and thus adapt the device to the existing network structure.

**The TC Bars are in the following network modes in the factory settings:**

- TC Bar S: Single domain mode
- TC Bar M: Split mode

### Single domain mode

The Sennheiser control application is in the same network as the Dante Controller.

This mode is generally used if you want to use both the controller (from Sennheiser or a third-party provider) and Dante® on the same physical port with only one available IP in the same network.

To set up both configurations, you need a Sennheiser control software for the control network and the Dante® software (Dante Domain Manager or Dante Director) for other routed Sennheiser devices.

**Use this mode if you want to:**

- Configure both the Dante® and the control network using a switch
- Use only one IP for both networks
- Control both networks using a single network connection of the TC Bar.



### Simplified network diagram for the TC Bar S:

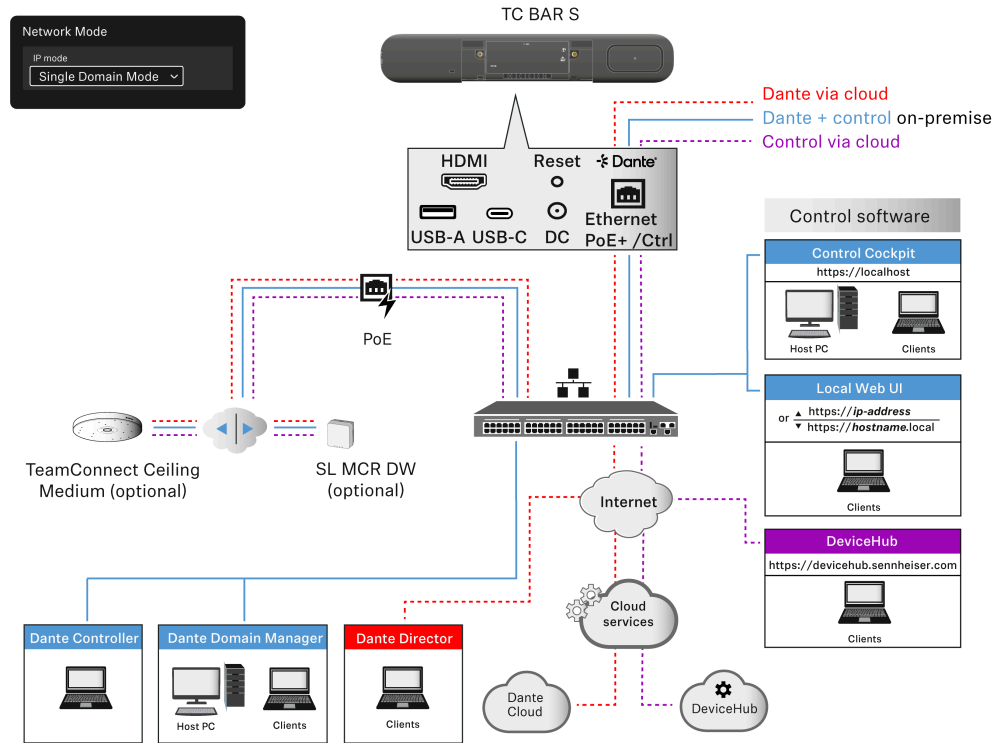

The TC Bar S has only one network connection and can provide only a combined data flow for Dante® and the control using a switch.

### Simplified network diagram for the TC Bar M:

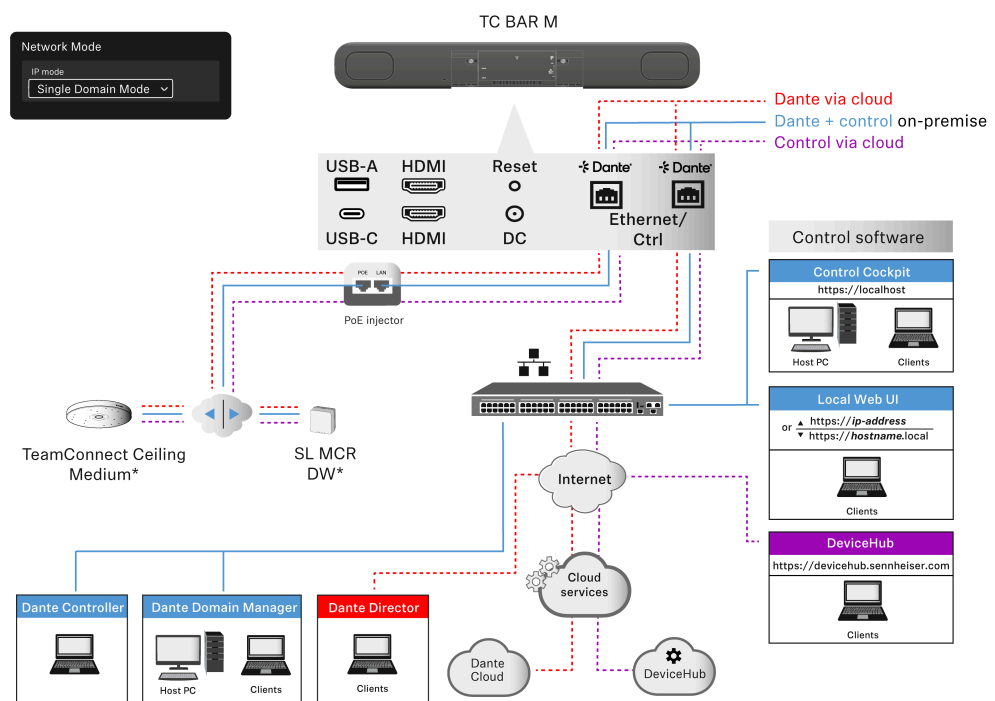



The TC Bar M has two network ports that share one IP in this mode.

One port can be used to control the bar via the network using the Dante Controller and using the control application directly via a switch. The other port serves to connect routed Sennheiser devices using the Dante Controller (e.g., TCC M).

Any connected enhancements can be managed using the Dante Controller and the control application because the TC Bar M forwards the signals using the integrated switch.

- i** To keep the second Ethernet connection of the TC Bar free, the enhanced Sennheiser products can also be connected using the network switch. Always make sure to connect the TC Bar M to two different networks that do not run through a common switch (see [Danger of network loops](#)). Otherwise, there is a danger of a network loop occurring.



## Dual domain mode

In this mode, the Sennheiser control application and Dante Controller are in different networks and have different outgoing IP addresses. Outgoing data packages are tagged as VLAN (virtual local area network).

This mode is generally used if you receive a combined data flow from two separate networks through a single network line and want to split this combined data flow into two different IP and MAC addresses again. Doing so lets you operate the Dante® network and the control network independently of one another using the same switch.

Outgoing Dante® data packages are tagged as VLAN (virtual local area network) according to the standard 802.1q. The incoming data packages must also be tagged by the externally connected network so they can be properly assigned for internal use. Depending on the device, the data packages must be translated from the outgoing 802.1q standard to 802.3 using a managed switch.

**i** Please note that VLAN tagging must be active in the Sennheiser control application (see [Activating tagged VLAN \(Dante® network\)](#)).

### **Use this mode if you want to:**

- Configure both the Dante® and the control network using a switch
- Use two different IPs to address the control network and the Dante® network separately
- Control both networks using a single network connection of the TC Bar.

### **Simplified network diagram for the TC Bar S:**

- In this mode, the TC Bar S receives two different IP addresses.
- One IP is used to address the TC Bar through the control application.
- The other IP is used to address the TC Bar through the Dante Controller.

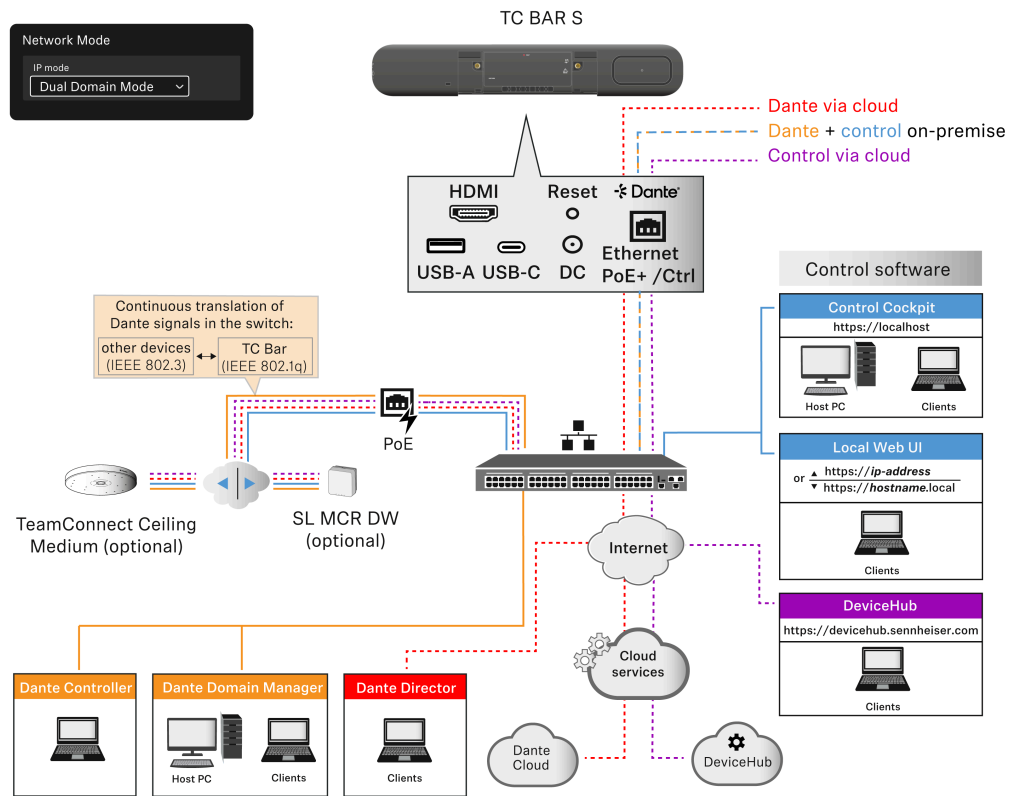

### Simplified network diagram for the TC Bar M:

- In this mode, the TC Bar M receives two different IP addresses.
- Both Ethernet ports can be used to address the TC Bar through both the control application and the Dante Controller. In this case, one IP is available for Dante® and one IP for the application.
- Any connected enhancements can be managed using the Dante Controller and the control application because the TC Bar M forwards the signals using the integrated switch.
- When a Dante Controller is used, the data packages are also tagged as VLAN (see [Activating tagged VLAN \(Dante® network\)](#)).

**i** Always make sure to connect the TC Bar M to two different networks that do not run through a common switch (see [Danger of network loops](#)). Otherwise, there is a danger of a network loop occurring.

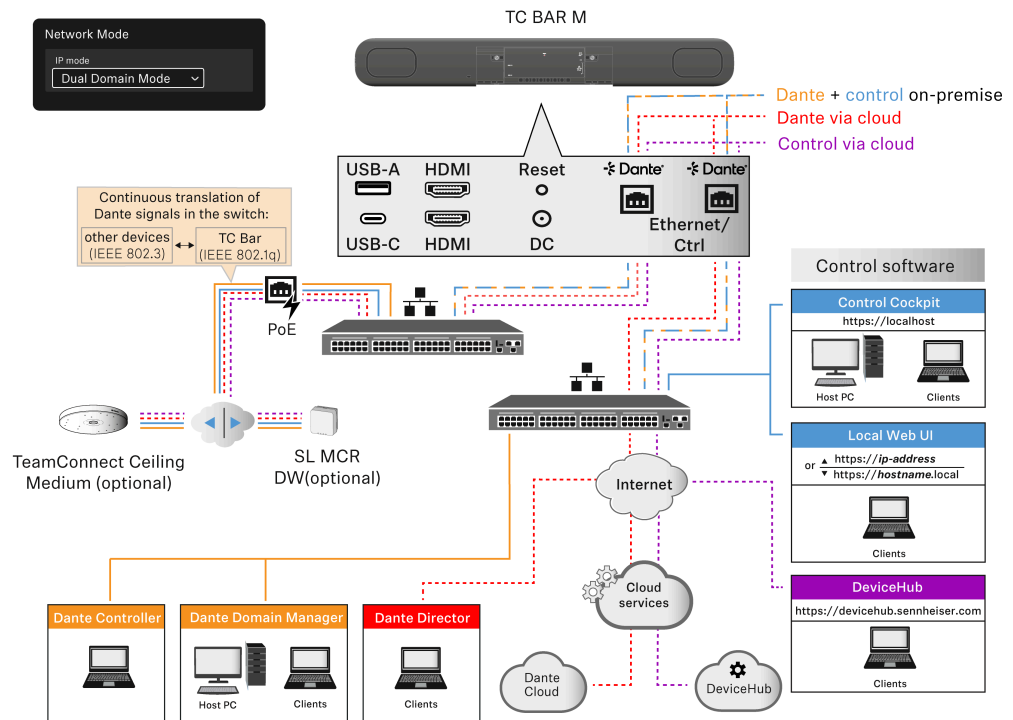

**Alternative connection option:**

The enhanced devices (e.g., TCC M or MCR) are not connected using the second Ethernet port. Instead, they are connected by an external switch using separate cabling.

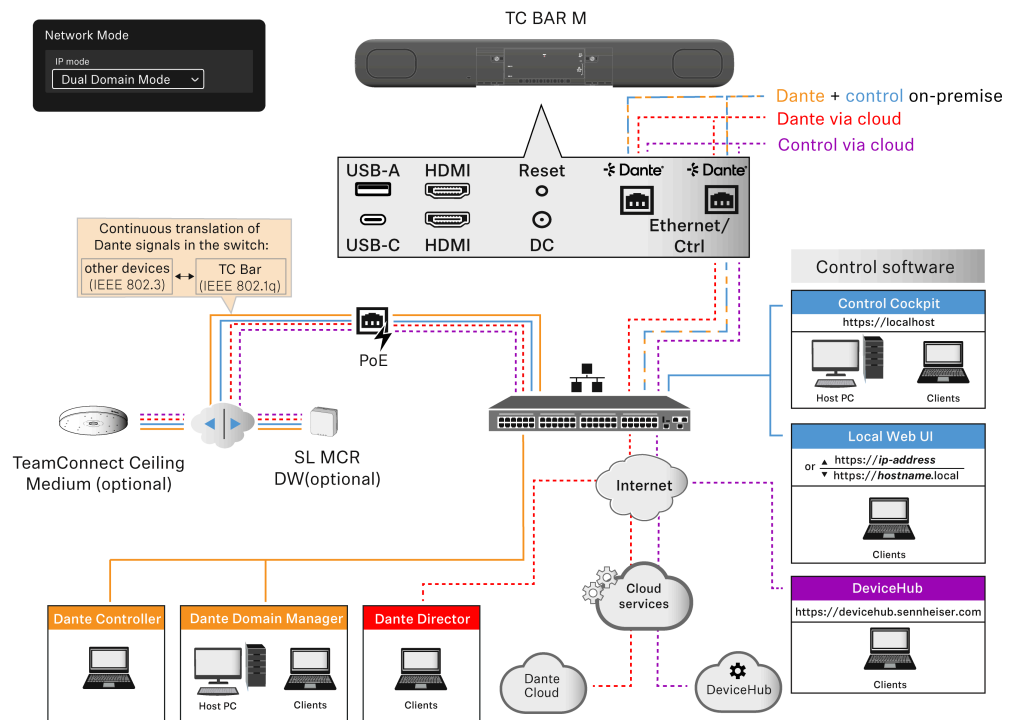



## Split mode

**i** Split mode is available only for the TC Bar M.

This mode is generally used if you receive two different IP and MAC addresses (one for Dante® and one for the control). You want to operate the Dante® network and the control network independently of one another in this manner and use a dedicated switch for each network.

In this mode, the Sennheiser control application and Dante Controller are in different networks and each have different IP and MAC addresses. All data packages are untagged.

- Ethernet connection I: only control
- Ethernet connection II: only Dante®

### **Use this mode if you want to:**

- Configure both the Dante® and the control network using two different switches
- Use two different IPs to address the control network and the Dante® separately
- Control the Dante® network and the control network using two different connections of the TC Bar.

### **TC Bar M:**

- The first Ethernet connection provides an IP address only for the control application network.
- The second Ethernet connection provides an IP address only for the Dante® network.
- Enhanced products can be addressed using both networks.



**i** Always make sure to connect the TC Bar M to two different networks that do not run through a common switch (see [Danger of network loops](#)). Otherwise, there is a danger of a network loop occurring.

**Example:**

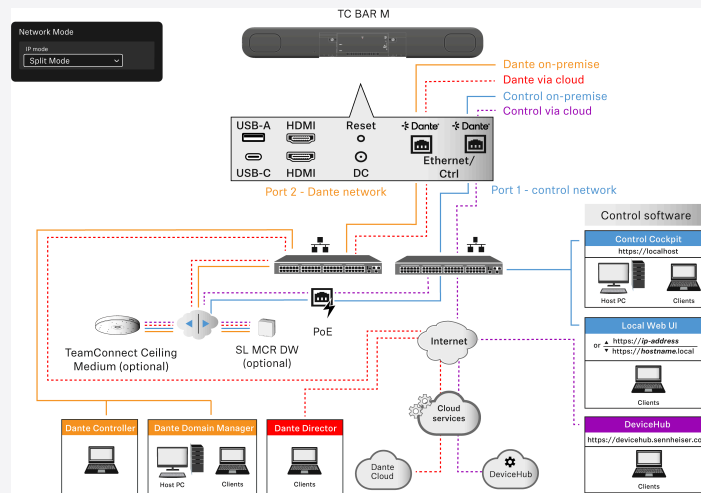



## Danger of network loops

A network loop occurs when a network has more than one active path that takes information from the same source to the same destination.

The information runs in loops and is amplified via the additional path instead of stopping at the destination. Network loops can cause slow, irregular Internet connections or network failures.

Network loops can arise in particular through improper connection of the TC Bar M.

### TC BAR M

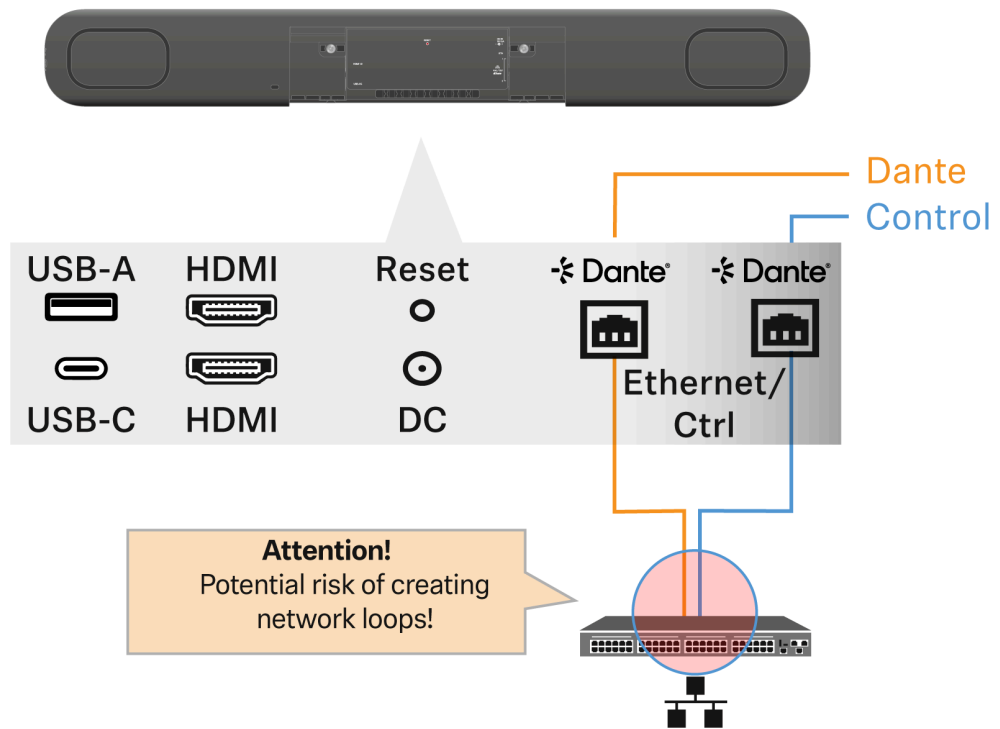



**i** Always make sure to connect the TC Bar M to two different networks that do not run through a common switch. Otherwise, there is a danger of a network loop occurring.

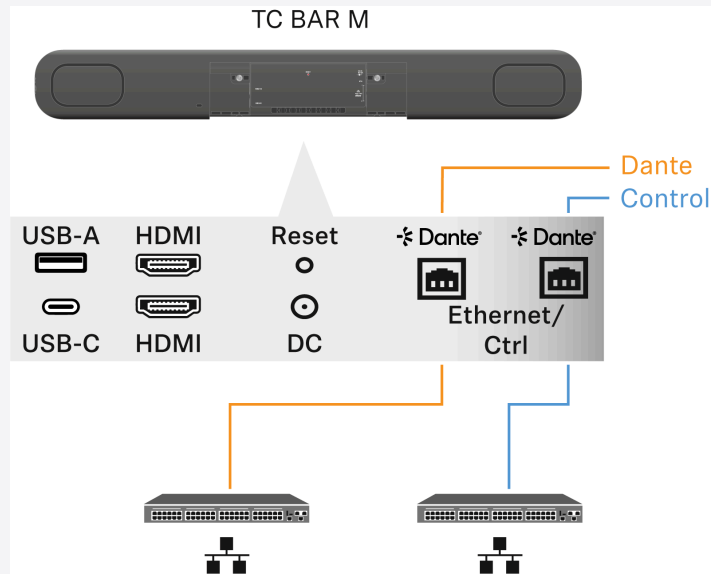

#### Examples

1. Both cables coming from the two connections of the TC Bar M are inserted into the same network switch.
  - Always make sure to connect the TC Bar M to two different networks that do not run through a common switch:
    - Ethernet I: Sennheiser control application network
    - Ethernet II: Dante® network
2. Both ends of an Ethernet cable are connected to the same router.
  - Remove the Ethernet cable.



## Dante® features for TC Bar S and M

With the built-in Dante Embedded Platform (DEP), the TC Bar integrates media and control of your entire AV system over a single IP network.

The Dante® functionality is deactivated by default and must be activated in the control software (see [Activating Dante® signal forwarding](#)).

The TC Bar offers various inputs and outputs for Dante® and makes it possible to connect several extensions:

### Dante® Input

- 2x Dante® input with AEC on each input

### Dante® Output

#### General:

- 4x Dante® Output:
  - Audio content is only played back when the TC Bars are used as a USB device.
  - Otherwise, the Dante® channels are muted (if the feature Continuous Dante® Stream is disabled)

#### ConferenceOut:

- Mix of NearEnd + Far End (in conference mode and music mode)

#### LocalMicrophoneMixOut:

- NearEnd (in conference mode and music mode)

#### FarEndRefOut:

- Audio data for AEC reference channel for TCC 2 + TCC M solutions

#### ExternalSpeakerOut:

- FarEnd (in conference mode and music mode, if ext. Dante® speaker feature is enabled)

## Dante® features

### Continuous Dante® Stream:

- Enables the continuous transmission of microphone streams over Dante®.



**Dedicated Dante® speaker output:**

- Routes audio to external Dante® speakers and disables the device's internal speakers.

**Dante® connections**

**Ceiling mics:**

- 2x TCC M (medium-sized conference rooms, recommended solution) or 2x TCC 2 (not recommended, as TC Bars are not designed for large meeting rooms)
- 1x TCC 2 and 1 channel of an SL-DW MCR
- 1x TCC M and 1 channel of an SL-DW MCR

**SL-DW or EW-DX:**

- Up to 2 channels SL-DW MCR or EW-DX
- The use of the mixed sum signal of the MCR is not recommended

**i** The TC Bar S has only one network connection. Therefore an additional switch is required in most cases. TC Bar S can in turn be supplied with power via this one port using PoE+.



## Enhanced audio and video coverage

The TC Bar is an audio and video conference system that can be used not only as an independent stand-alone solution but also as a unit in a networked system via the Sennheiser control application.

If there is insufficient audio coverage of the participants in a room, the miking can be enhanced by using additional Sennheiser devices that are connected to the TC Bar. Doing so creates a custom audio network structure that is adapted to the environment in question.

Enhanced microphones (e.g., TeamConnect Ceiling Medium or SpeechLine Multi-Channel Receiver) can be directly connected to the TC Bar M and supplied with power through the integrated Dante® interface.

- i** The control software Sennheiser control application can control several devices at once. As a result, entire system landscapes or custom system solutions for individual rooms can be created and managed. In this manner, the TC Bar can interact with other systems, for example, as a supplementary system in a conference room.

### Enhancement with the TeamConnect Ceiling Medium (TCC M)



TeamConnect Ceiling Medium can extend the range of the audio recording up to an area of 32 m<sup>2</sup> (344 ft<sup>2</sup>). It can be seamlessly integrated into the existing meeting room and does not require any cabling on the tables. The connected devices are configured centrally using the Sennheiser control application. It is possible to adapt different configurations for audio, device, zone, and network settings manually and customize them for a connected audio system.



You can find additional information about the product TeamConnect Ceiling Medium here: [sennheiser.com/teamconnect](https://sennheiser.com/teamconnect).

### Enhancement with the SL Boundary microphone (114-S DW)

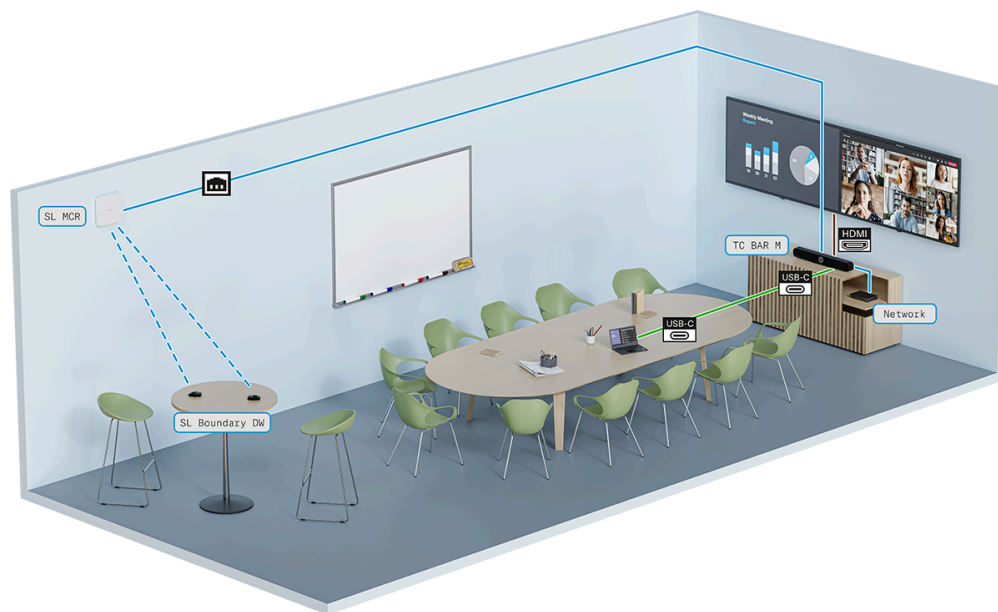

In conference rooms with flexible interiors, audio coverage can be easily achieved with the SL Boundary 114-S DW microphones. The participants, who are distributed among different locations in the room, enjoy flexibility with full microphone coverage. The SL Boundary 114-S DW microphone can be operated with an SL Rack Receiver DW or a SpeechLine Multi-Channel Receiver. The microphone is optimized for speech transmission in conference rooms and provides extremely flexible usage options, since it has no cables at all. You can find more information about the product SL Boundary 114-S DW here: [SL Boundary 114-S DW](#).



### Enhancement with the SL Handheld DW microphone



During conferences with a moderator, the best way to set up the transmission is using an SL Handheld DW microphone. That way, the focus is always on the speaker, who can move freely in the room. The slim but robust SL Handheld DW is optimized for speaking during presentations, when every word counts.

The SL Handheld DW transmits the moderator's speech to an SL DW Rack Receiver or an SL DW Multi-Channel Receiver that is connected to the TC Bar.

You can find more information about the product SL Handheld DW here: [SpeechLine Wireless](#)



## Enhancement with MobileConnect



With MobileConnect, every user can join the audio stream using an access code and use their own device to participate in a meeting. Regardless of where the participants are in the room, they experience high-quality audio support from Unicast audio stream and can participate in the discussion through bidirectional communication via a built-in microphone on the mobile device they are using.

Transmission takes place via a MobileConnect station that is connected to the TC Bar. The MobileConnect station provides an audio streaming service with its own access for mobile devices and transmits the signals to the connected TC Bar during conferences.

You can find more information about the product SL Handheld DW here: [MobileConnect](#)



### Enhanced video coverage with a USB camera

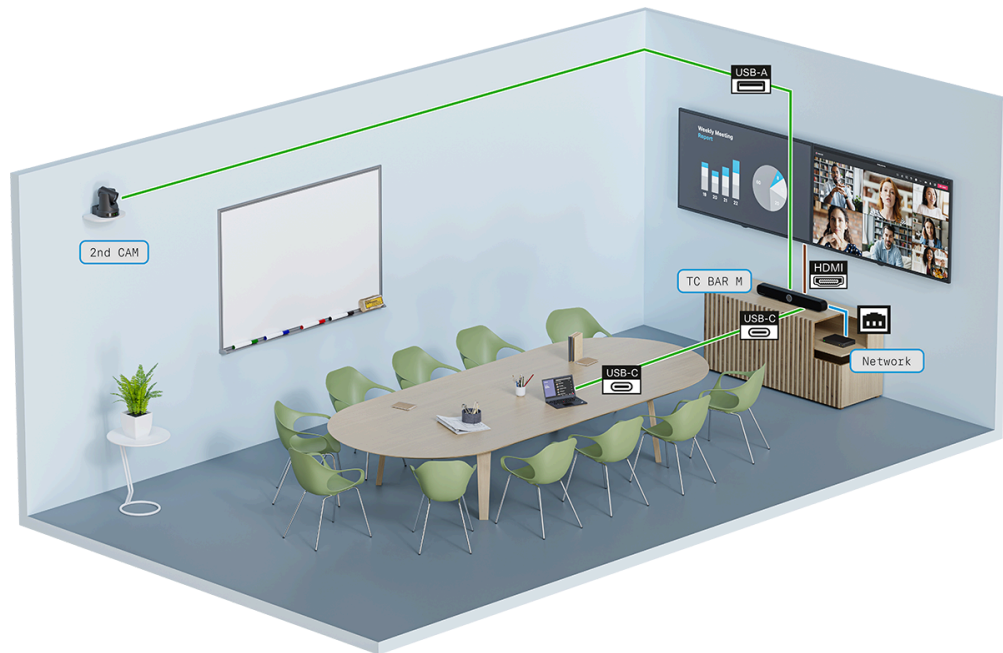

An additional USB camera can be added to extend the camera view of the TC Bar to record all conference participants from their different perspectives in a room.

The external PTZ (pan tilt zoom) camera from a third-party provider can be directly connected to the TC Bar using a USB-A connection. In this case, the user can select either the TC Bar's internal camera or the external PTZ camera for an additional whiteboard or presenter view.

**i** Smart camera switching is not supported at this time.



## Status information about energy consumption

According to the ecological design requirements of Directive 2009/125/EC on products relevant to energy consumption, the TC Bar complies with the following standard(s) or document(s): Commission Regulation (EU) 2023/826.

### Classification

The TC Bars are classified as follows:

- TC Bar S: LoNA (networked device)
- TC Bar M: networked device with HiNA functionality

### Available energy saving modes

**i** To set the TC Bar into a specific mode, certain prerequisites must be met. In its factory-default state, the TC Bar automatically enters the **Network Standby Mode** as soon as the required prerequisites are met. Further optional modes can be activated for certain use cases via the control application.

- **Network Standby Mode** (default)
  - In the control software shown as: **Eco Mode**
  - This mode is the default mode in the factory-delivered state.
  - The mode puts the device into a state with minimal power consumption to ensure availability and reachability over Ethernet.
  - Remote wake-up is possible.
- **Standby Mode** (optional)
  - In the control software shown as: **Low Power Mode**
  - This optional mode puts the device into **Deep Sleep** mode to reduce power consumption.
  - Waking the device requires a manual power-on operation.
  - Remote wake-up is not possible because there is no longer a network connection.
- **Operational Mode** (optional)
  - In the control software shown as: **Always On Mode**
  - This mode is explicitly recommended for devices that must be available 24/7 for administration purposes, which is performed primarily remotely.
  - If the **Always On Mode** is selected in the control software and the increased power consumption is explicitly confirmed by the user, the device will no longer be automatically placed into any ECO mode.
  - The device remains constantly in an operational state and can be accessed at any time.



## Power consumption

Mode	TC Bar S	TC Bar M
<b>Network Standby Mode</b> (After less than 20 minutes, having achieved the required, see <a href="#">prerequisites</a> )	≤ 2.00 W	≤ 2.00 W (unless an Ethernet port is connected) ≤ 7.00 W (as long as at least one Ethernet port is connected)
<b>Standby Mode</b> (After being explicitly enabled in the control software as <b>Low Power Mode</b> and with <u>all</u> connections inactive for at most 2.5 hours, see <a href="#">prerequisites</a> )	≤ 0.50 W	≤ 0.50 W
<b>Operational Mode</b> (After explicitly enabled in control software as <b>Always On Mode</b> )	max. 30 W	max. 72 W

## Standby modes

This chapter describes the device's automatic power-saving and standby modes and the conditions that trigger them.

### Network standby mode

After less than 20 minutes of inactivity, the TC Bar automatically switches to network standby mode, as long as the network interface is no longer in use. The consumption lowers to ≤ 2.00 W.

If none of the connected network interfaces (Ethernet, USB-C, Bluetooth®, Wi-Fi) is in use, the consumption lowers to ≤ 7.00 W.

**Network standby mode is activated as soon as the following requirements are met for the interface in question:**

- There is no active data transfer via Wi-Fi **AND**
- There is no active data transfer via the connected Ethernet connection **AND**
- There is no active data transfer via Bluetooth® **AND**
- No USB-C cable is connected.

### Standby mode

**i** As soon as the USB-C® cable is not connected to the device, the USB-C® port is automatically inactive.

The TC Bar automatically switches to standby mode after a maximum of 2.5 hours once all connections are inactive. The consumption lowers to ≤ 0.50 W.



**Standby mode is activated as soon as the following requirements are met and the time mentioned above has lapsed:**

- Bluetooth® is deactivated, or there is no active connection with a paired device **AND**
- Wi-Fi is deactivated, or there is no active connection with a paired network **AND**
- Nothing is connected to the USB-C® port of the TC Bar **AND**
- No Ethernet cable is connected.



## Activating/deactivating network ports

### Activating/deactivating Bluetooth®

- **Activation:**
  - In the control application, activate the switch **Bluetooth** on the tab **TC Bar > Network**.
- **Deactivation:**
  - In the control application, deactivate the switch **Bluetooth** on the tab **TC Bar > Network OR**
  - In the control application, click **Factory Reset** under **TC Bar > Device** and confirm with **OK OR**
  - Holding down the reset button on the back of the device at least 7 seconds,

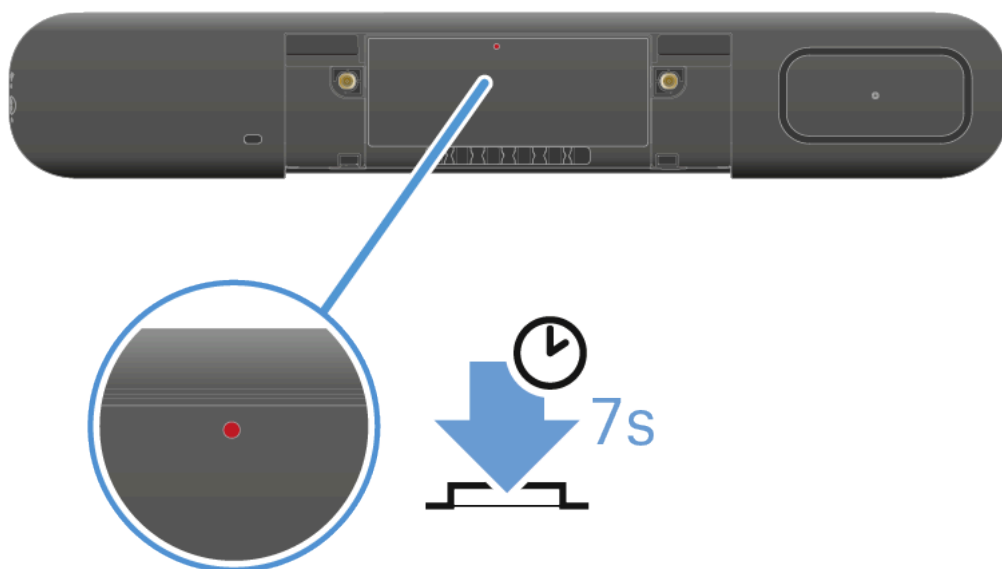

- You can find more information in the chapter [Activating Bluetooth®](#).

### Activating/deactivating HDMI®

- **Activation:**
  - In the Sennheiser control application, activate the switch **HDMI** on the tab **TC Bar > Device AND** connect a USB-C cable to your TC Bar **OR**
  - In the control application, click **Factory Reset** under **TC Bar > Device** and confirm with **OK**.

**i** It is not possible to activate the HDMI function in the selected device profile  
**Microsoft Teams**



- **Deactivation:**
  - In the Sennheiser control application, deactivate the switch **HDMI** on the tab **TC Bar > Device OR**
  - Remove the USB-C cable from the TC Bar **OR**
  - In the Sennheiser control application, activate the device profile **Microsoft Teams** on the tab **TC Bar > Device > Device Profile.**
- You can find more information in the chapter [Connecting the TC Bar to an external screen \(optional\)](#).

### Activating/deactivating Ethernet:

- **Activation:**
  - Insert the device's Ethernet cable into a network port and connect the TC Bar with a far end.
- **Deactivation:**
  - Remove all of the device's Ethernet cables from the network ports.
- For additional information on initial configuration in the control application, see [Monitoring & Controlling](#).

### Activating/deactivating USB:

**i** The USB-A port becomes active only once a USB-C cable has been connected to the TC Bar.

- **Activation:**
  - Insert one end of the USB-C cable into the USB-C socket of the TC Bar and the other end into the USB-C socket of the device/conference system to be used.
- **Deactivation:**
  - Remove the USB-C cable from the TC Bar and/or the device/conference system in use.



## Third-party access

You can enable third-party access in the control application to operate the TC Bar via an API.

The TC Bar can also be addressed by third-party applications through a media control protocol. For this to be possible, access for third-party providers must be activated in the Sennheiser control application and protected with a password.

The full range of functions and list of callable methods can be found in the media control protocol for the TC Bar. The general description for using third-party applications and product-specific API documentation can be found on the website [API documentation for Sennheiser products](#).



## Licenses

All valid licenses for the product TeamConnect Bar.

### TRADEMARKS

#### Bluetooth®

The Bluetooth® word mark and logos are registered trademarks owned by Bluetooth® SIG, Inc., and any use of such marks by Sennheiser electronic SE & Co.KG is under license. Other trademarks and trade names are those of their respective owners.

#### HDMI®

The terms HDMI, HDMI High-Definition Multimedia Interface, HDMI Trade dress, and the HDMI logos are trademarks or registered trademarks of HDMI Licensing Administrator, Inc.

#### Audinate®, Dante®

Audinate® is a registered trademark of Audinate Pty Ltd. Dante® is a registered trademark of Audinate Pty Ltd.

#### DisplayLink®

DisplayLink® is the registered trademark of DisplayLink® Corp. in the EU, the US, and other countries.

#### USB-C® trademarks

USB Type-C® and USB-C® are registered trademarks of USB Implementers Forum. USB 2.0 Type-C™ is a trademark of USB Implementers Forum.

#### Windows®, Microsoft Teams

Microsoft Teams and Windows® are trademarks of the Microsoft group of companies.

#### Android™

Android™ is a trademark of Google LLC.

### LICENSE STATEMENT/SOURCE CODE STATEMENT

#### Software code of third parties

This product and its respective software include software code developed by third parties.

#### Accessibility of the software code and licensing agreement

Please visit <https://www.sennheiser.com/support/open-source> or scan the QR code to access all relevant information on the licensing agreement and to view our offer to provide the open source code for the product.



The product firmware and the supplementary license conditions of the open source code used can also be accessed via the freely available Sennheiser Control Cockpit Software and before manually downloading a firmware version under <https://www.sennheiser.com/tc-bar> **Downloads > Firmware Updates**.

- i** By accepting the licensing agreement shown here, you also acknowledge that silent Windows® updates will be serviced to your device, and you accept the responsibility to visit the license text agreement page following the QR Code provided or at the following url: <https://www.sennheiser.com/support/open-source>.



## 3. Instruction manual

Detailed description of mounting, commissioning, operation, maintenance, and transport of the product.

### Quick start

The TC Bar can be connected in just a few steps and used immediately.

- i** The TC Bar can be used either as a **stand-alone solution** in the meeting room or as a **network solution** in an existing network structure.

#### Stand-alone



- Connection via USB-C® (see [Connecting the TC Bar to a device \(stand-alone solution\)](#))
- Restricted functions are available only via the remote control (see [Product overview - remote control](#))
- Configurable via local webUI (see [Local Web UI \(LUI\)](#))

#### Network



- Integrated into the corporate network (see [Operation as a networked conference system](#))
- Configurable via local webUI (see [Local Web UI \(LUI\)](#))
- Configurable via central control application (see [Control software](#))

#### Stand-alone solution

- As a stand-alone solution, the TC Bar is directly connected with a device and operated using only a USB-C® connection. Only restricted functions are available in this operating mode (see [Operation as a stand-alone solution](#)).
- You can use the embedded local WebUI (firmware version  $\geq 2.0.0$ ) to quickly and easily configure and control your device.



### Network solution

- As a unit in the network, the TC Bar can be initially assigned to a control instance and managed via the respective application for seamless integration into your corporate network (see [Control software](#) and [Operation as a networked conference system](#)).

### To install the TC Bar and use it immediately:

#### 1. Unpack the TC Bar

- ▶ Unpack the TC Bar completely and make sure the delivery includes everything it should (see [Scope of delivery](#)).
- ▶ Remove the protective film attached to the camera lens.
- ▶ Mount the TC Bar as per the possible mounting options (see [Mounting options](#)).

#### 2. Connect the TC Bar to the power supply system.

- ▶ Insert the plug of the DC power supply unit into the **DC IN** socket of the TC Bar and guide the cable through the cable sheath (see [Connecting the TC Bar to the power supply system and starting it](#)).
- ▶ Plug the AC power supply unit into the wall socket (see [Connecting the TC Bar to the power supply system and starting it](#)).

#### 3. Connect the TC Bar to the PC/MAC via USB

- ▶ Plug the USB-C® cable into the TC Bar (see [Connecting the TC Bar to the power supply system and starting it](#)).

**i** The TC Bar S is a power-consuming PoE+ device (powered device) and can be operated using no more than the network cable. For continuous power supply, we recommend always connecting the power supply unit included in the delivery (see [Connecting the TC Bar to the power supply system and starting it](#)).

- ▶ Plug the other end of the cable of the USB-C® connection into the device used.
  - ✓ The operating system automatically recognizes and installs the TC Bar. Once the installation has completed successfully, the speakers play a brief sound.



**i** Depending on the conference platform used, interactive configuration tips may appear the first time the TC Bar is used.

**i** Note that **Bluetooth®** is deactivated in the factory settings and can be activated only after the device has been claimed in the control application (see [Control software](#)).

✓ The TC Bar has been installed and is ready for operation.



## Product Overview

### Product Overview - TC Bar S

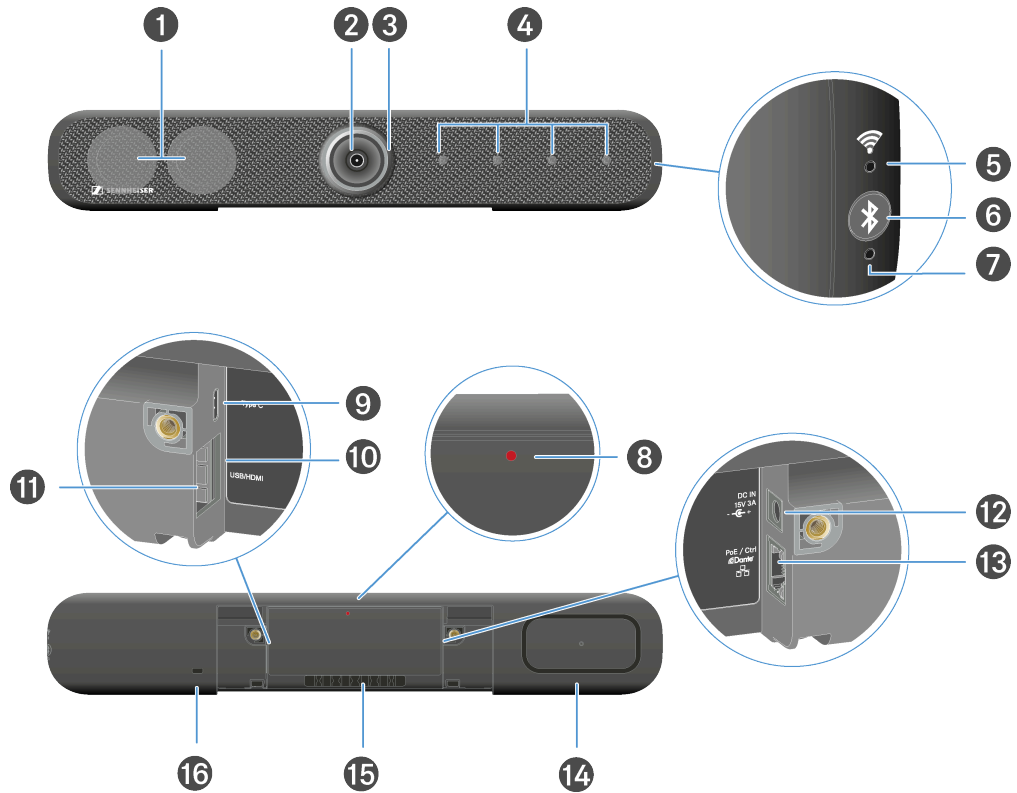

- 1 Stereo speakers
- 2 Camera
  - See [Camera settings](#)
- 3 LED ring
  - See [Camera settings](#)
- 4 Beamforming microphones
  - See [Microphone settings](#)
- 5 Wi-Fi LED
  -



- 6 Bluetooth® pairing initialization
  - See [Activating Bluetooth®](#)
- 7 Bluetooth® LED
  - See [Activating Bluetooth®](#)
- 8 Reset button (factory settings)
  - See [Resetting the TC Bar to factory settings](#)
- 9 Connection socket - USB-C® input
  - See [Connecting the TC Bar to a device \(stand-alone solution\)](#)
- 10 Connection socket - HDMI® output
  - See [Connecting the TC Bar to an external screen \(optional\)](#)
- 11 Connection socket - USB-A input
  - See [Connecting an external PTZ camera](#)
- 12 DC IN socket
  - See [Connecting the TC Bar to the power supply system and starting it](#)
- 13 LAN connection socket RJ45 (PoE+ (PD))
  - See [Network configuration](#)
- 14 Passive radiator
- 15 Cable sheath for connection cable
- 16 Kensington lock



## Product Overview - TC Bar M

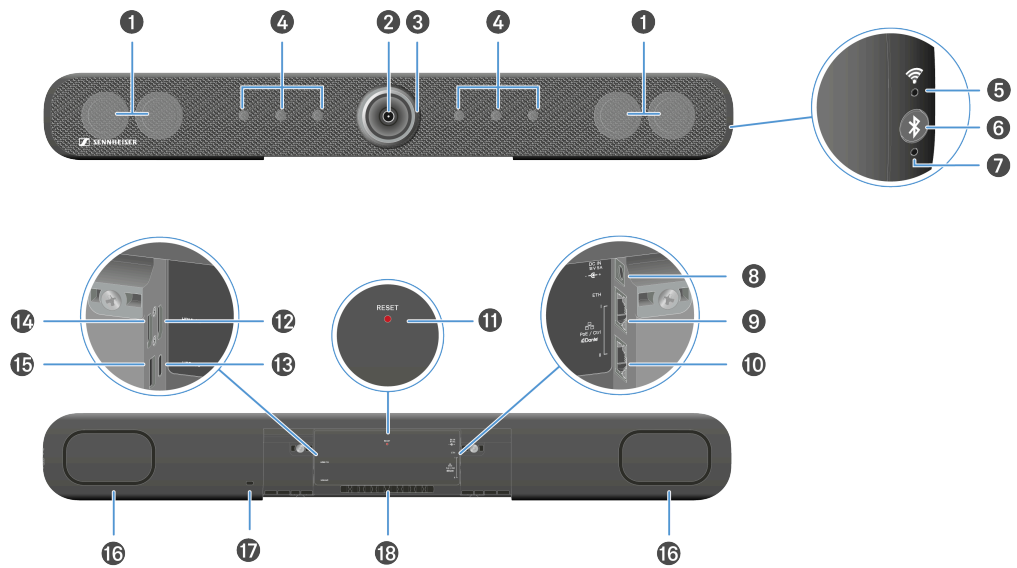

- 1 Stereo speakers
- 2 Camera
  - See [Camera settings](#)
- 3 LED ring
  - See [Camera settings](#)
- 4 Beamforming microphones
  - See [Microphone settings](#)
- 5 Wi-Fi LED
  -
- 6 Bluetooth® pairing initialization
  - See [Activating Bluetooth®](#)
- 7 Bluetooth® LED
  - See [Activating Bluetooth®](#)



- 8 DC IN socket
  - See [Connecting the TC Bar to the power supply system and starting it](#)
  
- 9 LAN connection socket 1 RJ45 Ethernet/control
  - See [Network configuration](#)
  
- 10 LAN connection socket 2 RJ45 Ethernet/control
  - See [Network configuration](#)
  
- 11 Reset button (factory settings)
  - See [Resetting the TC Bar to factory settings](#)
  
- 12 Connection socket - HDMI® output
  - See [Connecting the TC Bar to an external screen \(optional\)](#)
  
- 13 Connection socket - USB-C® input
  - See [Connecting the TC Bar to a device \(stand-alone solution\)](#)
  
- 14 Connection socket - HDMI® output 2
  - See [Connecting the TC Bar to an external screen \(optional\)](#)
  
- 15 Connection socket - USB-A input
  - See [Connecting an external PTZ camera](#)
  
- 16 Passive radiator
- 17 Kensington lock
- 18 Cable sheath for connection cable



## Product overview - remote control

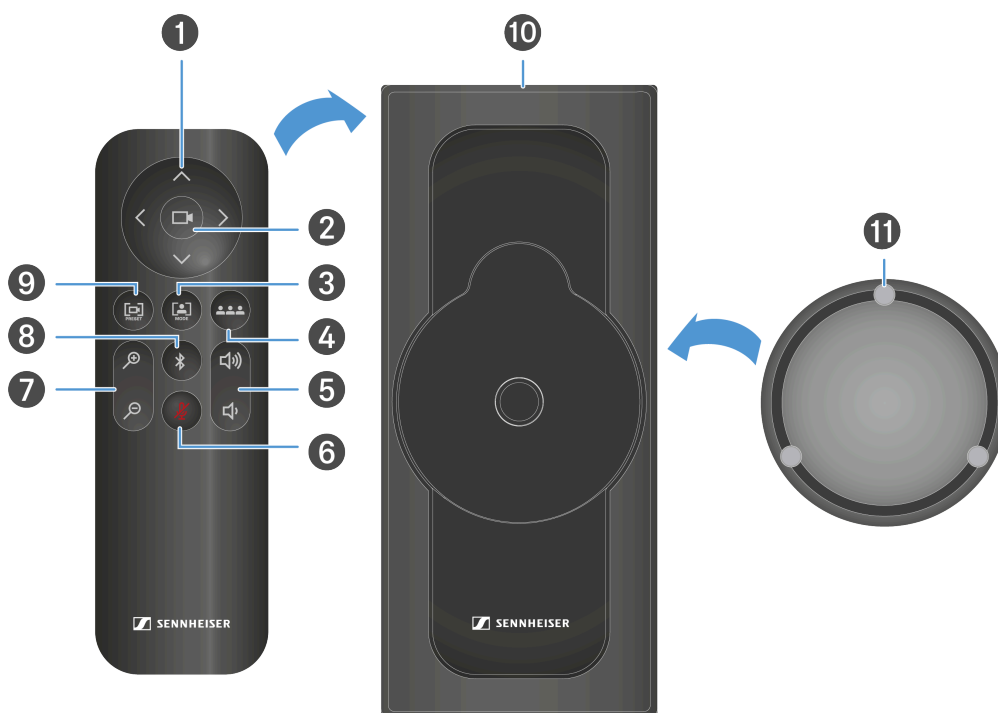

- 1 Camera - pan and tilt function
  - See [Setting the camera position](#)
- 2 Camera - full field of view
  - See [Setting the camera position](#)
- 3 Camera - auto framing mode
  - See [Auto framing](#)
- 4 Camera - person tiling mode
  - See [Person tiling](#)
- 5 Volume control
  - See [Volume settings](#)
- 6 Muting
  - See [Microphone settings](#)



- 7 Camera - zoom
  - See [Setting the camera position](#)
- 8 Bluetooth® pairing initialization
  - See [Activating Bluetooth®](#)
- 9 Camera - save and call up position
  - See [Setting the camera position](#)
- 10 Storage bracket
  - See [Storing accessories](#)
- 11 Magnetic lens cap
  - See [Storing accessories](#)



## Meaning of the LEDs

The TC Bar has several LEDs that display the current audio and video settings, as well as the current connection status.

### LED ring

The LED ring integrated around the camera lens shows different status information about the current microphone, camera and speaker settings. Depending on the application, the interactions are represented using a certain LED display.

The LED ring is divided into three areas:

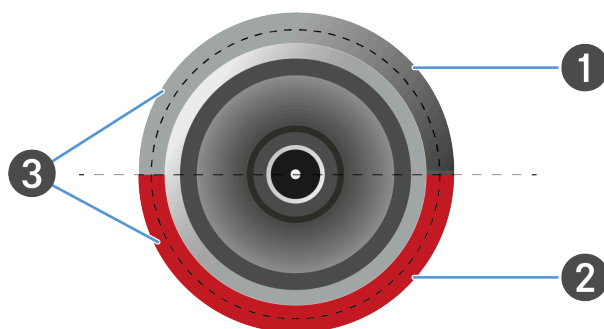

- 1 LED display for camera settings
- 2 LED display for audio settings (microphone)
- 3 LED display for audio settings (speaker volume)

### Side LEDs

The side LEDs show the status of the wireless connections, such as Bluetooth.

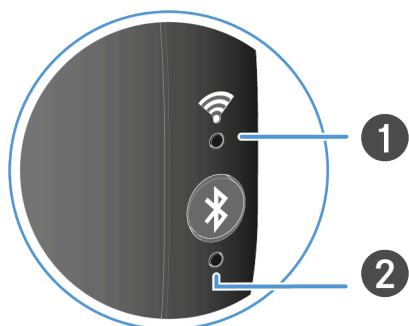

- 1 LED display for Wi-Fi connections
- 2 LED display for Bluetooth® connections



## Camera settings

The upper half of the LED ring shows the current camera settings.

The camera can be controlled using either the remote control or the web interface of the control application.

The LED display can show the status of four modes of the camera functions that are currently set:

- Camera ON/OFF
- Auto framing ON/OFF
- Person tiling ON/OFF

### Auto framing

The **auto framing** function continually focuses on participants in the room, even if they reposition themselves in the room.

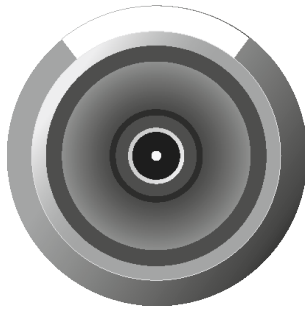

When the function is activated, the lens angle adapts based on the number of people identified in the room and activates continual focus on these people. After that, the camera follows each repositioning of the people in the room, enlarges or reduces the lens angle, and refocuses based on the new circumstances in the room.

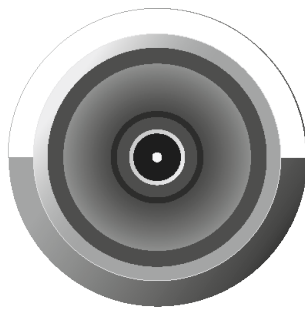

The function is deactivated if the button is pressed again. The camera no longer follows movement in the room.

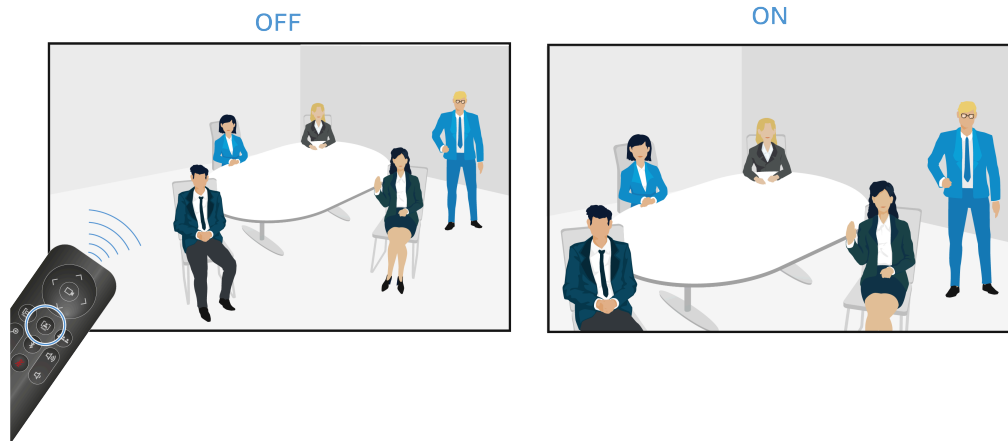

### Person tiling

The **person tiling** function portrays the participants in a manner that is suitable for the far end during a conference. Depending on the number of people in the room, either an overall picture is generated, or each person is shown enlarged in an individual frame.

- i** Grouping: If several people are seated close to one another in a room, they are portrayed as a group and shown in one tile. Please note that the function for simultaneous detection of people in the room is limited to a maximum number of 10.

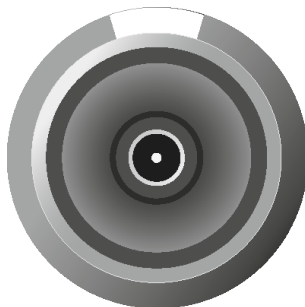

When the function is activated, the lens opens at a large angle with a complete radius of 115°. The first time the button on the remote control is pressed, a complete, wide-angle image is replayed.

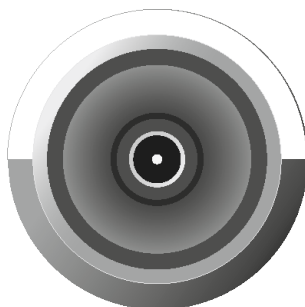

If the button is pressed again, the people recorded are automatically divided into individually tailored frames, and their sections are enlarged. If too many people are present in the room, a custom overall picture is created instead of individual frames.

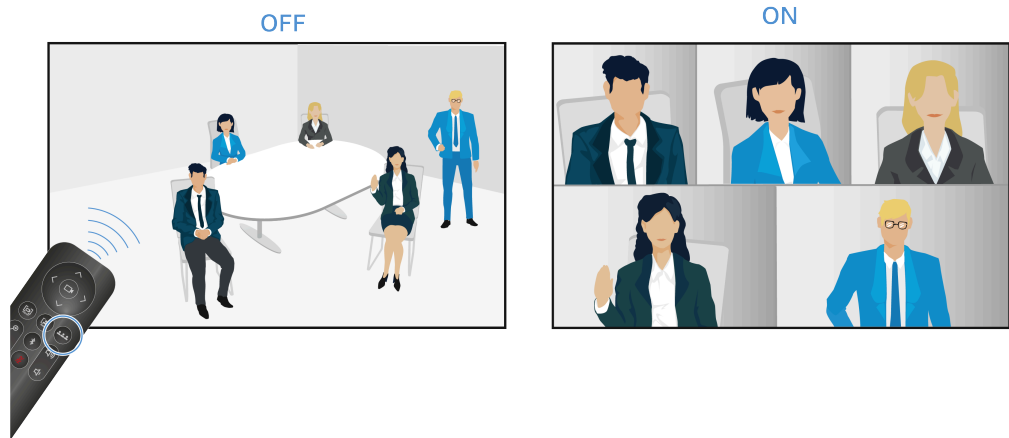



## Microphone settings

The LED for the microphone settings shows the status indicating whether the microphone is on or muted.

### Microphone is on

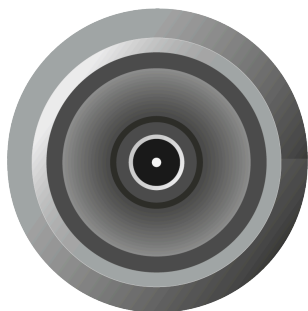

- All LEDs are off.
- The microphone is activated.
- Incoming signals are detected and further processed.

### Microphone is off

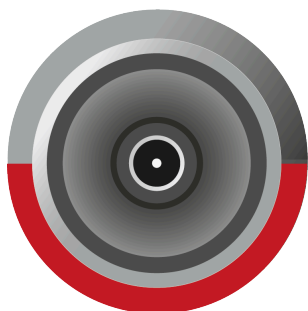

- The LED glows red.
- The microphone is now muted.
- Incoming signals are not processed.



## Volume settings

The LEDs for the speaker settings show the selection of the currently set volume level in 17 increments.

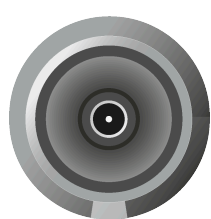

Increment  
00

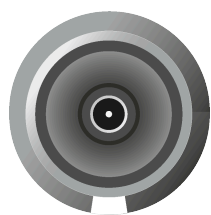

Increment 1

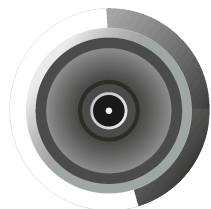

Increment 8

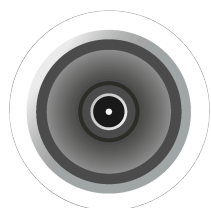

Increment 17



## Wireless connections

The side LEDs show the status of the wireless connections, such as Bluetooth..

### Bluetooth®



- The blue LED flashes. Bluetooth pairing is activated. The device is in pairing mode and can be connected to a device that is capable of Bluetooth.
- The LED remains continuously lit blue. The Bluetooth connection is established.



## Mounting

There are various mounting options for attaching and positioning the TC Bar in a room:

- [Mounting on the wall](#) (bracket included in the scope of delivery)
- [Mounting on the table](#) (bracket included in the scope of delivery)
- [Mounting on a VESA mount](#) (optional accessories required, see [Accessories](#))
- [Mounting on a tripod](#) (bracket included in the scope of delivery, but not the tripod)

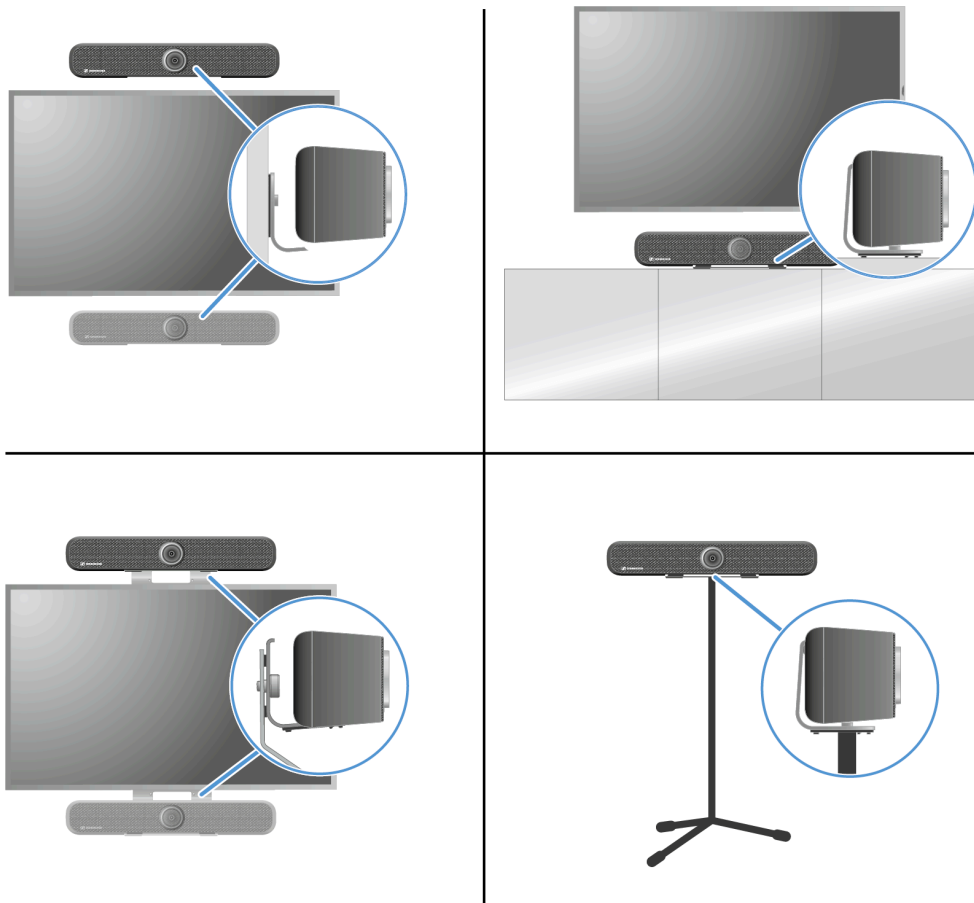

## Safety instructions for mounting

Read and follow these safety instructions for mounting. Keep the safety instructions and always include them when passing the mounting kit on to third parties.

- When mounting the product, observe and follow all local, national and international regulations and standards.
- Do not use the mounting kit in locations where it is exposed to externally generated vibrations.
- Always use the original Sennheiser mounting hardware.
- Have the product mounted by a specialist.
- The specialist must have sufficient professional training, experience and knowledge of applicable provisions, regulations and standards to be able to properly assess



the work assigned to them, identify possible hazards and take appropriate safety measures. All of the safety and mounting instructions below are intended for the specialist carrying out the mounting.

- Use screws and anchors that are appropriate for the particular characteristics of your wall (not included with delivery).
- If different mounting positions are possible, choose the position that will result in the least torque if the product is tilted later.
- In case of any damage or any deviation from these safety and mounting instructions, immediately dismount the product TC Bar S/TC Bar M and the additional mounting hardware used.



## Mounting the TC Bar on the wall

The mounting kit included in the delivery can be used to mount the TC Bar to the wall above or below the screen.

**i** The bracket required for mounting is included in the scope of delivery. The screws and dowels required for mounting are not included in the scope of delivery.

### Scope of delivery

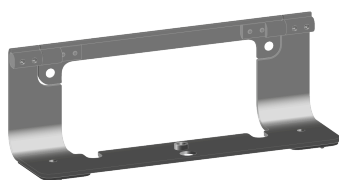

A



B



C

- A Mounting bracket
- B Drilling template
- C Two fastening screws

### To mount the TC Bar on the wall:

- ▶ Remove the enclosed cardboard drilling template from the packaging.
- ▶ Place the drilling template on the desired position on the wall and align it using a level.

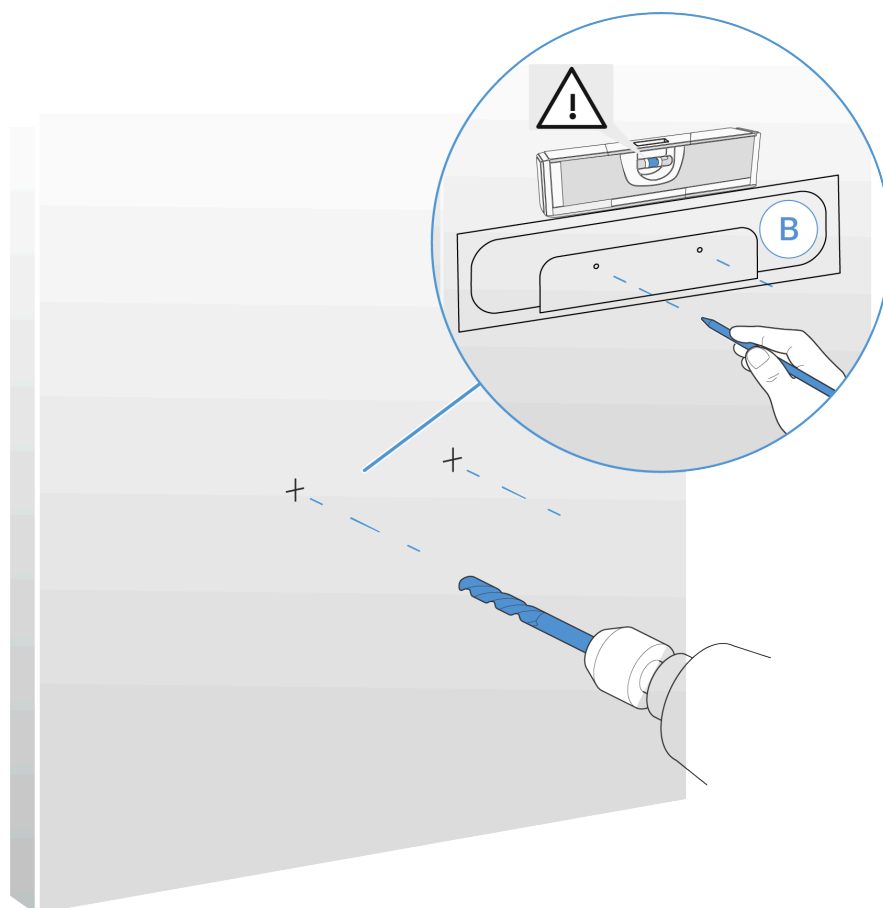

- ▶ Use a sharp pencil or a flat head screwdriver to puncture through the drilling template at the drilling markings and mark the drilling points on the wall in the process.

**i** To securely fasten the TC Bar to the wall, we recommend using a drill with a diameter of at least 8 mm and the appropriate dowels.

- ▶ Drill the holes at the marked points and, depending on the material the wall is made of, insert appropriate dowels into the wall.
- ▶ Tighten the bracket with two screws.

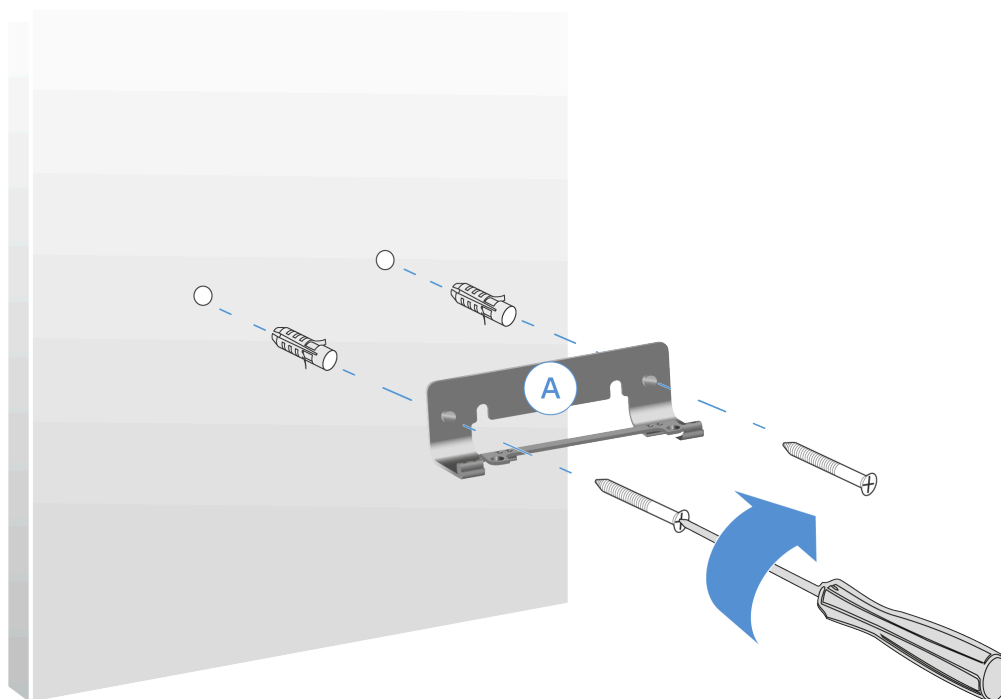

- ▶ Place the TC Bar on the mounted bracket from above and attach the TC Bar using the screws included in the delivery.

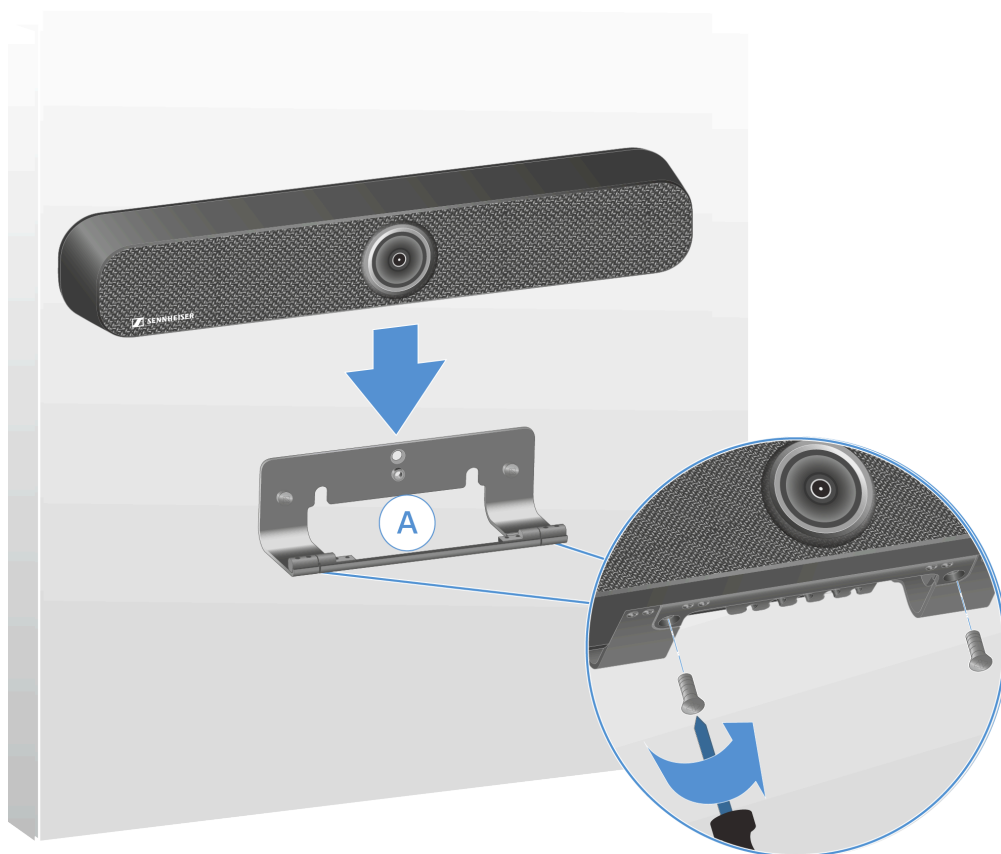

- ▶ Tilt the TC Bar forward slightly and install all connection cables.

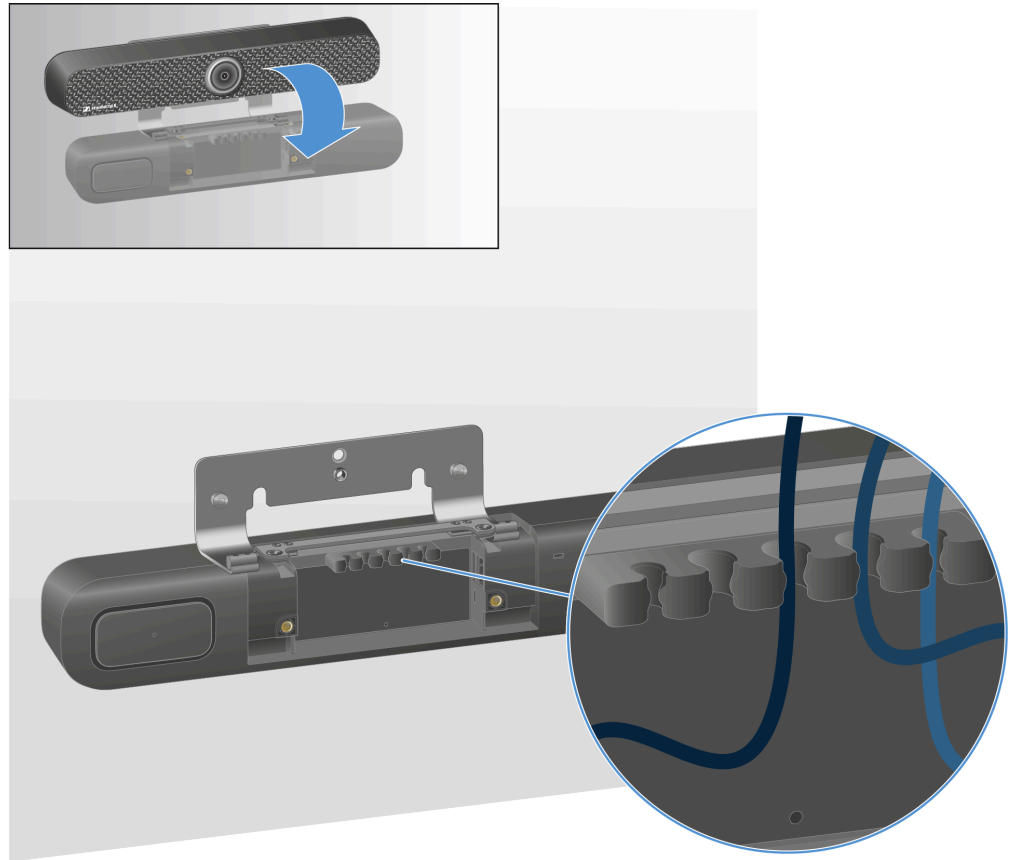

- ▶ Pass the cable properly through the cable guide rail.
- ▶ Position the TC Bar upright again and place it at the appropriate angle.

✓ The TC Bar was successfully mounted on the wall.



## Mounting the TC Bar on a table

The mounting kit included in the delivery can be used to mount the TC Bar to a table or sideboard.

**i** The bracket required for mounting is included in the scope of delivery.

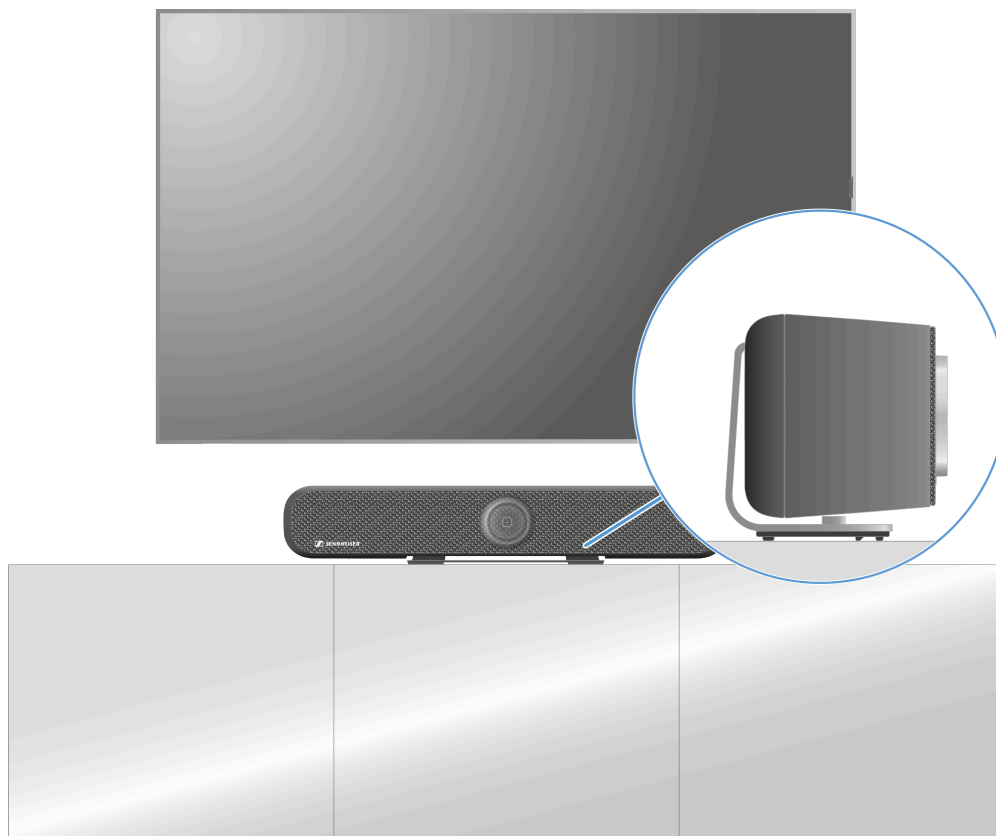

## Mounting the TC Bar on a table

- ▶ Place the TC Bar on a soft surface with its bottom facing up.
- ▶ Place the bracket on the recess on the bottom intended for this purpose and screw the Phillips screws included in the delivery into the thread of the TC Bar.

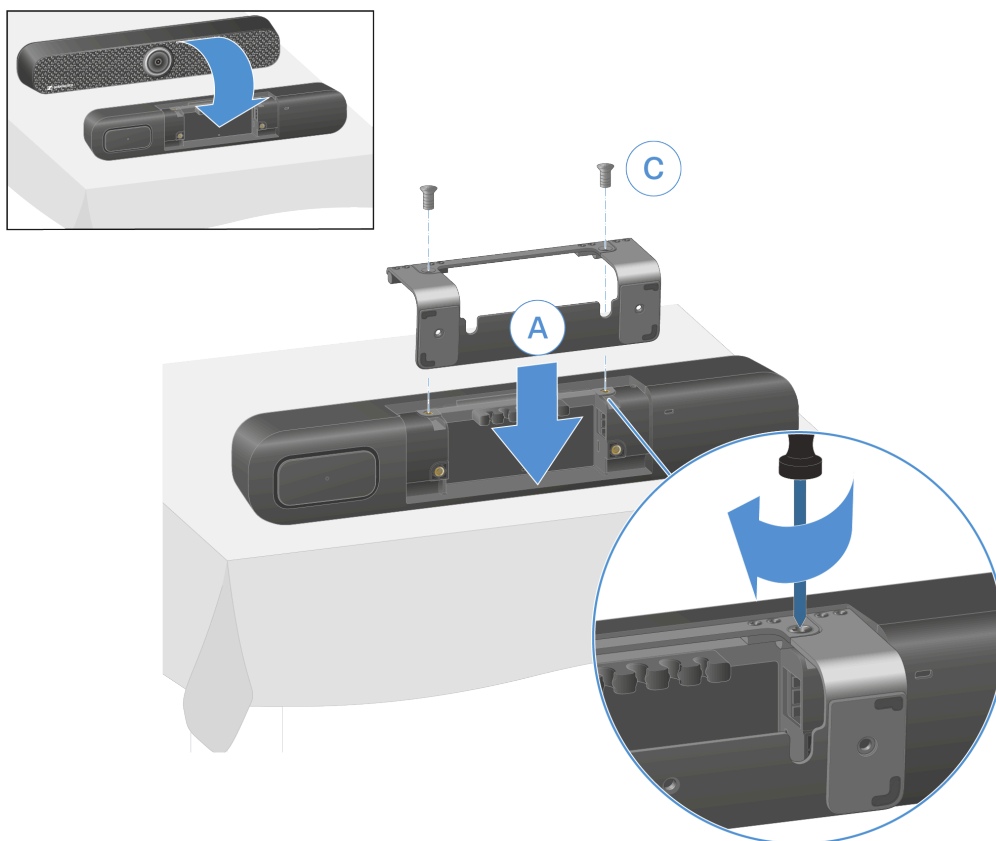

- ▶ Place the TC Bar so its rubber feet are on the table and align it according to the instructions.

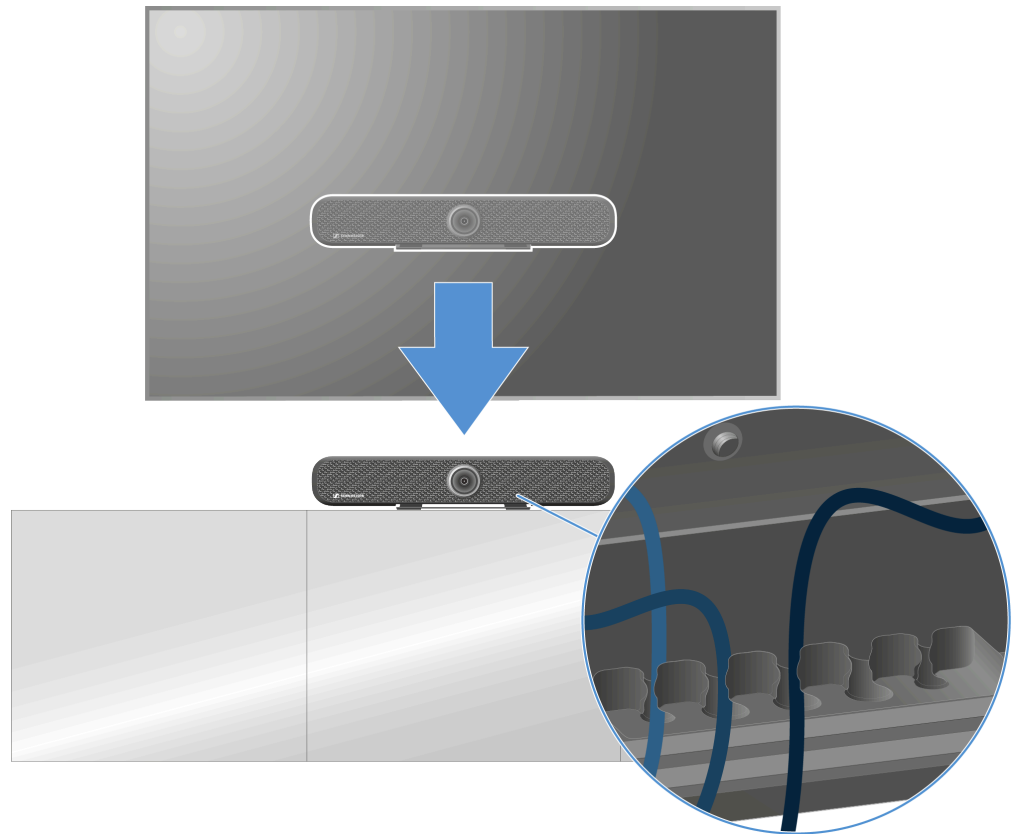

- ▶ Pass the cable properly through the cable guide rail.

✓ The TC Bar was successfully mounted on the table.



## Mounting the TC Bar on a tripod

The mounting kit included in the delivery can be used to mount the TC Bar on a tripod.

**i** The tripod is not included in the scope of delivery.



### Mounting the TC Bar on a tripod:

- ▶ Place the TC Bar on a soft surface with its bottom facing up.
- ▶ Place the bracket on the recess on the bottom intended for this purpose and screw the Phillips screws included in the delivery into the thread of the TC Bar.

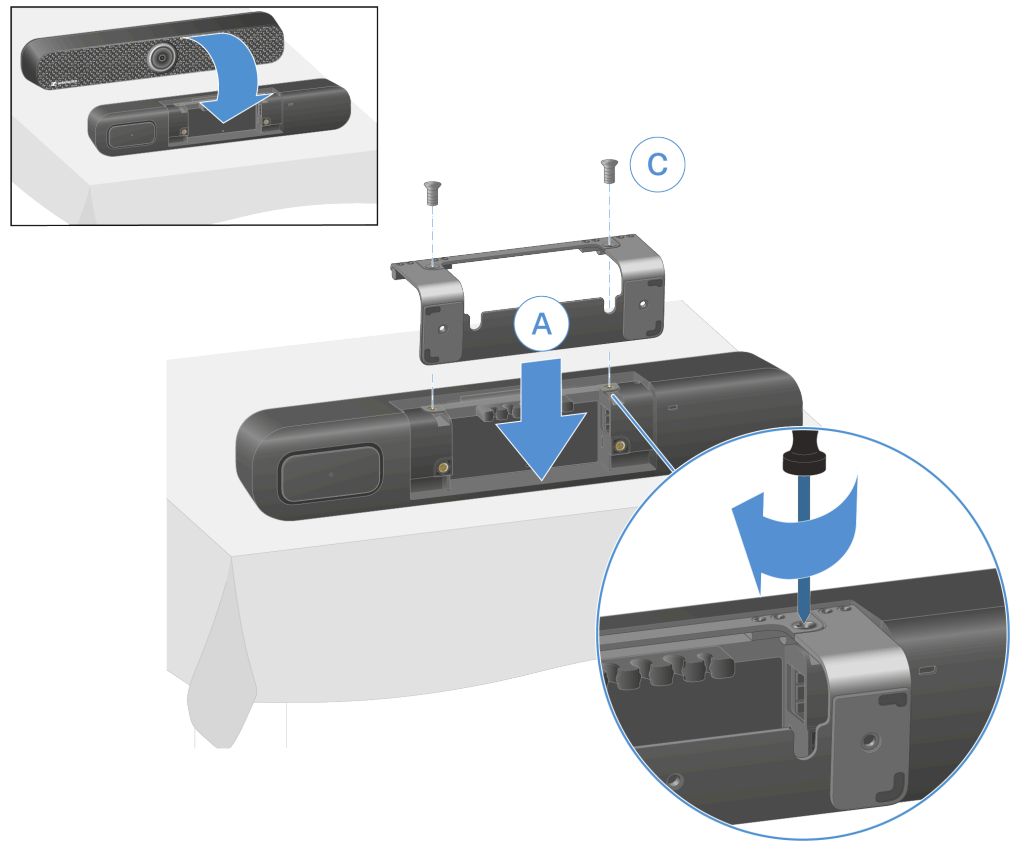

- ▶ Mount the TC Bar on the tripod by mounting the tripod screw (not included in the scope of delivery) in the intended threaded sleeve of the bracket.

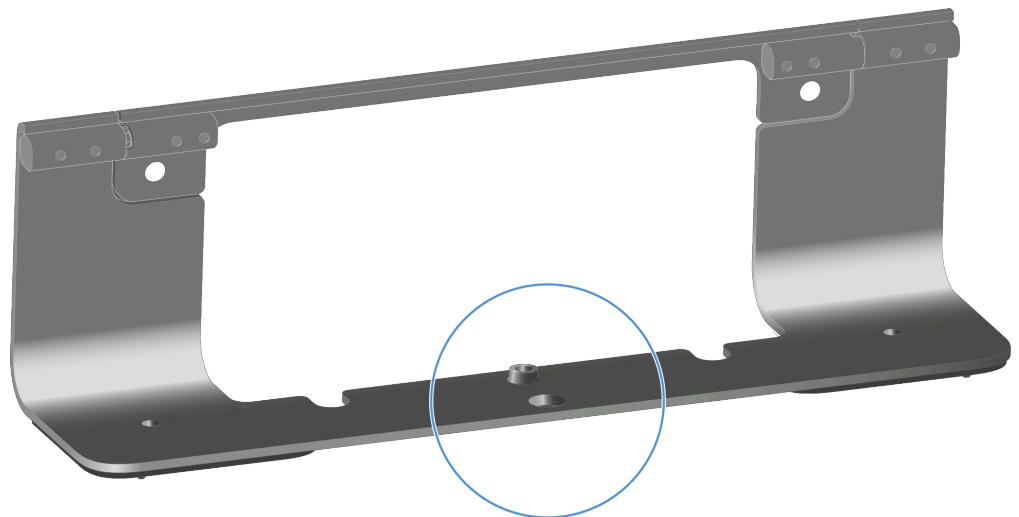

**i** Please note that the tripod screw must have a ¼" UNC tripod thread.

✓ The TC Bar was successfully mounted on a tripod.



## Mounting the TC Bar on a VESA mount

The mounting kit included in the delivery can be used to mount the TC Bar on a VESA mount.

**i** The VESA mount is not included in the scope of delivery and can be purchased separately ([Accessories](#)).

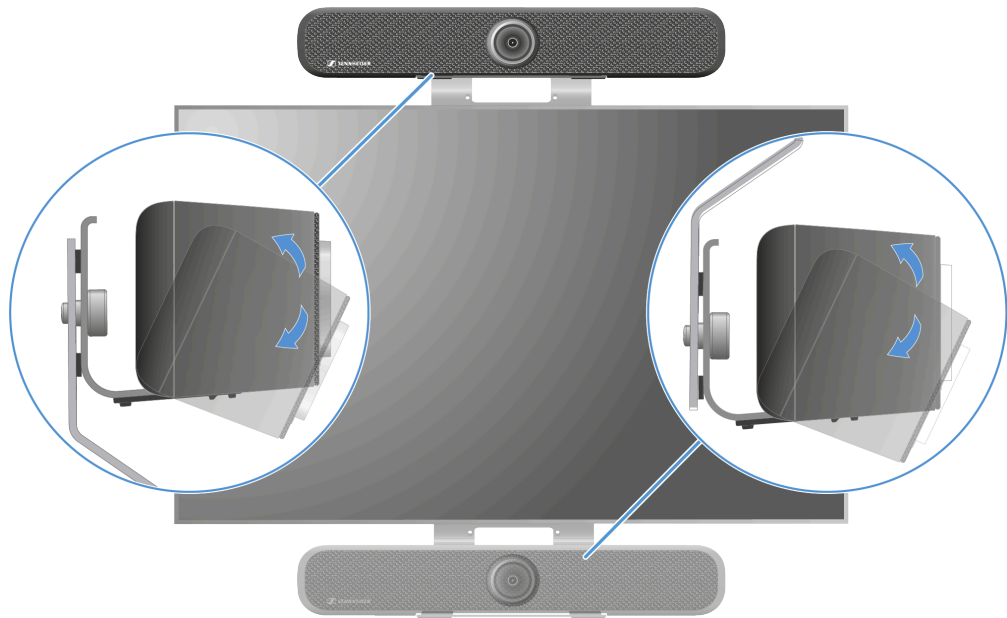

### Scope of delivery

<p>1 x </p> <p>2 x </p> <p>2 x </p> <p>2 x </p> <p>4 x </p>	<p> + </p> <p></p> <p></p>	<p><b>M 6 Set</b></p> <p>4 x  M 6 x 20 mm</p> <p>4 x  M 6 x 40 mm</p> <p>4 x  M 6 x 60 mm</p> <p>4 x  M 6 x 30 mm</p> <p>4 x  M 6 x 50 mm</p> <p>4 x  M 6</p> <p>4 x  M 6</p>	<p><b>M 8 Set</b></p> <p>8 x  M 8 x 15 mm</p> <p>4 x  M 8 x 25 mm</p> <p>4 x  M 8 x 35 mm</p> <p>4 x  M 8 x 45 mm</p> <p>4 x  M 8 x 55 mm</p> <p>4 x  M 8 x 65 mm</p> <p>4 x  M 8 x 8 mm</p> <p>8 x  M 8 x 10 mm</p> <p>8 x  M 8 x 20 mm</p> <p>12 x  M 8</p> <p>12 x  M 8</p>
---	----------------------------	---	--



- i** The mounting displayed here shows the variant placed above the screen. If you mount below the screen, follow the information for the respective steps.

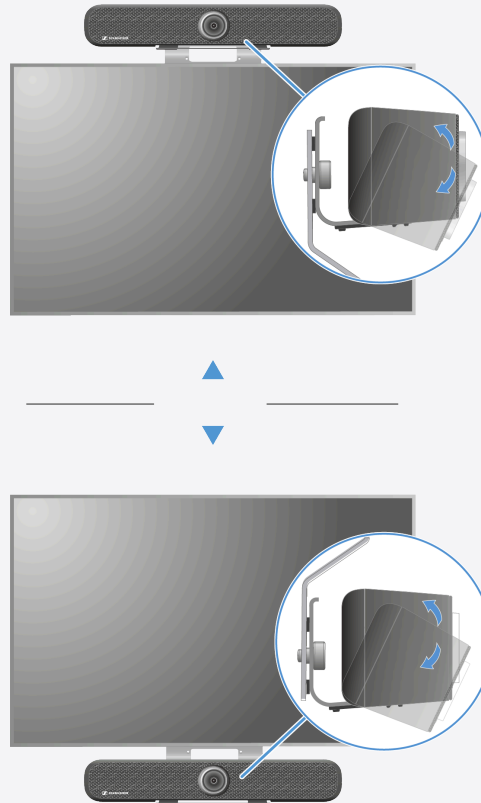



### Pre-mounting the VESA mount

**i** Have the product mounted by a specialist.

- ▶ Place the screen on a soft surface and measure the distances between the mounting threaded sleeves on its back.

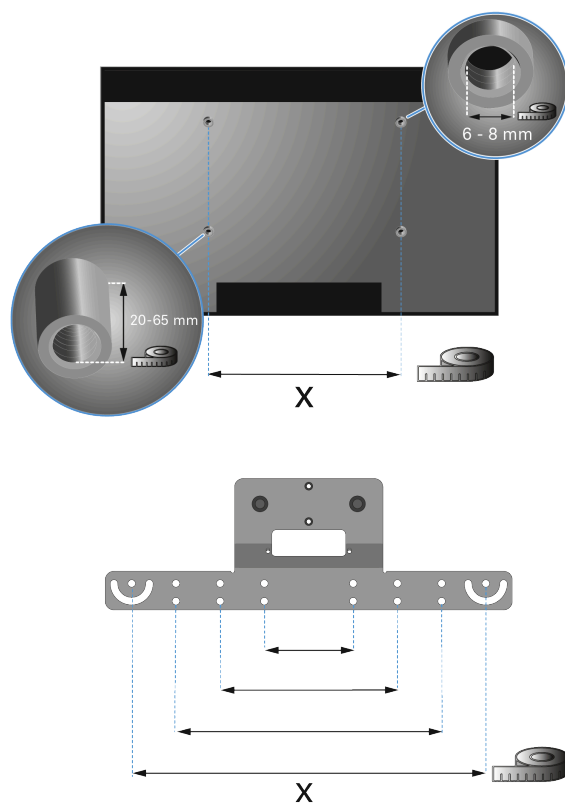

- ▶ Remove the appropriate threaded screws from the mounting kit.

**i** Make sure the screws have the same thread and are long enough. Depending on the size and model of the screen, both the distances and diameters of the threads may vary.

- ▶ Pre-mount the VESA mount with the connection braces as shown.

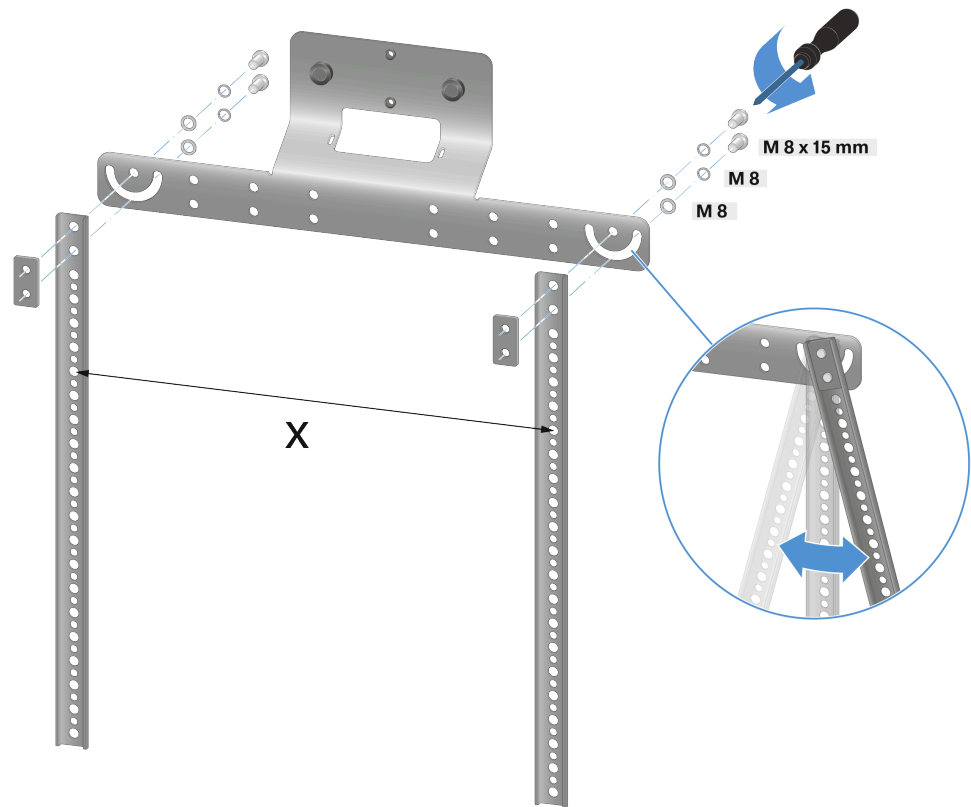

**i** If the screen is positioned diagonally, the angles of the braces can be adjusted accordingly.

✓ The VESA mount has been pre-mounted and is ready for the screen to be attached.



### Attaching the VESA mount to the back of the screen

- i** Please note that when the TC Bar is mounted below the screen, the VESA mount must also be placed below the screen. The mounting displayed in these instructions shows the variant placed above the screen.

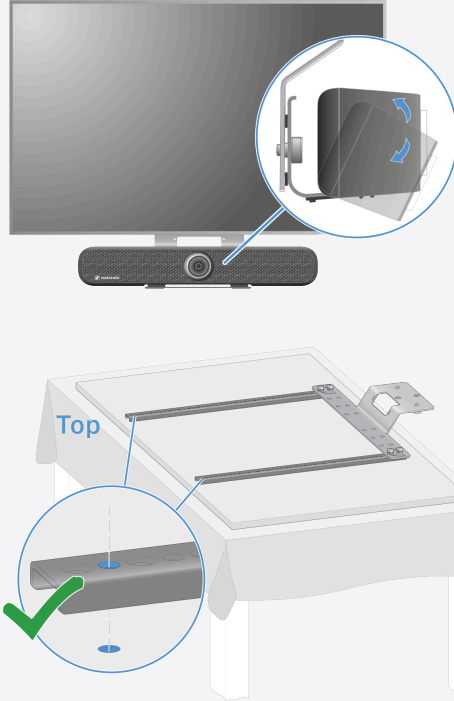

- ▶ Place the prefabricated bracket with metal braces on the back of the screen and make sure the length is sufficient for attachment:

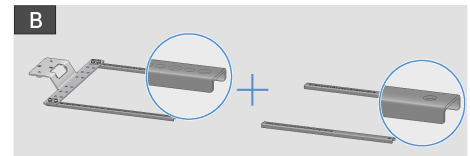
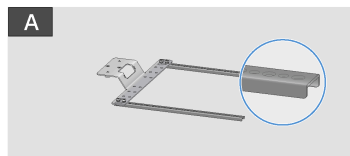

◀ OR ▶

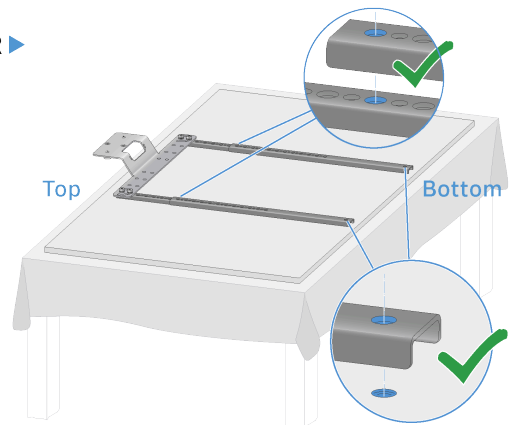
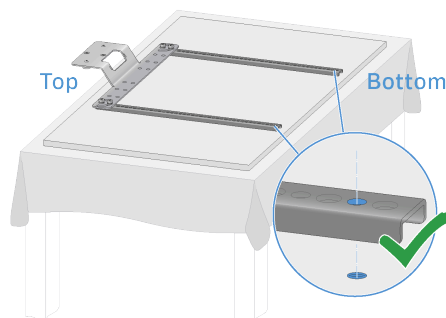



- A: The metal braces are long enough. The intended holes in the metal brace match the threaded holes of the screen.
- B: The metal braces are not long enough. They can be made longer using an extension.

▶ Tighten the prefabricated bracket with the metal braces as shown:

- Version A:

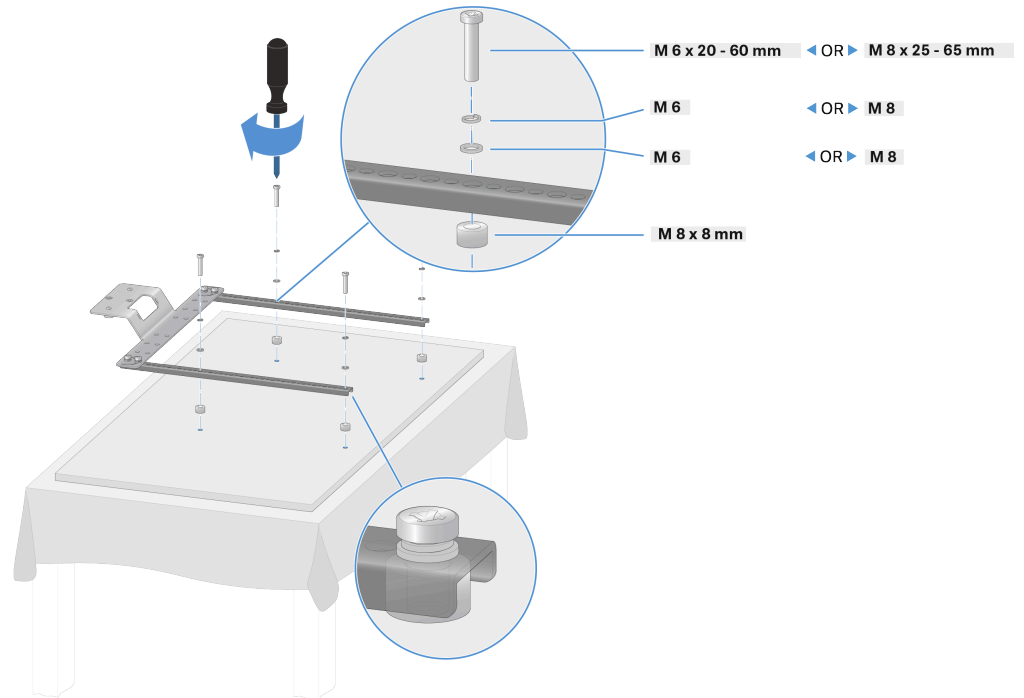

- Version B:

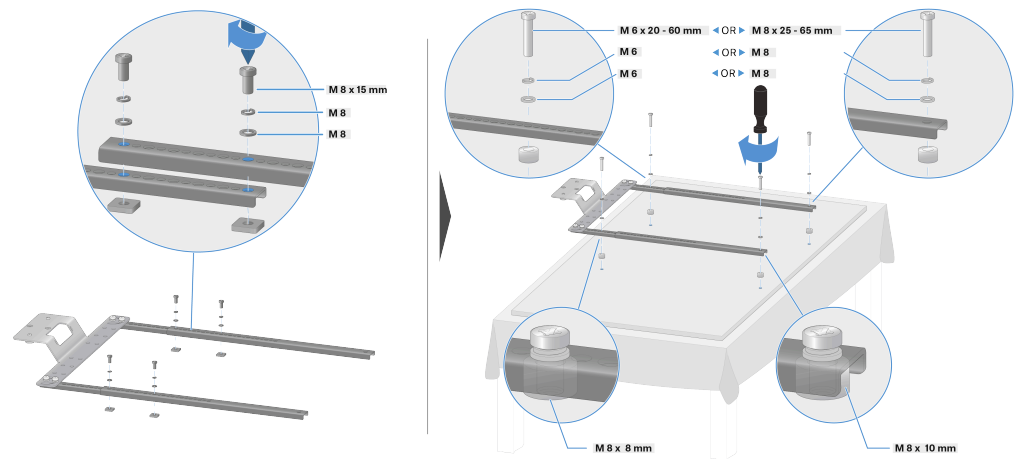

✓ The VESA mount has been attached to the back of the screen.



### Attaching the TC Bar to the VESA mount

**i** For this step, first mount the bracket on the TC Bar (see [Mounting the TC Bar on the wall](#)).

▶ Place the attached bracket, together with the TC Bar, on the hang tab of the VESA mount:

- A: Above the screen

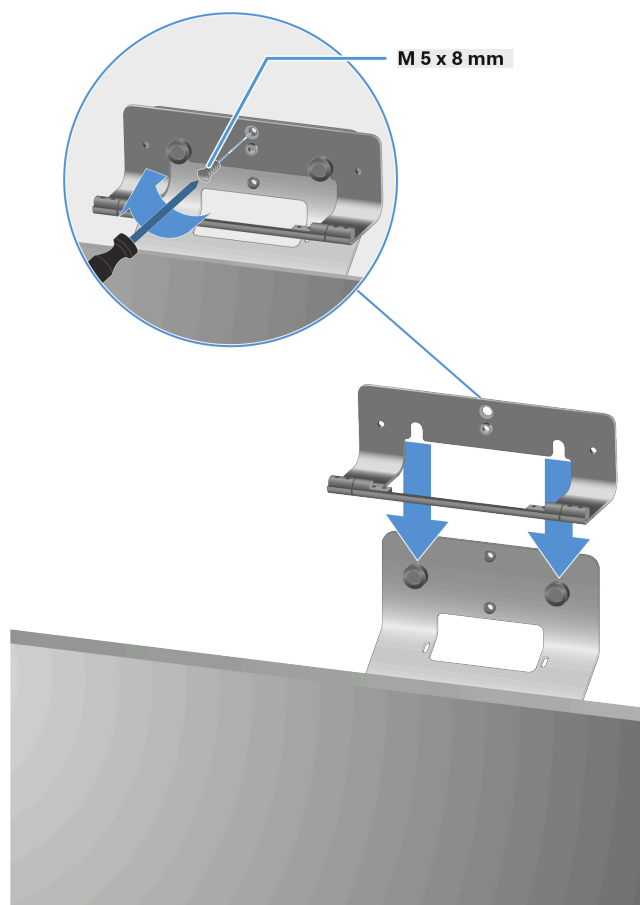



- B: Below the screen

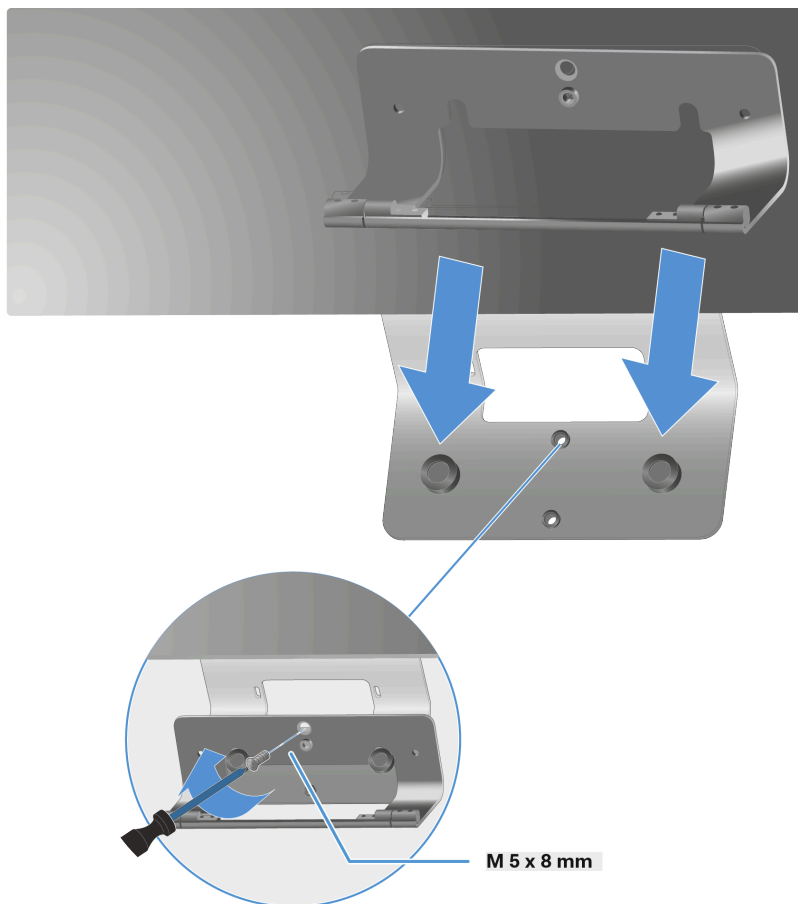

- ▶ Slightly tilt the TC Bar downward and attach the bracket to the VESA mount using an M 5 x 8 mm screw.
- ▶ Position the TC Bar upright again and place it at the appropriate angle.

✓ The TC Bar was successfully mounted on a VESA mount.



## Mounting the accessories bracket

The bracket for the remote control and the lens cap can be placed on a table or mounted on a wall.

Two double-sided adhesive strips and two optional screws are included in the delivery to attach the bracket to a wall.

Both sides of the adhesive strips adhere and can be attached to dry, clean, grease-free, smooth surfaces.

### Attaching the bracket with adhesive strips

- ▶ Remove the lower film from both adhesive strips and attach them to the intended surfaces on the rear side of the bracket.

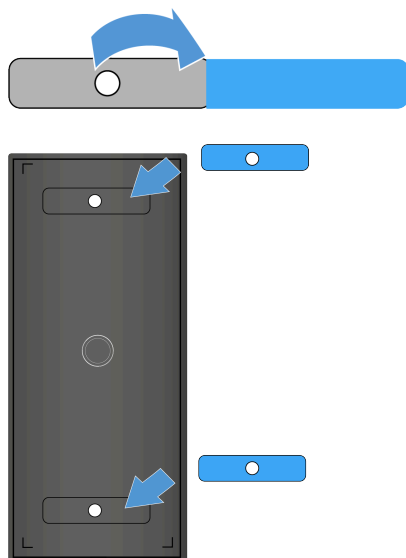

- ▶ Remove the upper films from both of the attached adhesive strips.





- i** Make sure the surface that the bracket is supposed to attach to is mostly dry, smooth, and free of dirt and grease. If necessary, clean the surface before mounting the bracket.

- ▶ Adhere the bracket to the desired surface and hold the bracket pressed firmly in place for 10 seconds.

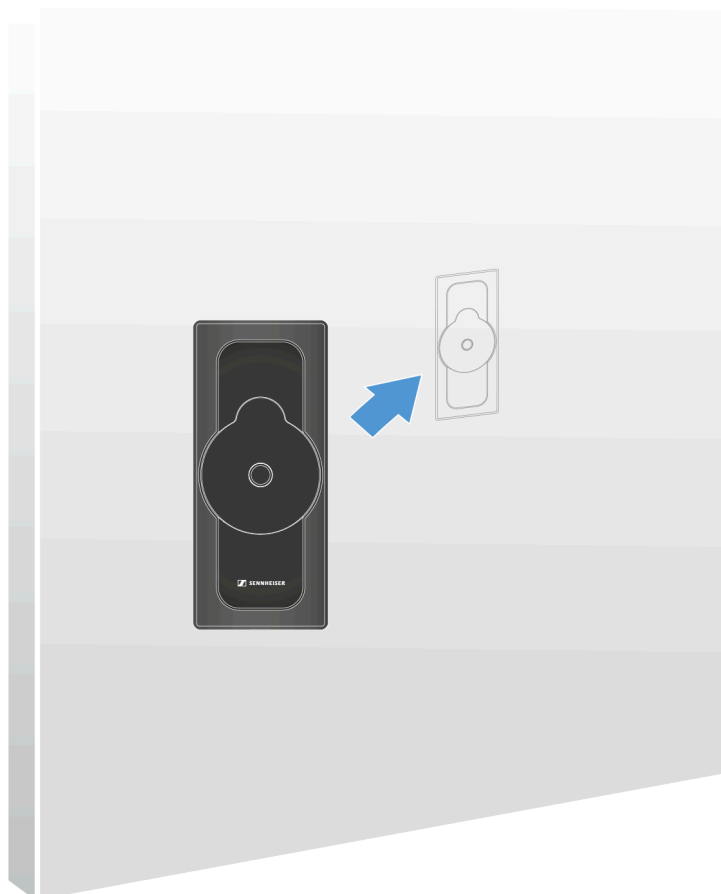

- ✔ The bracket has been attached using the adhesive strips.



### Attaching the bracket with screws

**i** Note the material the wall is made of. Depending on the material it is made of, other screws (than the ones included in the delivery) and dowels (not included in the delivery) may be required.

- ▶ Open the bracket's housing by carefully loosening the appropriate locking point on the bottom of the plate and pulling it upward.

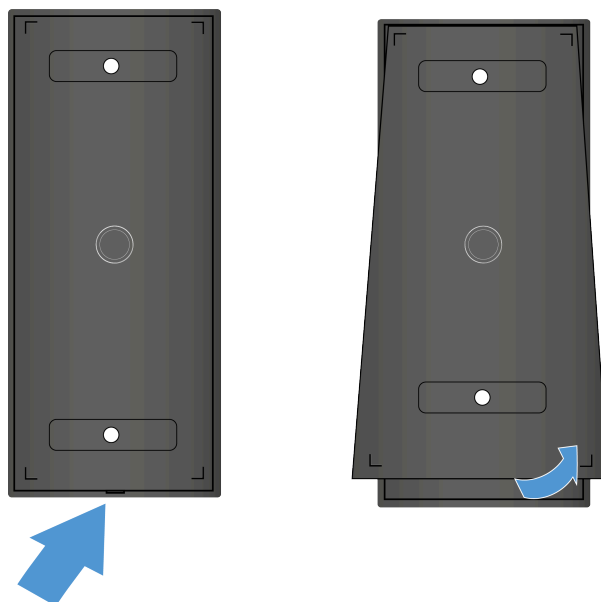

✓ The bottom of the plate loosens.

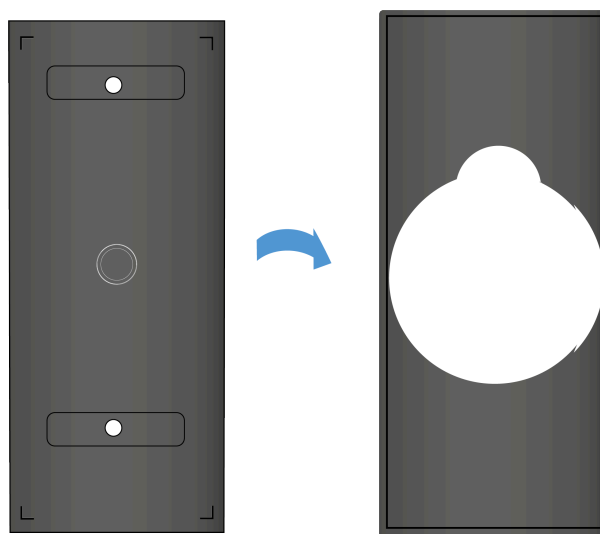

- ▶ Guide the screws included in the delivery through the holes in the plate and tightly screw the bracket to the wall.

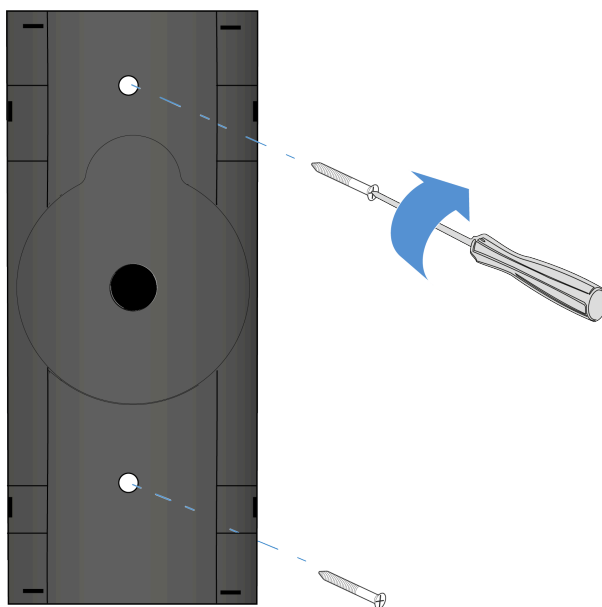

✓ The plate has been attached to the wall.

- ▶ Insert the upper plate into the attached housing. Mind the lower locking point while doing so.

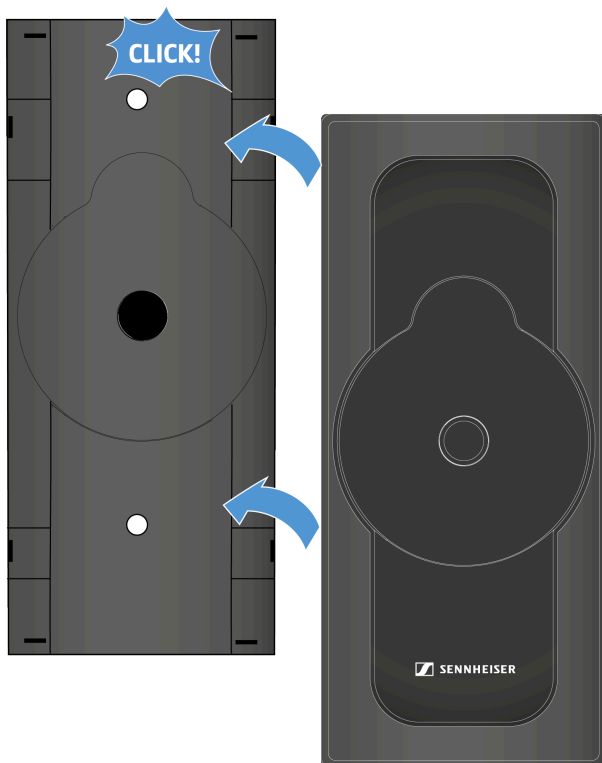



- ✓ The plate and housing lock with a click.

**i** To remove the bracket, first loosen the locking point from the bottom using a flat head screwdriver. Then twist the screws out of the wall.

- ✓ The bracket has been attached to the wall.



## Start-up the product

This chapter describes the initial configuration and commissioning of the TC Bar.

### Preparation

1. Read the safety instructions for the product purchased. The safety instructions are in a separate document in the package.
2. Unpack the TC Bar completely and make sure the delivery includes everything it should (see [Scope of delivery](#)).
3. Remove the protective film attached to the camera lens.
4. Mount the TC Bar according to the possible mounting options (see [Mounting options](#)).
5. Begin the device startup process step by step.

## Preparing the remote control

You can use the remote control to control the different camera modes, activate the Bluetooth® initialization process, and configure various audio settings, such as the volume and muting (see [Product overview - remote control](#)).

### DANGER



#### Danger due to the influence of magnetic fields

Magnets may affect the function of cardiac pacemakers and implanted defibrillators.

- ▶ Always maintain a distance of at least 10 cm/4" between the product and the cardiac pacemaker or implanted defibrillator (ICDs) or other implants, as the product generates permanent magnetic fields.
- ▶ Warn people who have such devices that they are approaching magnets.



**To prepare the remote control for operation:**

- ▶ Open the battery compartment on the bottom of the remote control by pulling the cover approx. 5 mm backward and then upward.



- ▶ Insert the AAA 1.5 V batteries included in the delivery or new ones. Observe the polarity shown when doing so.

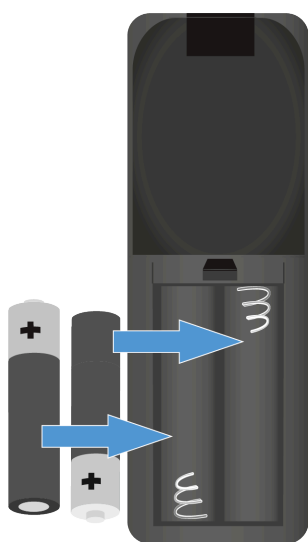

- ▶ Close the battery compartment.
  - ✓ The cover locks into place with an audible click.

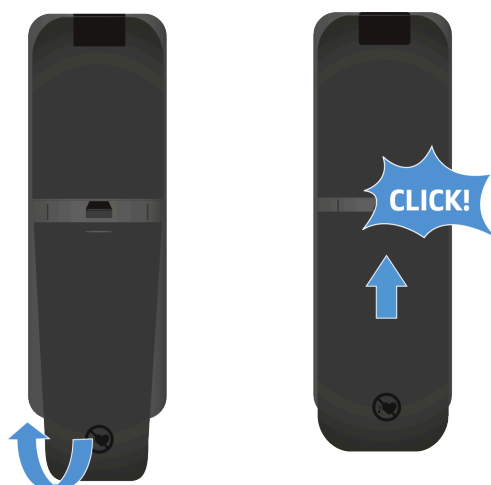

- ▶ Remove the protective film from the infrared transmitter diode of the remote control.

✓ The remote control is now ready for operation.



## Connecting the TC Bar to the power supply system and starting it

When the TC Bar is connected to the power supply system, the device starts automatically.

### To connect the TC Bar to the power supply system:

- ▶ Insert the plug of the DC power supply unit into the **DC IN** socket of the TC Bar and guide the cable through the cable sheath.

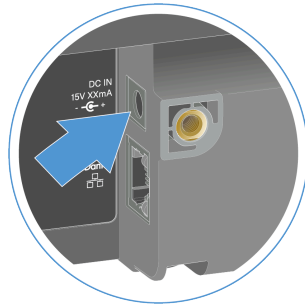

- ▶ Plug the AC power supply unit into the wall socket.  
Optional: You can connect the TC Bar S to the power supply system via PoE+.

**i** The TC Bar S is a power-consuming PoE+ device (powered device) and can be operated using no more than the network cable. For continuous power supply, we recommend always connecting the power supply unit included in the delivery. Use only network cables with the standard CAT5e (F/STP) or better.

- ▶ Plug the RJ45 Ethernet cable into the **PoE+ (PD)** socket of the TC Bar.

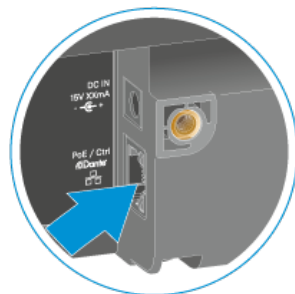

- ✓ The white LED flashes during the boot process. A short melody sounds when the device is ready for operation.

### To completely disconnect the TC Bar from the power supply system:

- ▶ Unplug the power supply unit from the wall socket.
- ▶ Unplug the power supply unit from the DC IN socket of the TC Bar.



- ▶ If the power is supplied only via PoE+, remove the network cable from the device's network port.
  - ✓ The TC Bar has been completely disconnected from the power supply system.

✓ The TC Bar was successfully connected. The device starts automatically.



## Connecting the TC Bar to a device (stand-alone solution)

The TC Bar can be connected to the device to be used (PC/laptop/Mac) and started using a USB-C® connection.

**i** Note the system requirements for the device used (see [System requirements](#)).

### To connect the TC Bar to the device:

- ▶ Plug the USB-C® cable into the USB-C® socket of the TC Bar.

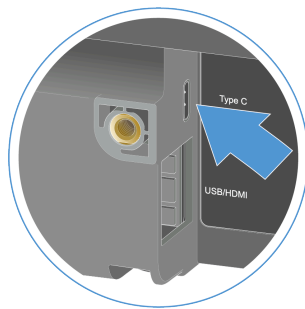

- ▶ Plug the other end of the USB-C® cable into the USB-C® socket of the device to be used.
- ✓ The operating system automatically recognizes and installs the TC Bar. Once the installation has completed successfully, the speakers play a brief sound.

**i** The TC Bar is certified for professional conference applications. Depending on the provider, interactive configuration tips may appear the first time the TC Bar is used.

✓ The TC Bar has been connected to a device.



## Connecting the TC Bar to an external screen (optional)

You can use the TC Bar to transmit provisioned video signals to external screens using an HDMI® connection.

- i** The TC Bar M has two HDMI® outputs that can be configured freely and individually occupied. Please note that the HDMI® output is deactivated in the factory settings. You can activate the HDMI® output in the Sennheiser control application ([Monitoring & Controlling](#)).

### To connect the TC Bar to an external screen:

- ▶ Insert the HDMI® cable included in the delivery into the **HDMI** output connection of the TC Bar.

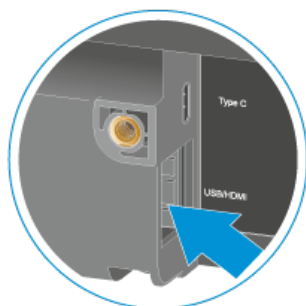

- ▶ Insert the other end of the HDMI® cable into the **HDMI IN** input connection of the external screen.

### To disconnect the TC Bar from an external screen:

- ▶ Pull the HDMI® cable of the **HDMI** connection out of the TC Bar.

✓ The TC Bar has been connected to an external screen.



## Connecting an external PTZ camera

You can connect an external PTZ camera using the USB-A connection.

- i** Please note that you will have a total of two transmission options at your disposal after connecting an external camera. In the conference platform used, please configure the distribution of the video signal or preferred video source.

### To connect an external camera:

- ▶ Insert the USB-A connection of the external camera into the USB-A connection of the TC Bar.

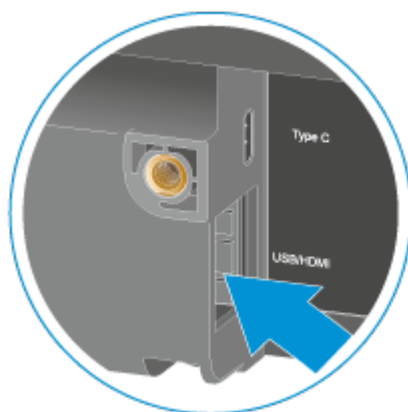

- ✓ The camera is detected automatically.

- ✓ An external camera was connected to the TC Bar.



## Usage

The following chapters contain additional information on operating the TC Bar.

The chapters listed here describe all actions that can be performed in the stand-alone mode of the TC Bar and thus without the use of any control software.

For specific commands from a control software, navigate to the chapters of the corresponding application: [Monitoring & Controlling](#).

Depending on the operating mode, you have either very limited or full options for using the functions of the TC Bar.

### Stand-alone Network



- Connection via USB-C® (see [Connecting the TC Bar to a device \(stand-alone solution\)](#))
- Restricted functions are available only via the remote control (see [Product overview - remote control](#)).
- Configurable via local webUI (see [Running Local Web UI \(LUI\)](#))
- Integrated into the corporate network (see [Operation as a networked conference system](#))
- Configurable via local webUI (see [Running Local Web UI \(LUI\)](#))
- Configurable via central control application (see [Control software](#))

## Safety instructions for high volume levels

Read and observe the following safety instructions for high volume levels before using the product.

### Danger due to high volume levels

- This product is capable of producing sound pressure levels exceeding 85 dB (A). 85 dB (A) is the sound pressure corresponding to the maximum permissible volume which is by law (in some countries) allowed to affect your hearing for the duration of a working day. It is used as a basis according to the specifications of industrial medicine. Higher volumes or longer durations can damage your hearing. At higher volumes, the duration must be shortened in order to prevent hearing damage.



- The following are clear warning signs that you have been subjected to excessive noise for too long:
  - You hear ringing or whistling in your ears.
  - You have the impression (even briefly) of no longer being able to hear high tones.
- Inform all users of these risks and ask them to set the volume to a moderate level, if necessary.



## Starting a web conference

You can start a web conference or dial into an ongoing conference with the TC Bar.

- i** In an audio conference set up via a mobile device (e.g., a smartphone), you can use the TC Bar as a primary audio source for signal input and output (see [Starting an audio conference using a mobile device](#)).

### To start a web conference:

- ▶ Open the conference platform you use and start the planned meeting.
  - ✓ The TC Bar is automatically detected as the primary conference system as long as no additional conference system is already connected.

- i** If the TC Bar is not automatically detected as a primary audio and video system, configure the TC Bar as a primary device in the settings of the conference platform concerned.

- ✓ The web conference starts.



## Starting a call

You can make calls with the TC Bar using the integrated microphones and speakers.

- i** In an audio conference set up via a mobile device (e.g., a smartphone), you can use the TC Bar as a primary audio source for signal input and output (see [Starting an audio conference using a mobile device](#)).

### To start a call:

- ▶ Select the number of the contact person you want to call from the conference system in use.
- ✓ The audio call begins, and the TC Bar is automatically detected as a primary conference system.

- i** If the TC Bar is not automatically detected as a primary audio source, configure the TC Bar as a primary device in the settings of the conference platform concerned.

- ✓ The call starts.



## Starting an audio conference using a mobile device

The TC Bar can be used as a primary audio source in an audio conference set up with a mobile device (e.g., a smartphone).

In an audio conference set up with a mobile device, you can use the TC Bar as the primary microphone and output audio signals through the speakers of the TC Bar. Doing so allows several people in the room to participate directly in the conference that has been set up.

- i** For this type of conference, the TC Bar cannot be connected with either an Ethernet cable or a USB-C cable. Transmission and replay take place only through an active Bluetooth® connection with the device.

### To start an audio conference using a mobile device:

- ▶ Connect the TC Bar with your mobile conference device using Bluetooth® (see [Monitoring & Controlling](#)).
- ▶ Start your audio conference using your mobile device.
- ▶ Select the TC Bar as the primary audio source in the conference platform you use (such as Teams, Zoom, etc.).

- ✓ The TC Bar is used as a primary audio source in an audio conference set up using a mobile device.



## Muting internal TC Bar microphone

Use the remote control or your control application to mute or unmute the internal microphone.

- i** Muting the microphone can also be activated or deactivated using the system settings of the operating system and/or conference system in use (e.g., MS Teams, Zoom, etc.).

### To mute the internal microphone of the TC Bar

- ▶ Briefly push the mute button on the remote control.

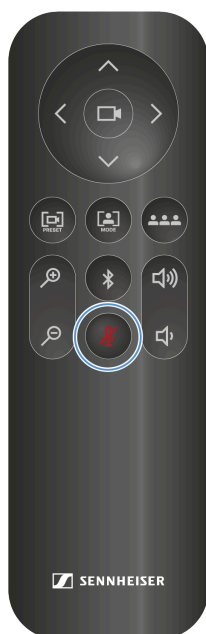

- ✓ The lower LED for audio settings shines red. Muting is activated.

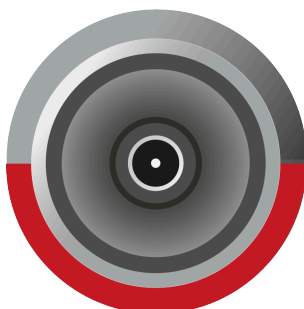



**To stop muting:**

- ▶ Briefly push the mute button on the remote control.
- ✓ The red LED goes out. The audio output is no longer muted.

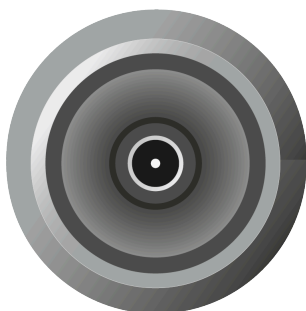

✓ The TC Bar has been muted.



## Setting the volume (remote control)

You can adjust the volume by using the remote control or your control application.

**i** You can also adjust the volume using the system settings of the operating system used, the conference system used (e.g., MS Teams, Zoom, etc.) or the control panel in Sennheiser's control software.

The volume can be adjusted within a range from 0 to 100.

Examples:

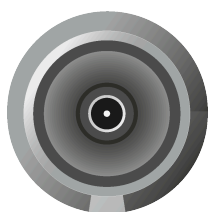

Volume 0

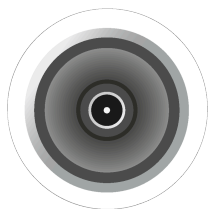

Volume 100

### WARNING



#### Danger due to high volume levels

Volume levels that are too high may damage your hearing.

- ▶ Reduce the volume and the microphone amplification, if applicable, before using the product.

- ▶ Adjust the volume of the speakers to the desired level by doing one of the following:
  - Press the volume buttons on the remote control.
- ✓ The LED indicates the current volume setting.

✓ The volume has been set.



## Setting the camera position

You can use the remote control to set the camera angle and camera zoom. You can also save and call up the camera position.

The following functions can be used to set the camera:

- Zoom the camera in and out
- Tilt the camera down or up
- Pan the camera to the left or right
- Set the camera to standard settings
- Save and call up the camera position

### To zoom the camera in and out:

- ▶ Press the + or - button on the remote control.



- ✓ You will zoom in or out of the image.



**To adjust the camera position:**

**i** Please note that the camera setting is completely zoomed out by default. Before you can change the position manually, the camera must be zoomed in. The camera still must not be activated in a mode (see [Auto framing](#) or [Person tiling](#)).

- ▶ Press the arrow keys on the remote control: **up, down, left, or right**.

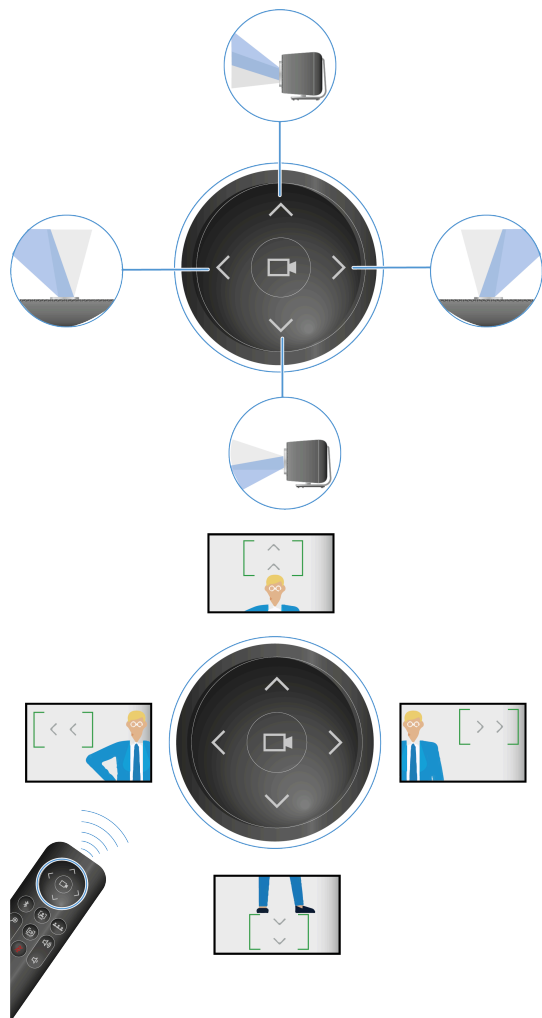

✓ The camera position has been changed.



**To save the camera position:**

- ▶ Press the **Preset** button on the remote control for at least 3 seconds.



- ✓ The camera position has been saved.

- ▶ Briefly press the **Preset** button to move the camera to the saved position.

**To set the camera position to standard settings:**

- ▶ Press the **Full field of view** button on the remote control.



- ✓ The camera position has been set to standard settings.

✓ The camera position has been set.



## Camera settings

The upper half of the LED ring shows the current camera settings.

The camera can be controlled using either the remote control or the web interface of the control application.

The LED display can show the status of four modes of the camera functions that are currently set:

- Camera ON/OFF
- Auto framing ON/OFF
- Person tiling ON/OFF

### Auto framing

The **auto framing** function continually focuses on participants in the room, even if they reposition themselves in the room.

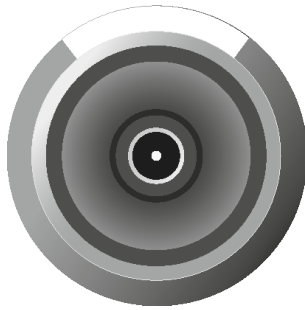

When the function is activated, the lens angle adapts based on the number of people identified in the room and activates continual focus on these people. After that, the camera follows each repositioning of the people in the room, enlarges or reduces the lens angle, and refocuses based on the new circumstances in the room.

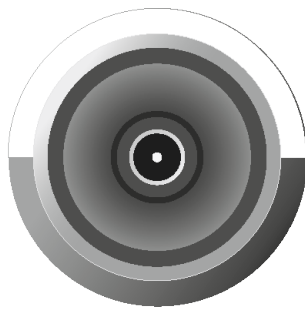

The function is deactivated if the button is pressed again. The camera no longer follows movement in the room.

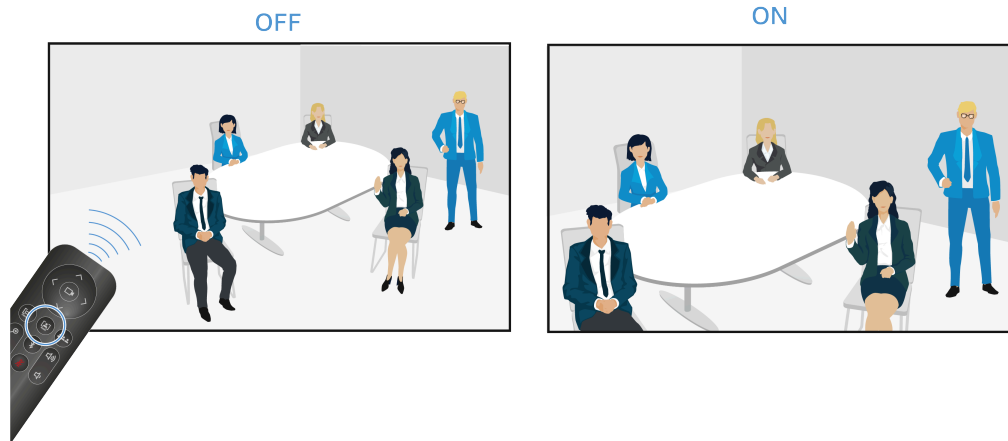

### Person tiling

The **person tiling** function portrays the participants in a manner that is suitable for the far end during a conference. Depending on the number of people in the room, either an overall picture is generated, or each person is shown enlarged in an individual frame.

- i** Grouping: If several people are seated close to one another in a room, they are portrayed as a group and shown in one tile. Please note that the function for simultaneous detection of people in the room is limited to a maximum number of 10.

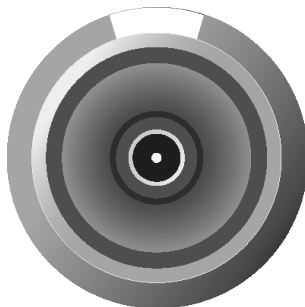

When the function is activated, the lens opens at a large angle with a complete radius of 115°. The first time the button on the remote control is pressed, a complete, wide-angle image is replayed.

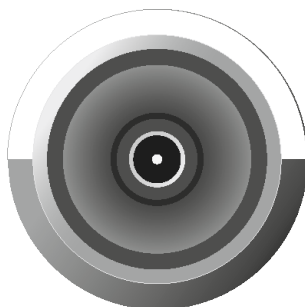

If the button is pressed again, the people recorded are automatically divided into individually tailored frames, and their sections are enlarged. If too many people are present in the room, a custom overall picture is created instead of individual frames.

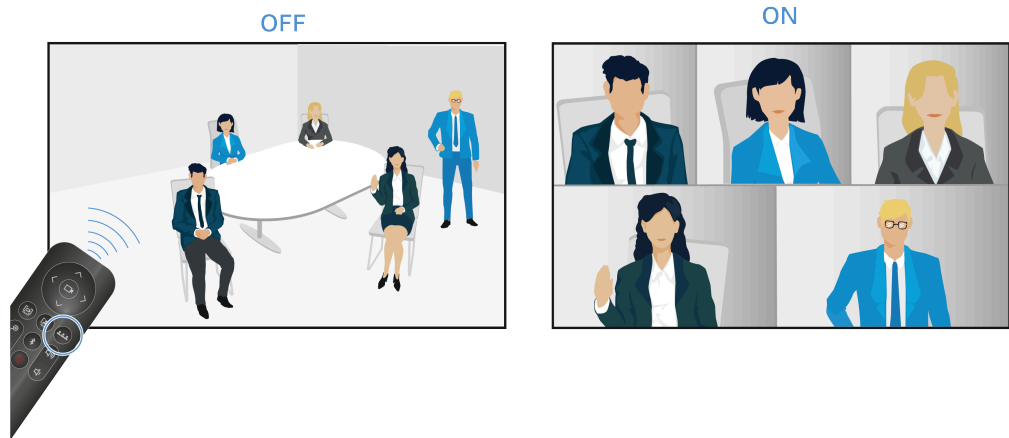



## Pairing the TC Bar with a Bluetooth® device

You can pair the TC Bar with a device that is capable of Bluetooth® to input and output audio signals from the paired device.

- i** Make sure that the Bluetooth® pairing process has been started (see [Starting Bluetooth® pairing](#)).

Via a coupled Bluetooth® connection with the TC Bar, smart devices (such as laptops, smartphones and tablets) can be used to forward microphone signals to the TC Bar and/or output audio signals via the device's speakers.

### To pair the TC Bar with a Bluetooth® device:

- i** Please make sure the distance to the Bluetooth device does not exceed 10 m.

- ▶ Activate Bluetooth on the Bluetooth device you want to pair.
- ▶ In your Bluetooth® environment, look for the product designation “TC Bar S” or “TC Bar M” and click **Pairing**.
- ✓ A short confirmation tone sounds. The Bluetooth® LED on the device remains blue.



- ✓ The TC Bar is paired with your Bluetooth® device.

You can now perform the following actions using Bluetooth®:

- Use a mobile device (e.g., smartphone) as a microphone in a conference room.
- Output audio sound (e.g., music) from a mobile device using the TC Bar.



## Monitoring & Controlling

The TC Bar provides comprehensive monitoring and control functions that enable users to efficiently manage audio and video settings across various applications and interfaces.

The TC Bar can be operated via several applications:

- **DeviceHub**: a cloud-based solution, independent of the user's location (see [DeviceHub](#))
- **Local Web UI**: an embedded local control interface included in the device firmware (see [Local Web UI \(LUI\)](#))
- **Control Cockpit**: a client-based solution for the PC (see [Control Cockpit](#))

### Local Web UI (LUI)

#### Overview

LUI provides a user-friendly platform for interacting with system functionalities and features.

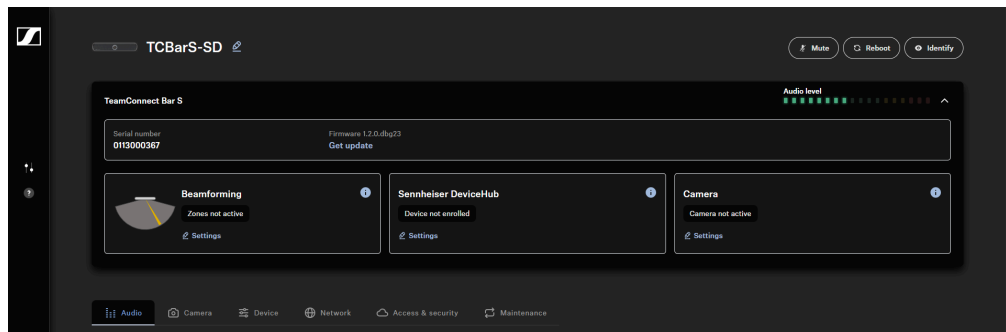

With LUI, you can perform the following actions on the TC Bar:

#### Initial configuration

- [Security information](#)
- [Running Local Web UI \(LUI\)](#)
- [Selecting a sound profile](#)
- [Stipulating a device profile for the camera](#)
- [Selecting a network mode](#)

#### Audio

- [Audio Setup](#)
- [Beam configuration](#)
- [Monitoring & operation](#)



## Camera

- [Creating a user-defined device profile](#)
- [Activating the functions for remote control](#)
- [Enabling auto framing](#)
- [Enabling person tiling](#)
- [Setting default camera mode](#)

## Device

- [Updating the firmware](#)
- [Setting LED brightness](#)
- [Stipulating a device profile for the camera](#)
- [De-/activating sound prompts](#)
- [Rebooting the TC Bar](#)
- [Activating the HDMI® output](#)
- [Changing energy-saving mode](#)

## Network

- [Activating tagged VLAN \(Dante® network\)](#)
- [Activating Bluetooth®](#)
- [Starting Bluetooth® pairing](#)
- [Activating Dante® signal forwarding](#)
- [Activating the continuous Dante® stream](#)
- [Selecting a network mode](#)

## Access & Security

- [Activating third-party access](#)
- [Activating device access](#)

## Maintenance

- [Resetting the audio settings](#)
- [Resetting camera settings](#)
- [Resetting the TC Bar to factory settings](#)



## Initial configuration

This section guides you step by step through the initial configuration using tried-and-trusted methods and procedures.

Additional settings allow you to adapt the TC Bar to the requirements of your existing infrastructure.

**To begin with, we recommend following these steps for the first start:**

- [Running Local Web UI \(LUI\)](#)
- [Selecting a sound profile](#)
- [Stipulating a device profile for the camera](#)
- [Selecting a network mode](#)

**We then recommend configuring the following enhanced settings in LUI as needed:**

- [Activating Dante® signal forwarding](#)
- [Activating tagged VLAN \(Dante® network\)](#)
- [Handling auto mix priority](#)
- [Setting the internal microphone noise gate](#)
- [Adapting far end output for TCC M](#)
- [Creating a priority zone](#)
- [Configuring exclusion zones](#)

## Security information

Local Web UI uses HTTPS, but your browser may show a warning because the device uses a self-signed certificate.

The Local Web UI uses HTTPS to encrypt communication between your computer and the device.

When an HTTPS connection is established, the browser checks the security certificate presented by the website. Local network devices such as Sennheiser AV devices cannot obtain and maintain publicly trusted certificates, so they use a self-signed certificate for encrypted communication. This is common in local network environments where devices provide encrypted web-based management interfaces.

Because the browser cannot verify these certificates automatically, a security warning may appear when you access the Local Web UI. The warning depends on the browser you use.

Examples:

- **Google Chrome:** "Your connection is not private"
- **Microsoft Edge:** "Your connection isn't private"
- **Mozilla Firefox:** "Unable to connect"
- **Safari:** "This Connection Is Not Private"



### Your connection is not private

Attackers might be trying to steal your information from **192.168.178.60** (for example, passwords, messages or credit cards). [Learn more about this warning](#)

NET:ERR\_CERT\_AUTHORITY\_INVALID

 [Turn on enhanced protection](#) to get Chrome's highest level of security

Hide advanced

Back to safety

This server could not prove that it is **192.168.178.60**; its security certificate is not trusted by your computer's operating system. This may be caused by a misconfiguration or an attacker intercepting your connection.

[Proceed to 192.168.178.60 \(unsafe\)](#)

The warning does not mean that communication is unencrypted. Communication between your browser and the Local Web UI is still encrypted using HTTPS, and data transmitted between the browser and the device is protected against passive interception. However, the browser cannot independently confirm that the device is the intended device.

**i** If you access the device on your local network and have intentionally opened the Local Web UI, you can continue through the browser warning.

#### Google Chrome:

- ▶ Click **Advanced** > **Proceed to {IP address} (unsafe)**.

#### Microsoft Edge:

- ▶ Click **Advanced** > **Continue to {IP address} (unsafe)**.

#### Mozilla Firefox:

- ▶ In the permission dialog displayed by your operating system, click **Allow**.
- ▶ Click **Advanced** > **Proceed to {IP address} (Risky)**.

#### Safari:

- ▶ Click **Show Details** > **Visit this website**.
- ▶ Confirm the permission dialog displayed by your operating system.



After you accept the warning, the Local Web UI opens normally.



## Running Local Web UI (LUI)

Connect and configure your device via the embedded Local Web UI.

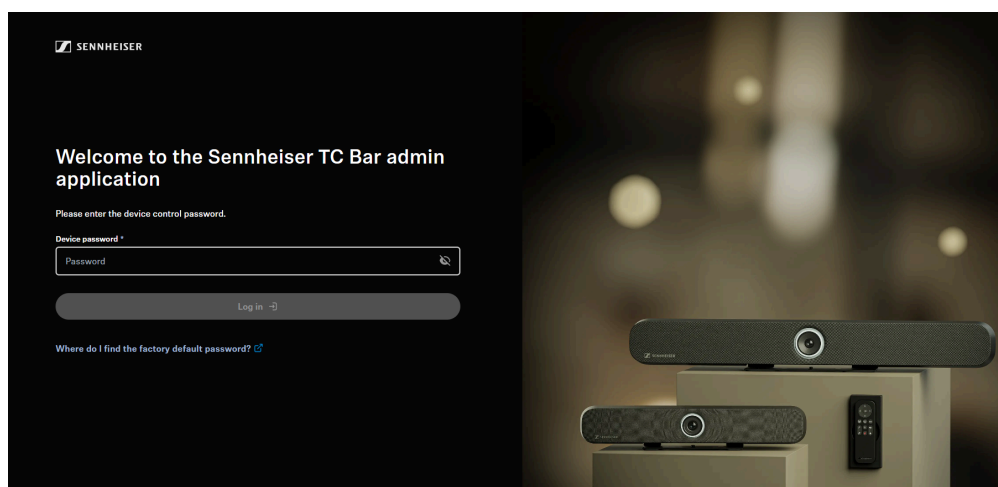

To run the Local Web UI, perform the following steps:

1. Connect the device (e. g. TC Bar) to your network.
2. Determine the assigned IP address or hostname of the device.
3. Access the device in the browser using the IP address and initialize the device upon first use.

### To access the Local Web UI:

- ▶ In your browser, navigate to the device's IP address or hostname using "https", e.g.: `https://IP-address` .

**i** Your browser may display a security warning, although communication between your browser and the Local Web UI is still encrypted using HTTPS. For details, see [Security information](#).

- ▶ Depending on your browser, do the following steps:
  - Google Chrome:
    - ▶ Click **Advanced** > **Proceed to {IP address} (unsafe)**.
  - Microsoft Edge:
    - ▶ Click **Advanced** > **Continue to {IP address} (unsafe)**.
  - Mozilla Firefox:
    - ▶ In the permission dialog displayed by your operating system, click **Allow**.
    - ▶ Click **Advanced** > **Proceed to {IP address} (Risky)**.



- Safari:
  - ▶ Click **Show Details** > **Visit this website**.
  - ▶ Confirm the permission dialog displayed by your operating system.
- or similar (other browsers)
- ✔ You now have access to the Local Web UI.

**To initialize the device upon first start:**

- ▶ Type in the password set in the factory state, which can be found on the back of the product label under **Default password**.

**i** If the device was previously initialized by another device management solution like Sennheiser Control Cockpit, the previously set password must be entered. If you cannot remember the previously set password, please check the existing configuration setup or perform a [factory reset](#) of the device.

- ▶ If this device was not configured beforehand, you will be asked to set a new device password. Please enter a new device password for future configuration.

**i** Please note that the new password must meet the following requirements:

- At least ten characters
- At least one lowercase letter
- At least one uppercase letter
- At least one number
- At least one special character: !#\$%&()\*+,-./:;<=>?@[^\_{}~
- Maximum length: 64 characters

✔ You have successfully logged into the Local Web UI.



## Selecting a sound profile

Sound profiles are presets that are optimized for the intended mounting options.

You can either select a profile (recommended) or manually adjust the equalizer setting.

- ▶ In , navigate to **Audio > Audio Setup**.
- ▶ Select the installed mounting type from the drop-down list (recommended).  
**Optional:** Select **Custom** to configure your own settings.

✓ The sound profile for your TC Bar has been selected.



## Stipulating a device profile for the camera

Device profiles contain custom or predefined settings for supported conference and collaboration platforms.

- **Custom:** Activates all the settings on the **Camera** tab and the HDMI® output on the **Device** tab.
- **Microsoft Teams:**
  - Activates the standard settings for Microsoft Teams.
  - Resets all settings on the **Camera** tab.
  - Deactivates the HDMI® output on the **Device** tab.
  - Restarts the device.

**i** This profile reduces the camera zoom of the TC Bar in order to fulfill the specifications of Microsoft Teams.

- **Zoom**
  - Activates the standard settings for Zoom.
  - Resets all settings on the **Camera** tab.
  - Restarts the device.

**i** This profile reduces the camera zoom of the TC Bar in order to fulfill the specifications of Zoom.

### To select the device profile for the camera:

**i** When the device profile is changed, the camera settings are reset, and the device is rebooted.

- ▶ In , navigate to **Camera**.
- ▶ Select the desired profile under **Device Profiles**.

✓ The device profile for the camera has been defined.



## Selecting a network mode

You can configure the various network modes using the panel in Sennheiser's control software.

**The TC Bars are in the following network modes in the factory settings:**

- TC Bar S: Single domain mode
- TC Bar M: Split mode

**To select a network mode:**

- ▶ In , navigate to **Network**.
- ▶ Select a network mode from among the following options:
  - Single domain mode
  - Dual domain mode
  - Split mode (only for TC Bar M)

✓ The network mode has been selected.



## Audio

The following settings can be managed via the audio tab.

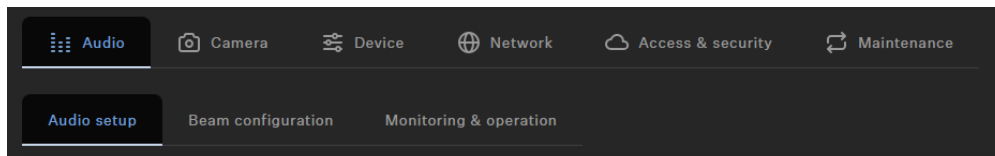

The Audio tab is divided into following sections:

- [Audio Setup](#)
- [Beam configuration](#)
- [Monitoring & operation](#)

## Audio Setup

The following settings can be managed via the audio setup section.

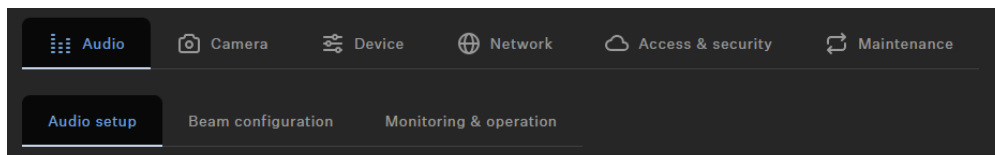

## Sound Profile

Sound profiles are presets that are optimized for the intended mounting options.

Custom: 7-band equalizer for manually adjusting or selecting preset sound settings depending on the mounting option of the device:

- Wallmount
- Table Top
- Under Display
- Above Display
- Free Standing
- Custom

## Internal Microphone Noise Gate

### Noise Gate:

Noise Gate can be activated to avoid amplification of background noise, e.g. during pauses in speech.

### Threshold:

The Noise Gate will open the audio of the microphone output only after the predefined threshold value of the needed microphone has been reached. With the slider you can adjust the minimum threshold level from -70 dB to -30 dB in steps of 1 dB.



### Hold Time:

The Hold Time sets the duration until the noise gate is activated, e.g. during speech pauses. With the slider you can adjust the duration time from 100 ms to 500 ms in steps of 50 ms.

### Range

The 'Range' parameter defines the degree of noise suppression below the set threshold for the entire Noise Gate. The parameter can be set in steps of 1 dB between 0 dB (no suppression) and 80 dB (the level is reduced by 80 dB below the threshold and after the 'attack time').

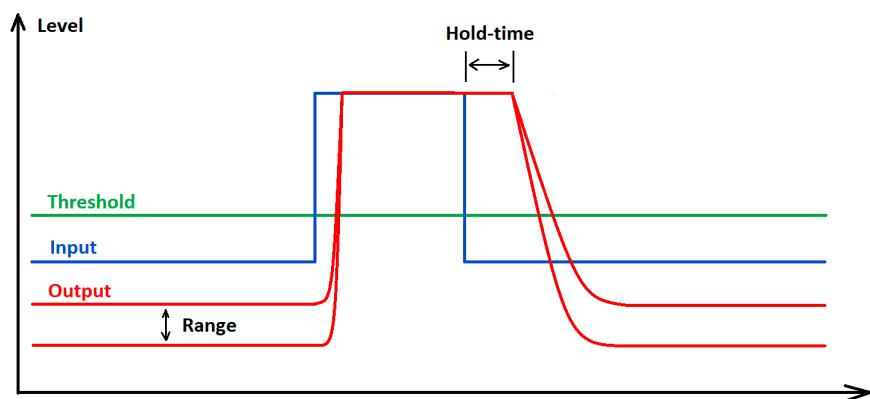

### Automix Priority

The TC Bar has up to two Dante® inputs for external microphone channels (Ext. CH 1 and Ext. CH 2). The channels allow external devices (e.g. TeamConnect Ceiling Medium) to be connected to the TC Bar via a Dante® network. The settings via the Automix Priority only manage the priority of the selected channel. It has no influence on the actual gain level of the connected microphones.

### Integrated Automixer

The Dante® inputs are managed via an integrated automixer, whereby the priority of the channels, including the internal microphone array, can be set via individual faders. Reducing the level by the corresponding control fader will add a virtual level reduction to the channel that makes it less likely to be selected by the automixer.

### Level meters

The level meters show the signal level of the inputs and the internal microphone array PRE fader and also PRE virtual level reduction. Moving the faders therefore does not change the displayed levels.

### Prioritizing a single channel

If you want to prioritize a single channel from the selection, you will have to reduce the virtual gain reduction of the other two channels. With Fade Time you can adjust the switching speed between the audio sources connected to the auto mixer.



### Active channel

The automixer provides an indicator above the channels to show the active channel. If the channel is active, the indicator changes to green. The automixer has a NOM (Number of Open Microphones) = 1, so that only one microphone can be active at a time.

### Conference Output

Controls the level of the near and far end signals at the Dante® conference output.

Slider for adjusting the digital audio output level from 0 dB to -60 dB in steps of 1 dB.

### Selecting a sound profile

Sound profiles are presets that are optimized for the intended mounting options.

You can either select a profile (recommended) or manually adjust the equalizer setting.

- ▶ In , navigate to **Audio > Audio Setup**.
- ▶ Select the installed mounting type from the drop-down list (recommended).  
**Optional:** Select **Custom** to configure your own settings.

✓ The sound profile for your TC Bar has been selected.



## Setting the internal microphone noise gate

The noise gate ensures background noises are not intensified during pauses in speech.

In principle, the internal noise suppression function is able to effectively reduce noise from the room. However, there can be instances when an additional noise gate is required. The noise gate ensures background noises are not intensified during pauses in speech. This is especially important when several microphones are used simultaneously.

During speech pauses, for instance, the system automatically increases amplification owing to the assumption that insufficient signal strength is present. This causes the background noises to be amplified unnecessarily.

### Threshold

You can stipulate a **threshold value** as of which the system mutes the microphone. The noise gate does not open the audio output of the microphone until the microphone used exceeds the stipulated threshold value. With the slider, you can adjust the minimum threshold value from -70 dB to -30 dB in increments of 1 dB.

### Hold time

The **hold time** determines how quickly the microphone reduces the amplification. A delay of up to 500 ms can be set. You can set the hold time from 100 ms to 500 ms in increments of 50 ms.

#### To set the noise gate threshold value:

- ▶ In , navigate to **Audio > Audio Setup**.
- ▶ Activate the function **Noise Gate** in the field **Internal Microphone Noise Gate**.
- ▶ Set the desired value under **Threshold**.
  - ✔ The threshold value has been set.

#### To set the hold time:

- ▶ In , navigate to **Audio > Audio Setup**.
- ▶ Activate the function **Noise Gate** in the field **Internal Microphone Noise Gate**.
- ▶ Set the desired value under **Hold Time**.
  - ✔ The hold time has been set.

✔ The internal microphone noise gate has been set.



## Handling auto mix priority

You can use the auto mix priority to set the priority of the channels, including the internal microphone arrays, via individual controllers.

The TC Bar has up to two Dante® inputs for external microphone channels (ext. CH 1 and ext. CH 2). The channels make it possible to connect external devices (e.g., TeamConnect Ceiling Medium, etc.) to the TC Bar via a Dante® network. The Dante® inputs are managed using an integrated auto mixer, whereby the priority of the channels, including the internal microphone array, can be configured using individual faders.

**i** The settings for the auto mix priority manage only the priority of the selected channel. They have no effect on the actual amplification level of the connected microphones.

When the level is decreased using the corresponding controller, a virtual level reduction is added to the channel. This makes the auto mixer less likely to select the channel. Moving the controllers does not change anything about the levels displayed.

If you want to favor an individual channel from the selection, reduce the virtual amplification of the other two channels. The lower the dB number, the more likely the channel is to be selected.

Example:

Int. mic.	Ext. CH 1	Ext. CH 2	Explanation
-30 dB	-60 dB	0 dB	<ul style="list-style-type: none"><li>• Ext. CH 2 has the highest priority and is thus selected most often.</li><li>• Int. mic. has a lower priority and is thus selected less often.</li><li>• Ext. CH 1 has the lowest priority.</li></ul>
-60 dB	-10 dB	-30 dB	<ul style="list-style-type: none"><li>• Ext. CH 1 has the highest priority and is thus normally selected.</li><li>• Ext. CH 2 has a lower priority and is thus selected less often.</li><li>• Int. mic. has the lowest priority.</li></ul>
0 dB	-30 dB	-30 dB	<ul style="list-style-type: none"><li>• Int. mic. has the highest priority and is thus normally selected.</li><li>• Ext. CH 1 and 2 have a lower priority and are thus selected less often.</li></ul>



## Configuring fade time

You can use the fade time to configure the speed at which the devices switches between the audio sources connected to the auto mixer.

- ▶ In , navigate to **Audio > Audio Setup**.
- ▶ Start by reducing the int. mic. by -30 dB.
- ▶ Speak in various positions and listen to whether the sound meets your expectations on the other end of a telephone conference.
- ▶ Select different values for the fade time and listen to the transition from one microphone to another.

✓ The fade time has been configured.



## Adapting far end output for TCC M

You can adapt the amplification of the TCC M signal with far end output.

The standard settings in TCC M are tailored to common application cases. In certain scenarios, you can use the following settings on the Audio tab to finely adjust the output.

### To adapt the amplification in the Far End Output (digital) field of the TCC M:

- ▶ In the Control Cockpit, navigate to **Devices > TCC M > Audio**.
- ▶ Increase the amplification in the field **Far End Output (digital)** if the TCC M is very far from the audience.
- ▶ Decrease the amplification if the TCC M is very close to the audience.

### To configure the sensitivity of the beam freeze:

- ▶ In the Control Cockpit, navigate to **Devices > TCC M > Audio**.
- ▶ Increase the input level under **Manual gain** to activate the beam freeze earlier and thus achieve better echo suppression.
- ▶ Decrease the input level to improve the near end and double talk.
- ▶ Select **Automatic gain** if the seating in a room changes often, for example. Doing so allows the TCC M microphone to adjust itself to the best input level.

✓ The far end output was adjusted.



## Muting internal TC Bar microphone

Use the remote control or your control software to mute or unmute the internal microphone.

- i** Muting the microphone can also be activated or deactivated using the system settings of the operating system and/or conference system in use (e.g., MS Teams, Zoom, etc.).

### Muting the TC Bar

- ▶ To mute the internal microphone of the TC Bar
  - Briefly push the mute button on the remote control or

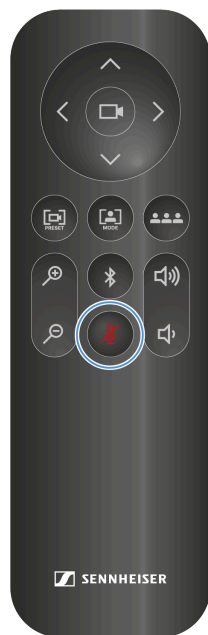

- In , navigate to **Audio > Audio Setup** and deactivate the setting **Internal Mic Mute**.

- ✓ The lower LED for audio settings shines red. Muting is activated.

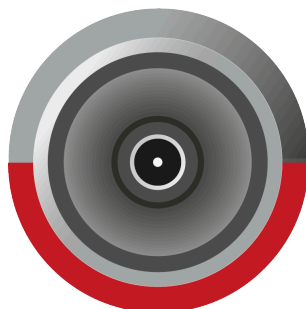



**Stop muting:**

- ▶ Stop the muting by doing the following:
  - Briefly push the mute button on the remote control or
  - In , navigate to **Audio > Audio Setup** and deactivate the setting **Internal Mic Mute**.
- ✓ The red LED goes out. The audio output is no longer muted.

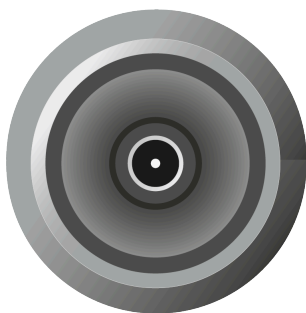

✓ The TC Bar has been muted.



## Muting all microphones

Mute all input channels with a single click.

**i** This function mutes all microphone input channels:

- Internal microphone
- External CH1
- External CH2

### To mute all input channels:

- ▶ In , navigate to **Audio > Audio Setup**.
- ▶ Enable the slider labeled **All Microphones Mute**.
  - ✓ The lower LED for audio settings lights red, indicating muting is active.

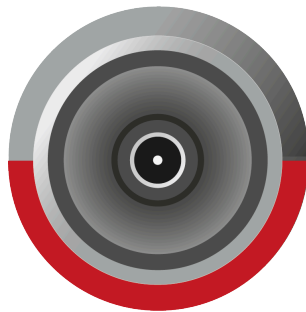

✓ All input mic channels have been muted.



## Enabling Dante® speaker output

Route audio to external Dante® speakers and disable the device's internal speakers.

When enabled, audio output is routed to external Dante® speakers and the device's internal speakers are muted.

- i** Before enabling this function, ensure that the Dante® protocols are enabled (see [Activating Dante® signal forwarding](#)). Also verify that routing has been configured in Audinate Apps before activation; otherwise, echo effects may occur.

### To enable the Dante® speaker output:

- ▶ In , navigate to **Audio > Audio Setup**.
- ▶ Activate the slider in the field **External Dante® speaker output**.

✓ Audio output is routed to the external Dante® speakers.



## Activating location-based mute

You can mute several devices in a room at the same time by using the mute switch on any transmitter.

In order to do so, you must add the device to the mute group for the location.

The following functions are available:

### Deactivated

The TC Bar is not part of a mute group. Muting or unmuting does not affect other transmitters.

### Part of group

Activate this function to add the TC Bar to a mute group. If one of the transmitters in this mute group is subsequently muted, all other transmitters in the same mute group at the same location will be muted or unmuted at the same time. This is how you can create your own mute group for each location.

**i** If you use the regular mute function via the TC Bar with a routed TCC M, we recommend setting the LED brightness of the **TCC M** to **0**. The mute function can be displayed only on the TC Bar, not on the TCC M.

## CAUTION



### Danger due to high volume levels

If the TCC M is routed, undesired echoes may occur if **Location-based Mute** is used during a conference. During muting, the microphone input current is paused, and, accordingly, the AEC cannot always assess the impulse response from the far end.

- ▶ Avoid using this function in combination with a routed TCC M.
- ▶ If you use the function, reduce the volume and, if applicable, the microphone amplification before reactivating this function.

To activate the location-based mute function:

- ▶ In , navigate to **Audio > Audio Setup**.
- ▶ Activate the function **Location-based Mute**.
  - ✓ The display switches to **Part of group**.

✓ Location-based mute has been activated.



## Beam configuration

The following settings can be managed via the beam configuration section.

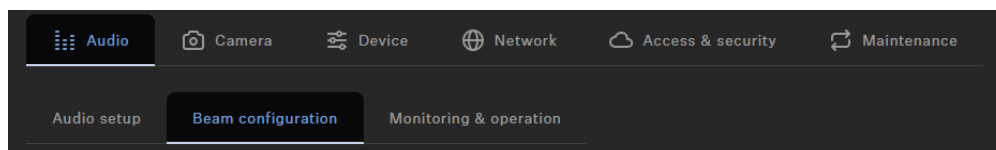

The TeamConnect Bar allows you to define two different types of zones:

- One Priority Zone - Zone to be preferred
- Up to three Exclusion Zones - Zones to be excluded

For each zone the horizontal angles can be set individually.

### Priority Zone

**i** In case both zone types overlap, the rules of the Exclusion Zone will apply.

The Priority Zone allows you to set up a zone which will be handled prioritized in case of incoming audio signals from different positions at the same time. This feature can be useful e.g. during conference meetings with an important person involved.

You can adjust a weighting for this zone. The weighting increases the focus on the incoming signals from the zone by the selected values. The following settings can be made:

- **Mid:** Increases the weighting on the audio output from the zone by about 1.5 times the normal value.
- **High:** Increases the weighting on the audio output from the zone by about 2.5 times the normal value.
- **Max:** Increases the weighting on the audio output from the zone by about 4 times the normal value.

**i** When defining the Priority Zone the area to be prioritized in the detection of the audio source is indicated green.

You can adjust the slider to set a Priority Zone. The zone can be adjusted individually from 15° to 165°. Minimum size for the angle: 15°.

### Exclusion Zones

**i** In case both zone types overlap, the rules of the Exclusion Zone will apply.



The TC Bar allows you to define up to three exclusion zones. By activating these zones all outgoing audio signals from these areas will be neglected.

**i** When defining the Exclusion Zones the area to be excluded in the detection of the audio source is indicated petrol.

You can adjust the sliders to set the exclusion zone. The horizontal zone can be adjusted individually from 15° to 165°.

### Overview

When you activate the zones, a 2D overview is created on the right, which displays all activated zones in real time. The zones in the 2D model are indicated either green (prioritized) or petrol (excluded).

### Beam configuration

The following settings can be managed via the beam configuration section.

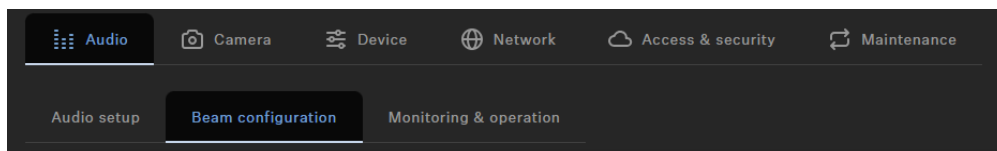

The TeamConnect Bar allows you to define two different types of zones:

- One Priority Zone - Zone to be preferred
- Up to three Exclusion Zones - Zones to be excluded

For each zone the horizontal angles can be set individually.

### Priority Zone

**i** In case both zone types overlap, the rules of the Exclusion Zone will apply.

The Priority Zone allows you to set up a zone which will be handled prioritized in case of incoming audio signals from different positions at the same time. This feature can be useful e.g. during conference meetings with an important person involved.



You can adjust a weighting for this zone. The weighting increases the focus on the incoming signals from the zone by the selected values. The following settings can be made:

- **Mid:** Increases the weighting on the audio output from the zone by about 1.5 times the normal value.
- **High:** Increases the weighting on the audio output from the zone by about 2.5 times the normal value.
- **Max:** Increases the weighting on the audio output from the zone by about 4 times the normal value.

**i** When defining the Priority Zone the area to be prioritized in the detection of the audio source is indicated green.

You can adjust the slider to set a Priority Zone. The zone can be adjusted individually from 15° to 165°. Minimum size for the angle: 15°.

### Exclusion Zones

**i** In case both zone types overlap, the rules of the Exclusion Zone will apply.

The TC Bar allows you to define up to three exclusion zones. By activating these zones all outgoing audio signals from these areas will be neglected.

**i** When defining the Exclusion Zones the area to be excluded in the detection of the audio source is indicated petrol.

You can adjust the sliders to set the exclusion zone. The horizontal zone can be adjusted individually from 15° to 165°.

### Overview

When you activate the zones, a 2D overview is created on the right, which displays all activated zones in real time. The zones in the 2D model are indicated either green (prioritized) or petrol (excluded).



## Overview

The zones overview displays all activated zones in an overall display.

If you activate the zones, a 2D overview is created on the right-hand side and displays all the activated zones in real time. The zones in the 2D model are marked either green (prioritized) or petrol blue (excluded).

**i** If both zone types overlap, the rules of the exclusion zone apply.



## Creating a priority zone

You can use a priority zone to prioritize an important audio area in a room (such as the position of a speaker).

During lively discussions in meetings, the moderator must be able to retain control of the conversation. You can create a priority zone so that voices have priority for reasons besides volume alone. The moderator is always preferred in the incoming signal, even if their voice is quieter. That ensures that the person responsible always has control of the situation regarding voices as well.

You can also configure weighting for the priority zone. The weighting determines how intensively the beam concentrates on this area. You have the following options:

### Mid

- Increases the weighting of the audio signals in the priority zone to approximately 1.5 times the normal audio output (e.g., in rooms with normal ambient noise). Thus, the source outside the priority zone must be 2 dB louder than a source within the priority zone to cause the beam to focus on the source outside the zone.

### High

- Increases the weighting of the audio signals in the priority zone to approximately 2.5 times the normal audio output (e.g., in rooms with high ambient noise). Thus, the source outside the priority zone must be 4 dB louder than a source within the priority zone to cause the beam to focus on the source outside the zone.

### Max

- Increases the weighting of the audio signals in the priority zone to approximately 4 times the normal audio output (e.g., in rooms with strong ambient noise and a quiet moderator). Thus, the source outside the priority zone must be 6 dB louder than a source within the priority zone to cause the beam to focus on the source outside the zone.

**i** If the priority zone overlaps the exclusion zones, the settings for the exclusion zones apply.

### To configure a priority zone:

- ▶ In , navigate to **Audio > Beam Configuration**.
- ▶ Under **Priority Zone**, click the button **Off** to activate the zone.
  - ✓ The switch then changes to the mode **On**.
- ▶ Click **Edit**.



- ▶ Configure the desired priority zone manually in the specified radius.
- ▶ Click **Apply** to save the settings.
  - ✓ The priority zone has been set.

**To set the weighting of the priority zone:**

- ▶ Under **Priority Zone > Weight**, select the desired setting from among the values **Mid**, **High** or **Max**.
  - ✓ The weighting has been set.

✓ The priority zone has been configured.



## Configuring exclusion zones

You can use exclusion zones to exclude unwanted areas from audio recording.

Air conditioners, side doors, loud coffee machines, and adjoining rooms can produce undesired noises. Speakers with audio signals from distant participants can also be a source of disruption for the microphone.

To exclude these undesired background noises, you can define exclusion zones in which the beam tracking function ignores audio signals.

You can configure up to three exclusion zones and activate them at the same time. As soon as the device is initialized, the TC Bar uses a real-time algorithm to detect sources of noise that are then visualized directly as a 2D model. That allows you to quickly and easily localize the source of disruption and define a precise exclusion zone for this area.

### To configure one or more exclusion zones:

- ▶ In , navigate to **Audio > Beam Configuration**.
- ▶ Under **Exclusion zones**, click the button **Off** for the desired zone from 1 to 3 to activate the exclusion zone.
  - ✓ The switch then changes to the mode **On**.
- ▶ Click **Edit**.
- ▶ Configure the desired exclusion zone manually in the specified radius.
- ▶ Click **Apply** to save the settings.

✓ The exclusion zones have been configured.



## Monitoring & operation

The following settings can be managed via the monitoring & operation section.

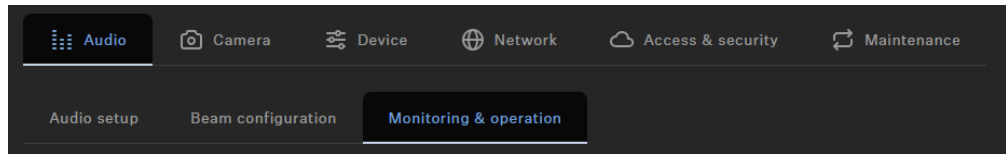

### Speaker Output

Slider for adjusting the audio output level by up to 100 %.

### USB Input

Shows the output level of the currently connected USB device, which is fed into the TC Bar as the input level.

## Setting the volume (remote control)

You can adjust the volume by using the remote control or your control application.

**i** You can also adjust the volume using the system settings of the operating system used, the conference system used (e.g., MS Teams, Zoom, etc.) or the control panel in Sennheiser's control software.

The volume can be adjusted within a range from 0 to 100.

Examples:

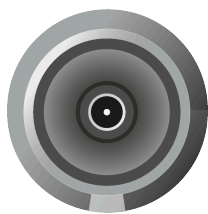

Volume 0

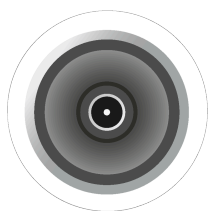

Volume 100



## WARNING



### Danger due to high volume levels

Volume levels that are too high may damage your hearing.

- ▶ Reduce the volume and the microphone amplification, if applicable, before using the product.

- ▶ Adjust the volume of the speakers to the desired level by doing one of the following:

- Press the volume buttons on the remote control.

- ✓ The LED indicates the current volume setting.

- ✓ The volume has been set.



## Camera

An overview of camera settings and controls.

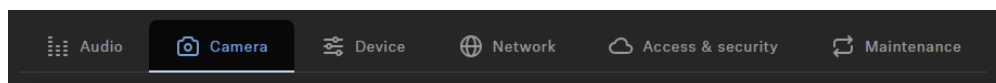

### White Balance

Adjusts the video image for natural color representation. The white balance can be set either automatically or manually.

### Brightness

Adjusts the brightness of the video image from **-12** (dark) to **12** (very bright).

### Contrast

Adjusts the contrast between light and dark parts of the video image from **1** (low contrast) to **10** (high contrast).

### Saturation

Adjusts the color saturation of the video image from **0** (low saturation) to **10** (high saturation).

### Sharpness

Adjusts the level of detail in the video image.

### Lowlight Compensation

Increases the camera sensitivity in scenes with low lighting. Either Backlight Compensation or Lowlight Compensation can be used.

### Antiflicker Frequency

Reduces image flickering caused by AC driven lighting sources.

### Autoframe Speed

Controls the speed of automatic zooming.

### Zoom Speed

Controls the speed of manual zooming.



## Pan and Tilt Speed

Controls the pan and tilt speed of the camera.

## Remote Button Control Config

Activates or deactivates functions Auto Framing and/or Person Tiling on the remote control.

## Creating a user-defined device profile

You can create a user-defined profile using .

You can adjust the individual camera settings in the device profile **Custom**. You can configure the following settings for the camera:

- **Zoom speed:**
  - Regulates the speed of the automatic zoom in a video image.
- **Auto frame speed:**
  - Regulates the switching speed of the windows between the participating areas.
- **Backlight compensation:**
  - Increases the camera's exposure in the event of backlighting. Either the backlight compensation or the lowlight compensation function can be used.
- **Exposure:**
  - Adapts the camera to scenes with different lighting conditions. The exposure can be set automatically or manually.
- **Lowlight compensation:**
  - Increases the camera's sensitivity for scenes with low lighting. Either the backlight compensation or the lowlight compensation function can be used.
- **Sharpness:**
  - Adjusts the level of detail in the video image.
- **White balance:**
  - Adapts the video image so the colors are portrayed naturally. The white balance can be set either automatically or manually.
- **Saturation:**
  - Adapts the color saturation of the video image from 0 (low saturation) to 10 (high saturation).
- **Contrast:**
  - Adapts the contrast between the light and dark parts of the video image from 1 (low contrast) to 10 (high contrast).
- **Brightness:**
  - Adjusts the brightness of the video image from -12 (dark) to 12 (very bright).

**i** When the device profile is changed, the camera settings are reset, and the device is rebooted.



**To configure the camera:**

- ▶ In , navigate to **Camera**.
- ▶ Adjust the settings for the camera in the corresponding windows.

✓ The user-defined device profile has been created.

## Setting the white balance

The white balance adapts the video image so the colors are portrayed naturally.

The white balance can be set either automatically or manually between 2800 K and 6500 K.

**To set the white balance automatically:**

- ▶ In , navigate to **Camera**.
- ▶ In the field **White Balance**, activate the button **Auto**.
- ✓ The white balance is set automatically.

**To set the white balance manually:**

- ▶ In , navigate to **Camera**.
- ▶ In the field **White Balance**, deactivate the button **Auto**.
- ▶ Set the value you want between 2800 K and 6500 K.

✓ The white balance has been set.



## Setting brightness

This setting adjusts the brightness of the video image.

The brightness can be adjusted manually within a range of -12 to 12.

### To adjust the brightness:

- ▶ In , navigate to **Camera**.
- ▶ Set the value you want from -12 (dark) to 12 (very bright) in the **Brightness** field.

✓ The brightness has been set.



## Setting contrast

This setting adjusts the contrast between the light and dark parts of the video image.

The contrast can be set manually from 1 (low contrast) to 10 (high contrast).

### To set the contrast:

- ▶ In , navigate to **Camera**.
- ▶ In the **Contrast** field, set the value you want from 1 (low contrast) to 10 (high contrast).

✓ The contrast has been set.



## Setting saturation

This setting adjusts the saturation of the video image.

The saturation can be set from 0 (no change) to 10 (high saturation).

### To set the saturation:

- ▶ In , navigate to **Camera**.
- ▶ In the **Saturation** field, set the value you want from 0 (no change) to 10 (high saturation).

✓ The saturation has been set.



## Setting sharpness

This setting adjusts the sharpness of the video image.

The sharpness can be set from 0 (no change) to 6 (very sharp).

### To set the sharpness:

- ▶ In , navigate to **Camera**.
- ▶ In the **Sharpness** field, set the value you want from 0 (no change) to 6 (very sharp).

✓ The sharpness has been set.



## Activating lowlight compensation

Lowlight compensation increases the camera's sensitivity for scenes with insufficient lighting.

Either the backlight compensation or the lowlight compensation function can be used.

### To activate the lowlight compensation function:

- ▶ In , navigate to **Camera**.
- ▶ Activate the function in the field **Lowlight Compensation**.

✓ Lowlight compensation has been activated.



## Activating backlight compensation

Backlight compensation increases the camera's exposure in the event of backlight.

Either the backlight compensation or the lowlight compensation function can be used.

### To activate backlight compensation:

- ▶ In , navigate to **Camera**.
- ▶ Activate the function in the field **Backlight Compensation**.

✓ Backlight compensation has been activated.



## Setting the anti-flicker frequency

The anti-flicker frequency reduces flickering in the image that is caused by sources of light powered by alternating current.

The following settings can be selected:

- Off
- Automatic
- 50 Hz
- 60 Hz

### To set the anti-flicker frequency:

- ▶ In , navigate to **Camera**.
- ▶ Select the desired setting in the drop-down menu.

✓ The anti-flicker frequency has been set.



## Setting the auto frame speed

The auto frame speed controls the speed of the automatic zoom.

The following settings can be selected:

- Slow
- Medium
- Fast

### To set the auto frame speed:

- ▶ In , navigate to **Camera**.
- ▶ Select the desired setting in the drop-down menu.

✓ The auto frame speed has been set.



## Setting the zoom speed

The zoom speed controls the speed of the manual zoom.

The following settings can be selected:

- Slow
- Medium
- Fast

### To set the zoom speed:

- ▶ In , navigate to **Camera**.
- ▶ Select the desired setting in the drop-down menu.

✓ The zoom speed has been set.



## Setting the panning and tilting speed

The panning and tilting speed controls the speed at which the camera pans and tilts.

The following settings can be selected:

- Slow
- Medium
- Fast

### To set the panning and tilting speed:

- ▶ In , navigate to **Camera**.
- ▶ Select the desired setting in the drop-down menu.

✓ The panning and tilting speed has been set.



## Activating the functions for remote control

Activate the auto framing and person tiling functions so you can use them conveniently via remote control.

You can activate and deactivate the auto framing and person tiling functions via remote control only after activating this function.

### To activate the functions for remote control:

- ▶ In , navigate to **Camera**.
- ▶ In the field **Remote Button Control Config**, activate the desired function in order to be able to call it up via remote control.

✓ The functions were activated for remote control.



## Enabling auto framing

The **Auto framing** function focuses on participating people in the room and guarantees this focus at all times.

- i** The **Auto Framing** function can be activated and deactivated only by remote control. For this to be possible, the output function for remote control must be activated using (see [Activating the functions for remote control](#)).

### To activate auto framing:

- ▶ Briefly press the **Auto Framing** button on the remote control.
- ✓ The camera LED switches to the following display:

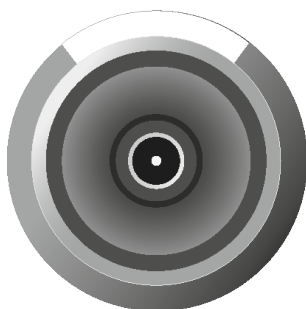

- ✓ Auto framing has been activated.



## Enabling person tiling

The **Person tiling** function records all participating people in the room during a conference and provides the video signal in a form that is suitable for the far end.

- i** The **Person Tiling** function can be activated and deactivated only by remote control. For this to be possible, the output function for remote control must be activated using the (see [Activating the functions for remote control](#)).

### To enable person tiling:

- ▶ Briefly press the **Person Tiling** button on the remote control.
- ✓ The camera LED switches to the following display:

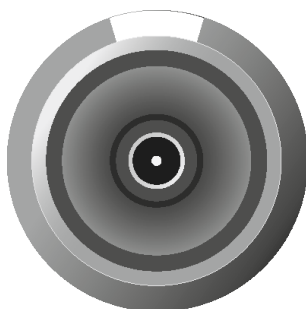

- ✓ Person tiling has been enabled.



## Setting default camera mode

Set a persistent default camera mode so the device always starts in the selected mode, ensuring a consistent experience without manual adjustments, even after a reboot or wake-up.

You can configure a persistent default camera mode, which will be applied before starting a call. During an active call, you can change the camera mode temporarily using the IR remote. These changes apply only to the current session and do not modify the configured default.

After the call ends or the device restarts, the system reverts to the stored default camera mode.

### To set up a default camera mode:

- ▶ In , navigate to **Camera**.
- ▶ Click the drop-down list under **Default Camera Mode**.
- ▶ Choose between the displayed modes:
  - **Resume Last View (Default)**: In this mode, the last saved changes will be applied.
  - **Full Field of View**: Displays the entire field of view.
  - **Auto Framing**: Focuses on participants in the room and maintains this focus at all times.
  - **Person Tiling**: Automatically divides recorded participants into individually tailored frames.
  - **User Preset**: All user configured camera settings will be applied.

✓ The default camera mode has been set.



## Device

An overview of the device's key features and specifications.

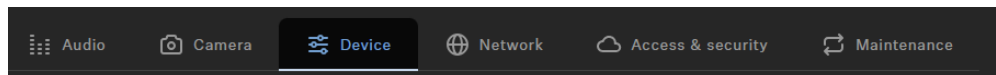

### LED Brightness

Slider for adjusting the LED brightness.

- **Off:** the LEDs are switched off completely
- **1 ... 5:** adjusts the brightness between low (1) and high (5)

### Sound Prompts

Activates or deactivates all integrated sounds of the TC Bar with the exception of the welcome prompt.

### HDMI output

Activates the HDMI output signal to external display.

- i** If you select "Microsoft Teams" as the "Device Profile", the HDMI output is deactivated.

### Device Profile

Here you can select the desired device profile, which is applied either from your own configured settings or from the predefined settings of the selected conference and collaboration platform.

- i** When changing the device profile, the camera settings will be reset and the device will be restarted.

- **Custom:** own device profile
  - Enables all settings in the **Camera** tab as well as the HDMI output in the **Device** tab
- **Microsoft Teams:** predefined by Microsoft Teams



**i** Using this profile, the camera zoom of the TC Bar is reduced to comply with Microsoft Teams specification.

- Enables the default settings for Microsoft Teams
- Resets all settings in the **Camera** tab
- Disables the HDMI output in the **Device** tab
- Reboots the device
- **Zoom:** predefined by Zoom

**i** Using this profile, the camera zoom of the TC Bar might be changed to comply with Zoom specification.

- Enables the default settings for Zoom
- Resets all settings in the **Camera** tab
- Reboots the device

## Updating the firmware

When the PC running is connected to the Internet, the most recent firmware versions for all update-able devices is automatically made available.

**i** In order to use the latest features of the software and in order for all devices to work properly, we strongly recommend keeping the firmware of all devices up to date.

**i** For security reasons, firmware (FW) updates are not backward compatible; therefore, FW versions older than the currently installed version cannot be uploaded.

### ATTENTION



#### Loss of data if the firmware transfer is interrupted

If the transfer is interrupted, this may lead to a loss of data. The devices may be damaged by this.

- ▶ Do not remove any connections to the stationary devices during firmware updates.

- ▶ In , navigate to the start page.
- ✓ The Firmware Info dialog indicates the available firmware versions.



- ▶ From the drop-down list, select the firmware version you want to install.

**i** To add manually downloaded firmware, click on Add firmware file and select the downloaded file. Firmware versions downloaded automatically by are marked **via update server**. Firmware versions downloaded manually by yourself are marked **added manually**.

- ▶ Click on **Update**.
  - ✓ The firmware of the TC Bar is updated. Afterwards, the device reboots. The LED display presents a short demo.

✓ The firmware has been successfully updated.



## Setting LED brightness

This setting adjusts the brightness of the LEDs on the TC Bar.

The brightness can be set from 0 (off) to 5 (very bright).

### To set the LED brightness:

- ▶ In , navigate to **Device**.
- ▶ Set the value you want from 0 (off) to 5 (very bright) in the **LED Brightness** field.

✓ The LED brightness has been set.



## Stipulating a device profile for the camera

Device profiles contain custom or predefined settings for supported conference and collaboration platforms.

- **Custom:** Activates all the settings on the **Camera** tab and the HDMI® output on the **Device** tab.
- **Microsoft Teams:**
  - Activates the standard settings for Microsoft Teams.
  - Resets all settings on the **Camera** tab.
  - Deactivates the HDMI® output on the **Device** tab.
  - Restarts the device.

**i** This profile reduces the camera zoom of the TC Bar in order to fulfill the specifications of Microsoft Teams.

- **Zoom**
  - Activates the standard settings for Zoom.
  - Resets all settings on the **Camera** tab.
  - Restarts the device.

**i** This profile reduces the camera zoom of the TC Bar in order to fulfill the specifications of Zoom.

### To select the device profile for the camera:

**i** When the device profile is changed, the camera settings are reset, and the device is rebooted.

- ▶ In , navigate to **Camera**.
- ▶ Select the desired profile under **Device Profiles**.

✓ The device profile for the camera has been defined.



## De-/activating sound prompts

This function activates or deactivates the integrated sounds when the device is turned on and off and when the TC Bar is connected to or disconnected from other devices.

### To de-/activate sound prompts:

- ▶ In , navigate to **Device**.
- ▶ Activate or deactivate the function under **Sound Prompts**.

✓ Sound prompts were de-/activated.



## Rebooting the TC Bar

You can configure the TC Bar using the control panel in Sennheiser's control software.

**i** When the TC Bar is rebooted, all active connections are interrupted.

### To reboot the TC Bar:

- ▶ In , navigate to **Device**.
- ▶ Slide the control under **Device Restart** to the right and click **OK**.

✓ The device is rebooted.

**i** The TC Bar is also rebooted as soon as a device profile for the camera is activated in .



## Activating the HDMI® output

You can activate the HDMI® output in order to transmit video signals to external screens.

**i** Please note that the HDMI® output is always deactivated when the device profile **Microsoft Teams** is used.

### To activate the HDMI® output:

- ▶ Make sure the most recent version of the driver for DisplayLink® is installed on your connected device. You can find the most recent version on the website [DisplayLink®](#).
- ▶ In , navigate to **Device**.
- ▶ Under **HDMI® Output**, click the switch **Deactivated**.
  - ✓ The switch changes to the status **Activated**.

✓ The HDMI® output has been activated.



## Changing energy-saving mode

Adjust the device's power-saving mode according to your requirements.

You can adjust the energy-saving mode according to your infrastructure and the required use cases. Select the appropriate mode for this:

- (default)
- (optional)
- (optional)

### CAUTION



#### Increased power consumption in Always On Mode

Enabling **Always On Mode** will increase the device's power consumption. This mode bypasses energy-saving functions and keeps the device fully active at all times.

- ▶ Enable this mode only if the device must be available 24/7 for remote access.

#### To change the energy saving mode:

- ▶ In , navigate to **Device**.
- ▶ Select the mode under **Energy Saving Mode**.
- ▶ If Always On Mode was selected, confirm the message that you have been informed about the device's increased power consumption.

✓ The energy saving mode has been changed.



## Network

The following network settings are available for the TC Bar.

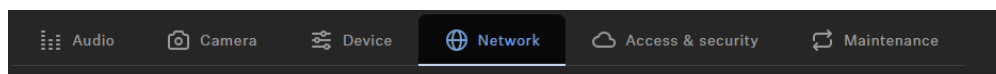

### Network Mode

Displays the Dante® Network port configuration of the selected device.

- Single Domain Mode (default mode for TC Bar and TC Bar M):
- Dual Domain Mode (for TC Bar S and TC Bar M)
- Split mode (only for TC Bar M)

#### Single Domain Mode:

- This mode is usually used if you want to use both the controller (Sennheiser or third-party provider) and Dante® on the same physical port with only one available IP in the same network. To set up both configurations, you need the Sennheiser Control Cockpit for the control network and the Dante Controller for other routed Sennheiser devices.

#### Dual Domain Mode:

- This mode is generally used if you receive a merged flow from two separate networks via a single network line and you want to resolve this merged flow back into two different IP and MAC addresses. In this way you can operate the Dante® network and the control network independently of each other via the same switch.
- Outgoing Dante® data packets are tagged as a VLAN (Virtual Local Area Network) in accordance with the 802.1q standard. The incoming data packets must also be tagged by the externally connected network in order to be able to assign them correctly for internal use. Depending on the device, the data packets may need to be translated from the outgoing 802.1q standard to 802.3 via a managed switch.

#### Split Mode:

- This mode is generally used if you receive a mixed signal from two separate networks via a single network line and want to resolve this mixed signal back into two different IP addresses. In this way, you want to operate the Dante network and the control network independently of each other and use a separate switch for each network.

### DANTE Protocols

Enables a digital audio network protocol over Ethernet for routing and synchronization of Dante-compatible devices using the Dante Controller software.



## Control/Dante Settings IPv4

### IP Mode

- **Automatic:** The IP address is automatically assigned using DHCP. If no DHCP server is available, the IP address is assigned by the SL Rack Receiver DW itself.
- **Fixed IP:** The IP address has to be entered manually.

### mDNS

- **Off:** Deactivates mDNS to reduce the data volume transferred across the network. This option is recommended for larger systems.
- **On:** Activates mDNS to allow for automatic device detection. This option is recommended for smaller systems with up to 30 devices.

### IP

- Input of the IP address in Fixed IP mode.

### Subnet

- Input of the subnet mask in Fixed IP mode.

### Gateway

- Input of the gateway in Fixed IP mode.

### DNS Server

Configure DNS servers for hostname resolution. When using a fixed IP configuration, it is essential to define at least one DNS server to ensure proper network functionality, including cloud connectivity.

Modes:

- **Automatic:** The DNS server is assigned automatically.
- **Manual:** The DNS server is assigned manually by entering the server name.

### MAC Address

Displays the unique MAC addresses of the device according to the connected ports.



## Bluetooth®

Bluetooth is deactivated by default. In order to activate BT and connect the TC Bar to a BT-compatible device:

- Click on **Enabled** to activate the BT function and wait approx. 10 sec in order to let the device process the initial activation.
- Click on **Start** to start the pairing process.
- In your device, search for your TC Bar name and click on **Connect**. If the TC Bar is not yet visible, repeat the pairing process again.

**i** Devices that have already been paired are displayed under **Known Devices**.

## Activating tagged VLAN (Dante® network)

A VLAN (virtual local area network) separates a physical network into partial networks. As a result, you can set up several virtual networks from a physically existent switch port (such as the Dante® network and control network).

The TC Bar supports the prioritizing technology **tagged VLAN** as per IEEE 802.1Q. Thus, for example, when the TC Bar S is used with only a network connection, the Dante® network and the control network can be separated virtually and operated independently. In the process, the frames for the Dante® network receive a tag (marking) that contains the VLAN ID. That is how the switch port receives information about the Dante® VLAN to which the frame belongs.

**i** When the TC Bar M is used, the Dante® network and control network can be operated independently of one another via the two existing network ports. To do this, select the network mode **Split Mode**.

### To activate tagged VLAN for a Dante® network:

- ▶ In , navigate to **Network**.
- ▶ In the **Network Mode** window, select the mode **Dual Domain Mode**.
- ▶ In the **Dante® Settings** window, click **Edit**.
- ▶ In the field **VLAN ID**, enter the correct ID in order to be routed to the correct network.
- ▶ Click **OK** to save the changes.

✓ Tagged VLAN has been activated.



## Activating Bluetooth®

When the device is delivered, Bluetooth® is deactivated and can be activated in .

- i** Please note that after the Bluetooth® function is activated, the Bluetooth® pairing process must be started in order to create a connection (see [Starting Bluetooth® pairing](#)).

### To activate Bluetooth®:

- ▶ In , navigate to **Network**.
- ▶ Under **Bluetooth**, activate the Bluetooth® switch and wait approximately 10 seconds for the operating system to activate the function.
  - ✓ The Bluetooth® function has been activated.

- ✓ You can now begin the Bluetooth® pairing process (see [Starting Bluetooth® pairing](#)).



## Starting Bluetooth® pairing

The pairing process can be started using the Bluetooth® button.

- i** Please note that Bluetooth® is deactivated in the factory settings. To create a Bluetooth® connection with a device that is capable of Bluetooth®, you must activate the Bluetooth® function in and then start the pairing process ([Activating Bluetooth®](#)).

There are several ways to start the Bluetooth® pairing process:

- Using the
- Using the initialization button on the TC Bar
- Using the remote control

### To start Bluetooth® pairing in :

- ▶ Navigate to **Network**.
- ▶ Under **Bluetooth®**, click the switch **Start**.
  - ✓ The blue LED flashes. Bluetooth pairing is activated. The device is in pairing mode and can be connected to a device that is capable of Bluetooth.



### To start Bluetooth® pairing via the TC Bar:

- ▶ Press the Bluetooth® pairing button on the left side of the TC Bar for at least three seconds.
  - ✓ The blue LED flashes. Bluetooth pairing is activated. The device is in pairing mode and can be connected to a device that is capable of Bluetooth.



**To start Bluetooth® pairing via the remote control:**

- ▶ Press the Bluetooth® pairing button on the remote control for at least three seconds.

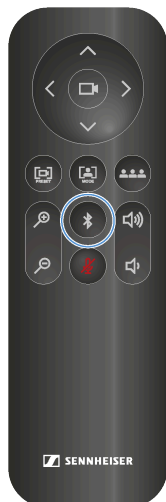

- ✓ The blue LED flashes. Bluetooth pairing is activated. The device is in pairing mode and can be connected to a device that is capable of Bluetooth.

✓ Bluetooth® pairing has begun. You can now couple the TC Bar with a device that is capable of Bluetooth® .



## Activating Dante® signal forwarding

Using the Dante controller software, you can activate a digital audio network protocol via Ethernet for the routing and a synchronization of Dante®-compatible devices.

**i** Please note that the audio signal via Dante® is not encrypted!

To route additional Sennheiser Audio devices to the TC Bar, the following steps must be performed:

- Activating the Dante® protocol in
- Forwarding the audio signals in the Dante controller

### To activate the Dante® protocol:

- ▶ In , navigate to **Network**.
- ▶ Activate the slider in the field **Dante® protocols**.
  - ✓ The Dante® protocol was activated.

### To route TCC M signals to the TC Bar, for example

- ▶ Guide the **FarEndOut** from the TCC M to **ExternalMicIn1** of the TC Bar (or **ExternalMicIn2**).
- ▶ Guide the **FarEndRefOut** of the TC Bar to the **FarEndRef** of the TCC M.

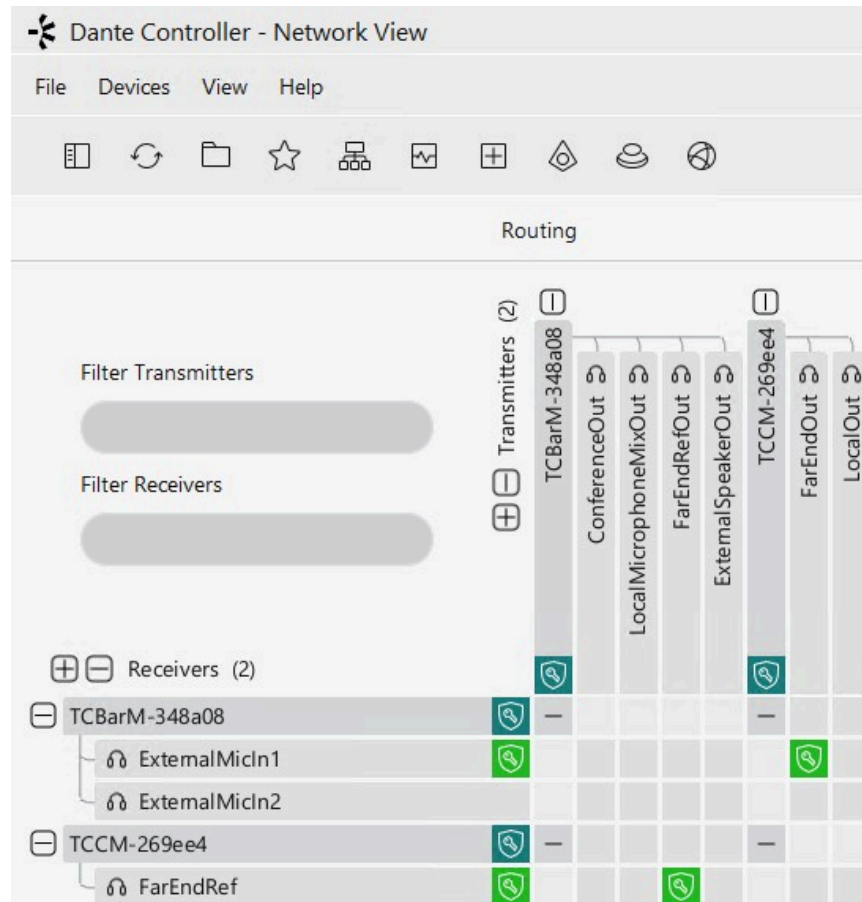

**i** We strongly recommend using the beam freeze function of the TCC M microphone. Our tests have shown that the TC Bar's echo suppression is far better when the beam freeze function is used.

✓ Forwarding AV signals via the Dante controller has been activated.



## Activating the continuous Dante® stream

This function enables the continuous transmission of microphone streams over Dante®.

- i** Audio data will be streamed permanently over Dante®. This may increase power consumption. Ensure that continuous audio streaming over Dante® complies with your regional security and regulatory requirements before enabling.

### CAUTION



#### Risk from unencrypted audio communication

Communication over Dante® is not encrypted by default and can be eavesdropped on and misused by 3<sup>rd</sup> parties.

- ▶ Enable continuous transmission over Dante® only when no sensitive content is being transmitted.
- ▶ Encrypt your communication for sensitive content using [Dante Media Encryption feature](#) in [Dante Director](#).

To enable the continuous Dante® stream:

- ▶ In , navigate to **Network**.
- ▶ Activate the toggle in the field **Continuous Dante® Stream**.

✓ The continuous Dante® stream has been activated.



## Selecting a network mode

You can configure the various network modes using the panel in Sennheiser's control software.

**The TC Bars are in the following network modes in the factory settings:**

- TC Bar S: Single domain mode
- TC Bar M: Split mode

**To select a network mode:**

- ▶ In , navigate to **Network**.
- ▶ Select a network mode from among the following options:
  - Single domain mode
  - Dual domain mode
  - Split mode (only for TC Bar M)

✓ The network mode has been selected.



## Access & Security

Overview of access and security features.

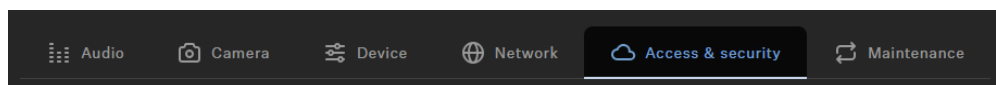

### Sennheiser DeviceHub

Enable this feature to prepare the device rollout to DeviceHub. For more information, see:

- DeviceHub
- Roll out device to DeviceHub

### Device Access

Changes the password for device access, used by Control Cockpit to authenticate to the device.

**i** Please note that the new password must meet the following requirements:

- At least ten characters
- At least one lowercase letter
- At least one uppercase letter
- At least one number
- At least one special character: !#\$%&()\*+,-./:;<=>@[^\_{}~
- Maximum length: 64 characters

### Third-Party Access

The 3rd party media control access for TeamConnect Bar is encrypted and protected using username and password. It has to be enabled using Control Cockpit before use.

**i** The full range of functions and list of callable methods can be found in the media control protocol for the TeamConnect Bar ([see 3rd party for TeamConnect Bar](#)).

- Enables or disables 3rd party media control access. In order to enable, select the **Edit** button, activate the toggle switch, enter a 3rd party device password and select the **OK** button.
- You can use the username **api** and configured password for your API calls.

**i** If you deactivate 3rd party access, the previously set password will be deleted.



**i** Please note that the new password must meet the following requirements:

- At least ten characters
- At least one lowercase letter
- At least one uppercase letter
- At least one number
- At least one special character: !#\$%&()\*+,-./:;<=>@[!^\_{}~
- Maximum length: 64 characters

## Activating third-party access

You can activate third-party media control in if you want the TC Bar to be operated via an API.

**To activate third-party access:**

- ▶ In , navigate to **Access & security**.
- ▶ In the field **3rd Party Access**, click **Edit**.
- ▶ In the field **Access**, set the switch to **Activated**.
- ▶ Assign an access password, which is requested by a media control system during device authentication.

**i** Please note that the new password must meet the following requirements:

- At least ten characters
- One lowercase letter (a...z)
- One uppercase letter (A...Z)
- One number (0...9)
- One special character (!#\$%&()\*+,-./:;<=>@[!^\_{}~)
- Maximum length: 64 characters

- ▶ Click **OK** to save the settings.

✓ Third-party access has been activated.



## Activating device access

You can change the password for accessing the device.

### To change the password for accessing the device:

- ▶ In , navigate to **Access & security**.
- ▶ In the field **Device Access**, click **Edit**.
- ▶ Assign an access password, which is queried during instance claiming in LUI (see [Running Local Web UI \(LUI\)](#)).

**i** Please note that the new password must meet the following requirements:

- At least ten characters
- One lowercase letter (a...z)
- One uppercase letter (A...Z)
- One number (0...9)
- One special character (!#\$%&()\*+,- ./:;<=>@[!^\_{}~)
- Maximum length: 64 characters

- ▶ Click **OK** to save the settings.

✓ The password for device access was changed.



## Maintenance

In this section, you will find the maintenance procedures, along with instructions for configuring NTP servers and managing time synchronization settings on the device.

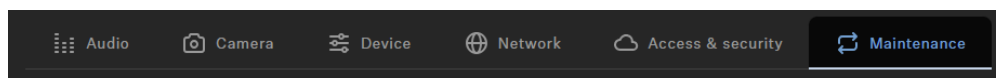

### NTP servers

Enable or disable automatic time synchronization via NTP. Choose between Automatic and Manual mode. In Manual mode, you can specify up to two NTP server addresses.

### System Time

Shows the current system time the device is operating with. If NTP is disabled, you can set the system time here.

### Audio Default Settings

Resets the audio settings (Low Cut and Sound Profiles) to the factory defaults.

**i** The last status saved in the “Location-based mute” field is retained even after you reset the audio settings to the factory defaults.

### Camera Reset

Resets the preset camera settings to default settings.

### Factory Reset

All settings of the selected device are reset to the factory defaults.

**i** The last saved status of the **Location-based mute** function is retained even after you reset the device to the factory default.

## Resetting the audio settings

You can reset all audio settings to the factory settings.



**To reset all audio settings:**

- ▶ In , navigate to **Audio > Audio Setup**.
- ▶ Slide the controller for **Audio Default Settings** to the right and confirm it with **OK**.

✓ All audio settings were reset to the factory settings.



## Resetting camera settings

You can reset all camera settings to the factory settings.

### To reset all camera settings:

- ▶ In , navigate to **Camera**.
- ▶ Slide the controller for **Camera Reset** to the right and confirm with **OK**.

✓ All camera settings were reset to the factory settings.



## Resetting the TC Bar to factory settings

You can reset the device to the factory settings manually by pressing the button on the back of the device or remotely using the control panel in .

### ATTENTION



#### Loss of data after resetting to factory settings

All active connections are interrupted, and all settings are reset to the factory settings.

All the personal data that the internal memory had recorded is irrevocably deleted.

- ▶ Make sure that no connections are being actively used at the time of the reset.
- ▶ Check whether all relevant personal data has been properly deleted.

- ▶ Reset the TC Bar to the factory settings by either:

- Holding down the reset button on the back of the device at least 7 seconds,

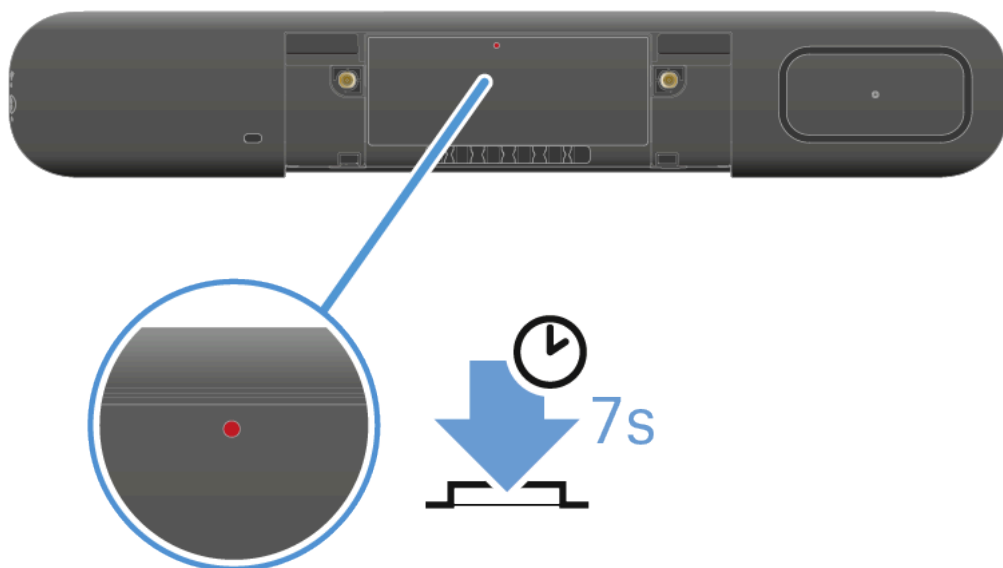

or

- In , navigate to **Maintenance**, and under **Factory Reset** slide the slider to the right. Confirm the setting with **OK**.
- ✓ There is a brief sound, and the red LED slowly flashes. The TC bar is reset and then rebooted. The white LED flashes during the boot process. A short melody sounds when the device is ready for operation.



✓ The TC Bar has been reset and is ready for operation.



## DeviceHub

DeviceHub is a centralized cloud-based platform designed for monitoring and controlling various devices seamlessly.

## Overview

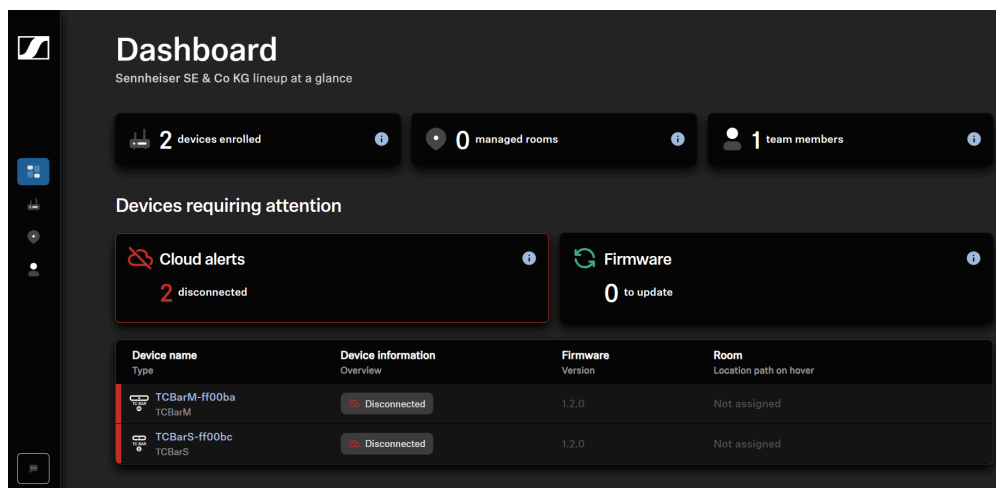

With DeviceHub, you can perform the following actions on the TC Bar:

### Get started

- [Preparing the device for DeviceHub](#)
- [Registration \(Sign-up/Sign-in\)](#)
- [Setting up organization](#)
- [Joining an organization by invite](#)

### Device enrollment

- [Running Local Web UI \(LUI\)](#)
- [Configuring NTP server](#)
- [Enabling cloud connectivity](#)
- [Enrolling devices](#)
- [Disenrolling devices](#)

### Audio

- [Audio Setup](#)
- [Beam configuration](#)
- [Monitoring & operation](#)



## Camera

- [Creating a user-defined device profile](#)
- [Activating the functions for remote control](#)
- [Enabling auto framing](#)
- [Enabling person tiling](#)
- [Setting default camera mode](#)

## Device

- [Updating the firmware](#)
- [Setting LED brightness](#)
- [Stipulating a device profile for the camera](#)
- [De-/activating sound prompts](#)
- [Rebooting the TC Bar](#)
- [Activating the HDMI® output](#)
- [Changing energy-saving mode](#)

## Network

- [Activating tagged VLAN \(Dante® network\)](#)
- [Activating Bluetooth®](#)
- [Starting Bluetooth® pairing](#)
- [Activating Dante® signal forwarding](#)
- [Activating the continuous Dante® stream](#)
- [Selecting a network mode](#)

## Access & Security

- [Activating third-party access](#)
- [Activating device access](#)

## Maintenance

- [Resetting the audio settings](#)
- [Resetting camera settings](#)
- [Resetting the TC Bar to factory settings](#)



## Get started

Initial setup steps including registration, organization, user management, and device enrollment preparation.

Follow these steps to get started with DeviceHub and prepare your organization and devices for management.

1. Prepare your devices for DeviceHub, including network connectivity, power, and firmware checks:
  - see [Preparing the device for DeviceHub](#).
2. Register for DeviceHub and sign in with your account:
  - see [Registration \(Sign-up/Sign-in\)](#).
3. Set up your organization and define basic settings such as locations or rooms:
  - see [Setting up organization](#).
4. Invite additional users and assign appropriate roles:
  - see [Inviting users to organization](#).
5. Enroll your devices to DeviceHub and assign them to the correct rooms of your organization:
  - see [Device enrollment](#).

## Preparing the device for DeviceHub

Ensure your device is correctly set up with the latest firmware and network configuration before enrolling it in DeviceHub for effective cloud management.

Before enrolling the device in DeviceHub, make sure that it is set up correctly. This will allow you to effectively manage and monitor the device in a cloud environment.

### To prepare your device for the cloud:

- ▶ Make sure that the latest firmware image supporting cloud is installed on your device by using Sennheiser Control Cockpit, which can be downloaded here: [sennheiser.com/control-cockpit](https://sennheiser.com/control-cockpit).
- ▶ Connect the device to the network and power.
- ▶ Make sure your device network is configured properly for cloud connectivity.

✓ The device has been prepared.

The [Cloud Connectivity Guide](#) will assist you in preparing your device for a cloud connection. Please open the document and follow the instructions before enrolling your device in the cloud.



## Registration (Sign-up/Sign-in)

Learn how to sign up and sign in with a local Sennheiser account or a Microsoft account to access DeviceHub securely.

You can sign in with either a local Sennheiser account or a Microsoft account by entering your email address and password.

If a Microsoft session is already active, or after you provide valid Microsoft credentials, you are signed in and forwarded automatically.

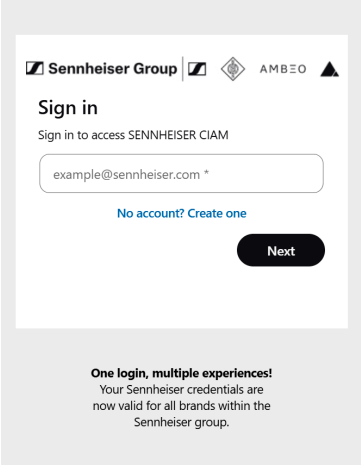
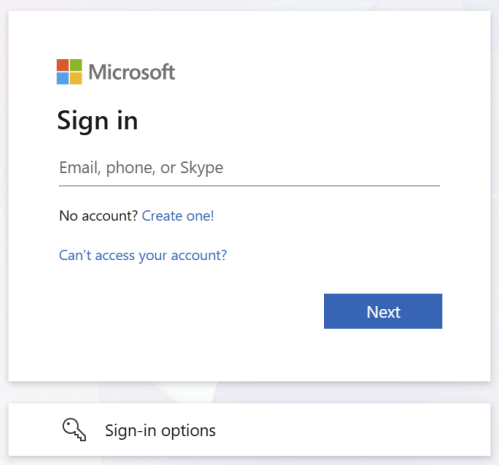
Sennheiser Group	Global Microsoft Login
 <p>The screenshot shows the Sennheiser Group sign-in page. It features the Sennheiser Group logo and the AMBEO logo. The text reads "Sign in" and "Sign in to access SENNHEISER CIAM". There is an input field for an email address with the placeholder "example@sennheiser.com *". Below the input field, there is a link "No account? Create one" and a "Next" button.</p>	 <p>The screenshot shows the Global Microsoft Login sign-in page. It features the Microsoft logo. The text reads "Sign in" and "Email, phone, or Skype". There is an input field for the email, phone, or Skype ID. Below the input field, there is a link "No account? Create one!" and a "Next" button. At the bottom, there is a "Sign-in options" link.</p>
<ul style="list-style-type: none"><li>• Sign up or sign in with a local Sennheiser account</li></ul>	<ul style="list-style-type: none"><li>• Sign in with a Microsoft account</li></ul>
<ul style="list-style-type: none"><li>• See <a href="#">Sennheiser account</a></li></ul>	<ul style="list-style-type: none"><li>• See <a href="#">Microsoft account</a></li></ul>

## Sennheiser account

Learn how to create a Sennheiser account to access DeviceHub and manage your credentials securely.

Your Sennheiser credentials are valid for all brands within the Sennheiser group.

- [Sign-up \(Sennheiser\)](#) to create a new account services.
- [Sign in \(Sennheiser\)](#) with an existing account and access the application.

## Sign-up (Sennheiser)

Register a new Sennheiser account in order to use DeviceHub.



To sign up:

- ▶ Open the DeviceHub login page at <https://devicehub.sennheiser.com/>.

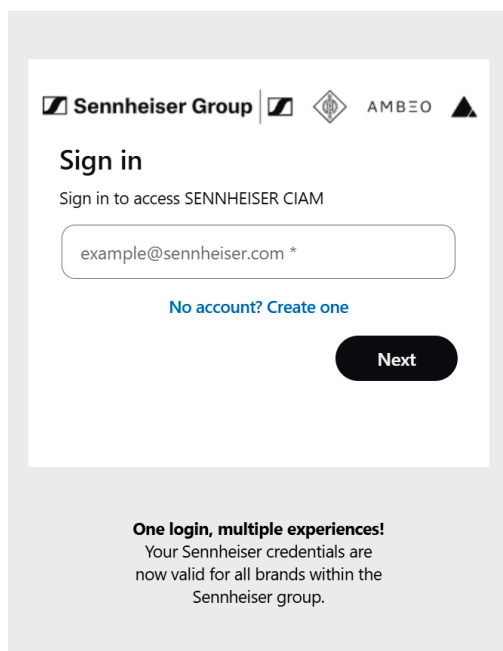

- ▶ Click on **No account? Create one.**

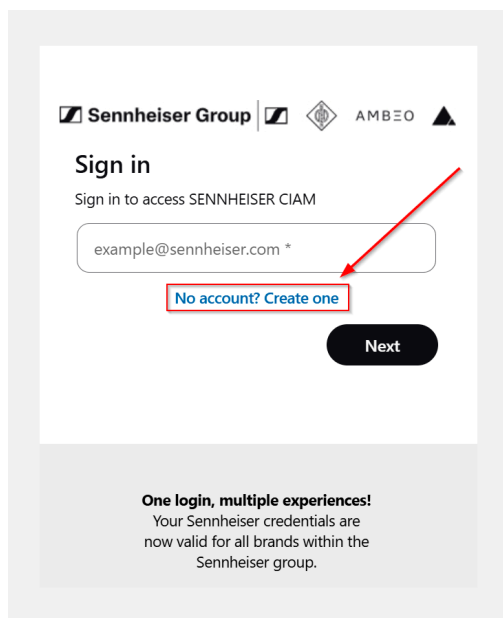

- ▶ Enter your email address in the text box.

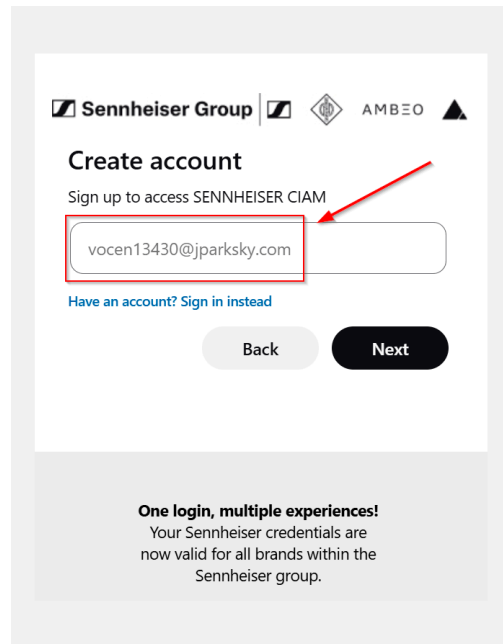

**i** To return to the sign-in page, click on **Have an account? Sign in instead** below the email text box.

✓ A One-Time Passcode (OTP) is sent to your email address to verify your account and looks like this:

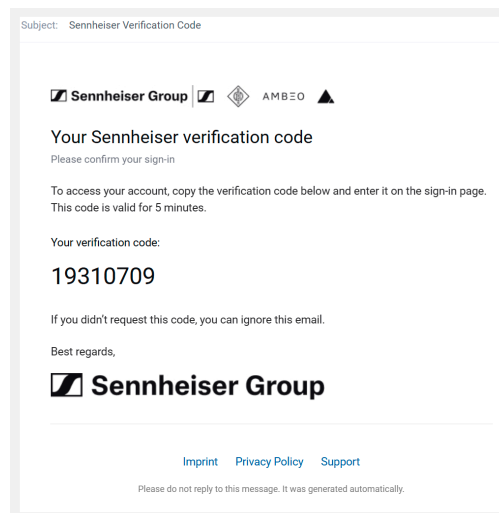

**i** OTP codes are valid for 5 minutes only.

▶ Enter the OTP on the screen.



- i** If it takes longer than expected to receive the OTP email, a hint appears indicating that you can request a new code. Click on the link **Try again** and wait for the new OTP email to arrive in your mailbox.

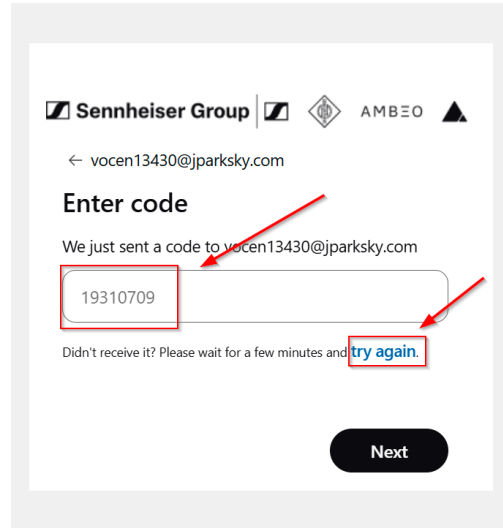

- ▶ Enter your preferred password and provide all additionally required information. You must also agree to our <https://www.sennheiser.com/de-de/legal/terms-of-use-ciam> and Security and data protection.



**i** Please note that the terms of use can be updated at any time during the CIAM lifecycle based on legal or infrastructure changes. By not accepting the terms of use, login access will be lost.

- ▶ Click on **Next**.
- ✓ You are logged in and redirected to the application where you started the process.

✓ You have signed up successfully.



## Sign in (Sennheiser)

You can sign in with an existing Sennheiser account.

To sign in:

- ▶ Open the DeviceHub login page at <https://devicehub.sennheiser.com/>.
- ▶ Enter your email address in the text box.

**i** If you can't remember your password, click the link **Forgot password?**

- ✔ In some cases, you will also be asked for a One-Time Pass code (OTP). If this happens, you will see the following screen:



- ▶ Click the message **Email code to v\*\*\*\*\*0@j\*\*\*\*\*m**.
  - ✓ This text acts as a button and sends the OTP email to you.
- ▶ Enter the OTP code that is sent to your email for verification.

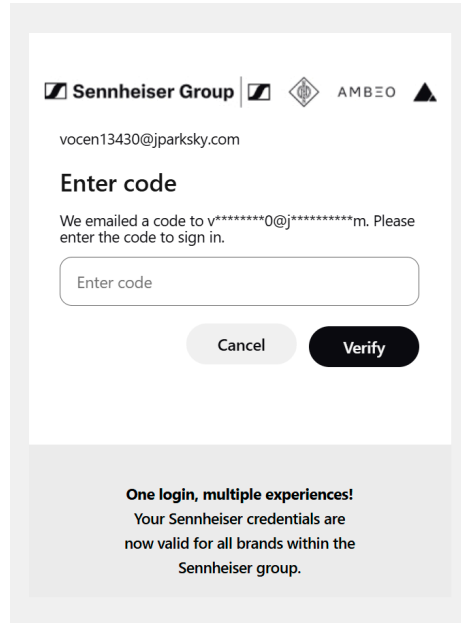



- i** If retrieving the OTP code from your email takes longer than expected, you will see a prompt to request a new code. Click the link **Resend code** and wait for the new OTP email to arrive in your mailbox.

**Sennheiser Group** | **AMBEO**

vocen13430@jparksy.com

### Enter code

We emailed a code to v\*\*\*\*\*0@j\*\*\*\*\*m. Please enter the code to sign in.

[Resend code](#)

**One login, multiple experiences!**  
Your Sennheiser credentials are now valid for all brands within the Sennheiser group.

✓ You have signed in successfully.



## Microsoft account

You can use your existing Microsoft account to sign in to Sennheiser products.

**i** Please note that you cannot use a private Microsoft account for this.

- [Sign-up \(Microsoft\)](#) to create a new account and use it for all future services.
- [Sign in \(Microsoft\)](#) to sign in with an existing account and access the application.

## Sign-up (Microsoft)

Register with the Sennheiser Identity Platform using your existing Microsoft account from your customer tenant and provide the requested additional information.

To sign up:

- ▶ Open the DeviceHub login page at <https://devicehub.sennheiser.com/>.

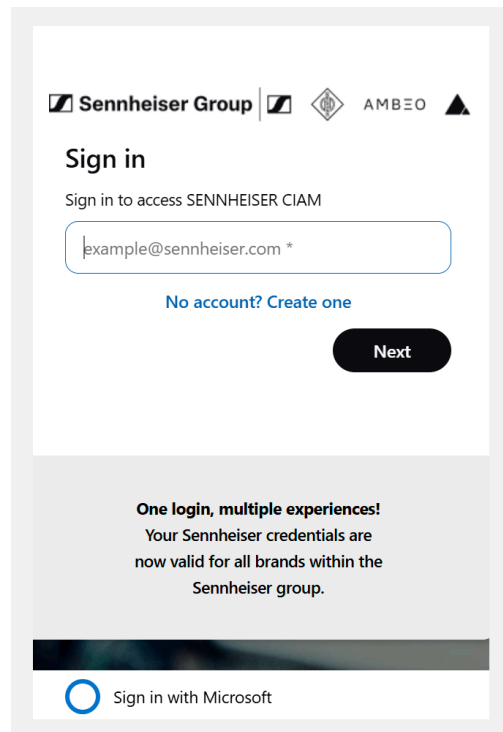

- ▶ Click **No account? Create one**.
- ✓ The Microsoft button changes from **Sign in with Microsoft** to **Sign up with Microsoft**.

You are forwarded to the common Microsoft login page.

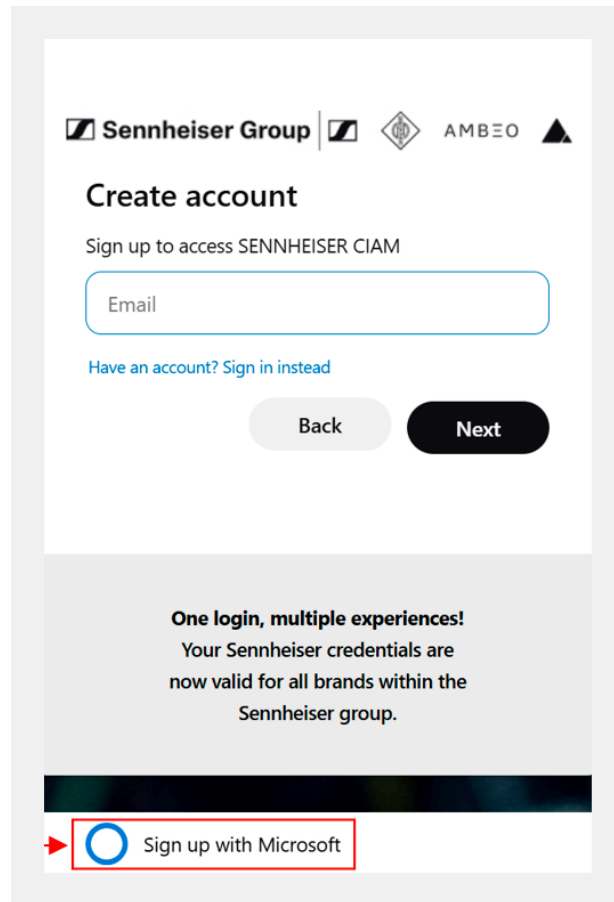

- ▶ Click on **Sign up with Microsoft** and enter your microsoft account email address.
- ✓ After you enter your account email address, you are forwarded to your company-branded login page to enter your password. If you already have an active session for this account, you do not need to enter your password again.

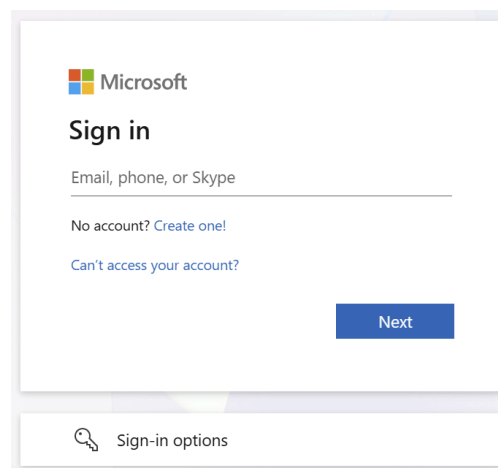



**i** Depending on your customer tenant configuration, you may be required to complete your configured MFA challenge, such as Authenticator App, Passkeys, SMS, etc. This additional MFA depends entirely on your configuration.

**i** If you are the first user in your company to use the Microsoft login from Sennheiser, it may happen that your administrator needs to approve the connection to Sennheiser. If this is the case, you are redirected to a page similar to this, where you are asked to enter a reason for the request (see [Admin approval to enable trust between tenants](#)).

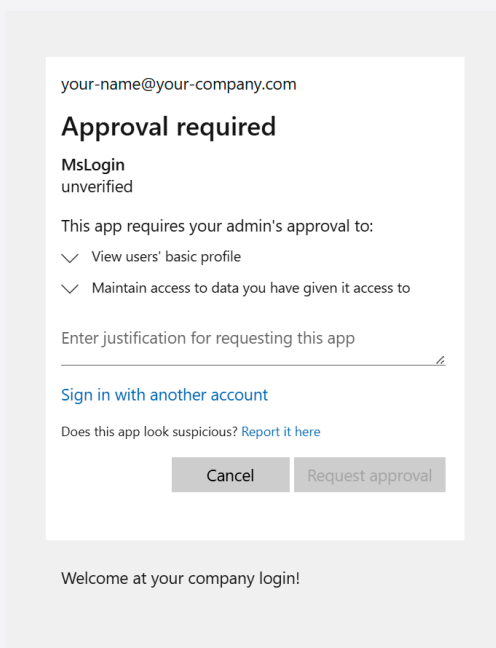

- ▶ Wait until your request has been approved by the admin.
- ✔ Once the admin approves the request, a One-Time Passcode (OTP) is sent to your email address to verify your account and looks like this:

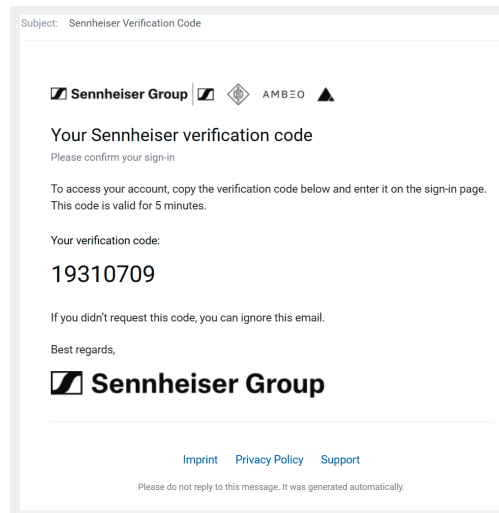

**i** OTP codes are valid for 5 minutes only.

▶ Enter the OTP on the screen.

**i** If it takes longer than expected to receive the OTP email, a hint appears indicating that you can request a new code. Click the link **Try again** and wait for the new OTP email to arrive in your mailbox.

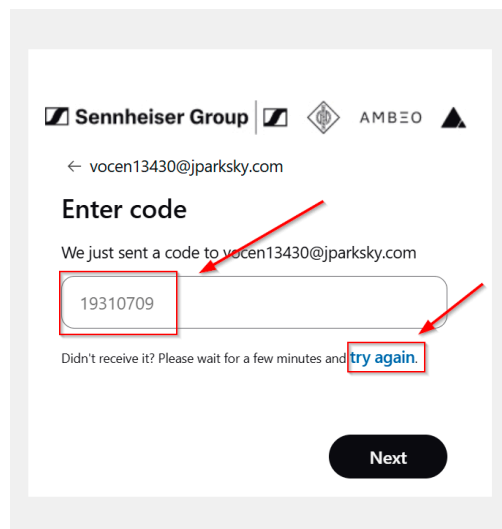

▶ Enter your preferred password and provide all additional required information. You must also agree to our <https://www.sennheiser.com/de-de/legal/terms-of-use-ciam> and Security and data protection.



**Sennheiser Group** | **AMBEQ**

### Add details

We just need a little more information to set up your account.

**Password**  
.....

**Re-enter password**  
.....

**Given Name**  
Max

**Surname**  
Mustermann

**Country/Region**  
DE

**Customer Type**  
 Business User  
 End User

**Company**  
Mustermann GmbH

I have read and agree to the [Terms of Use](#) and the [Privacy Policy](#)

**One login, multiple experiences!**  
Your Sennheiser credentials are now valid for all brands within the Sennheiser group.

**i** Please note that the terms of use can be updated at any time during the CIAM lifecycle based on legal or infrastructure changes. If you do not accept the terms of use, you will lose login access.

- ▶ Click **Next**.
- ✓ You are logged in and redirected to the application where you started the process.

✓ You have signed up successfully.



## Sign in (Microsoft)

You can sign in with an existing Microsoft account.

- i** If you are the first user in your company to use Microsoft sign-in with Sennheiser, your administrator must approve the connection to Sennheiser before you can sign in with your Microsoft account. In this case, you are redirected to a page where you must enter a reason for the request (see [Admin approval to enable trust between tenants](#)).

### To sign in:

- ▶ Open the DeviceHub login page: <https://devicehub.sennheiser.com/>.
- ✓ A new sign in/sign-up window is displayed.

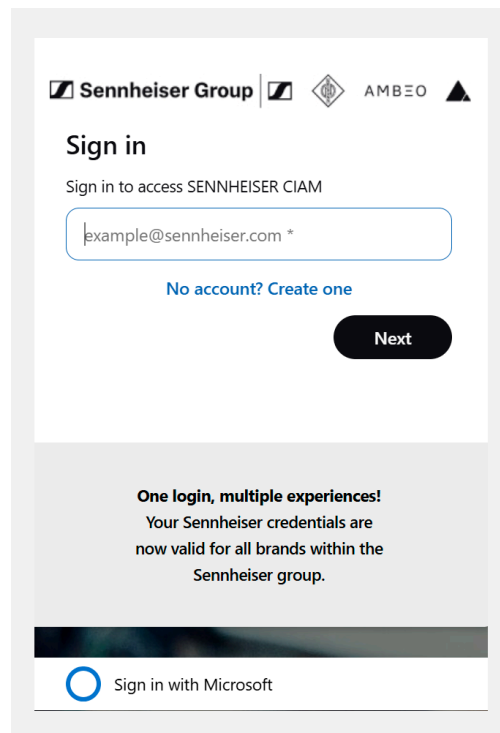

- ▶ Enter your email address and select **Sign in with Microsoft**.
- ✓ You are redirected to the standard Microsoft sign-in page.

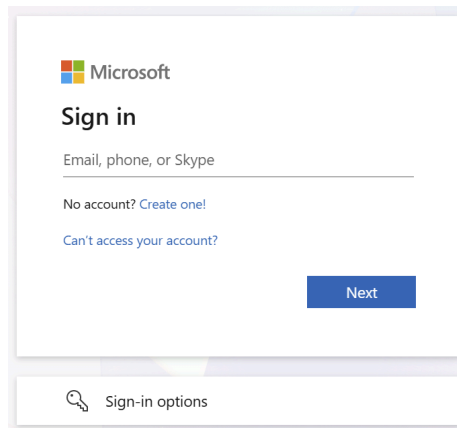

- ▶ Enter your email address again on the Microsoft sign-in page.
- ✔ After you enter your account email address, you are redirected to your company-branded login page to enter your password. If you already have an active session for this account, you may not need to enter your password again.

**i** Depending on your organization's tenant configuration, you may be required to complete a configured MFA challenge, such as an authenticator app, passkeys, or SMS code. The required MFA method depends entirely on your configuration.

A One-Time Passcode (OTP) is then sent to your email address to verify your account, for example:

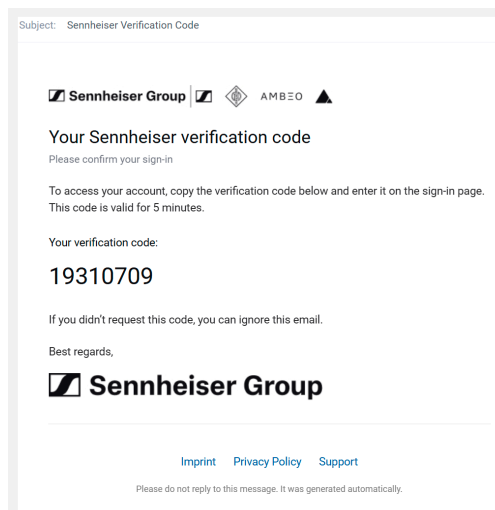

**i** OTP codes are valid for 5 minutes only.

- ▶ Enter the OTP on the screen.



- i** If it takes longer than expected to receive the OTP email, a message appears indicating that you can request a new code. Select **Try again** and wait for the new OTP email to arrive.

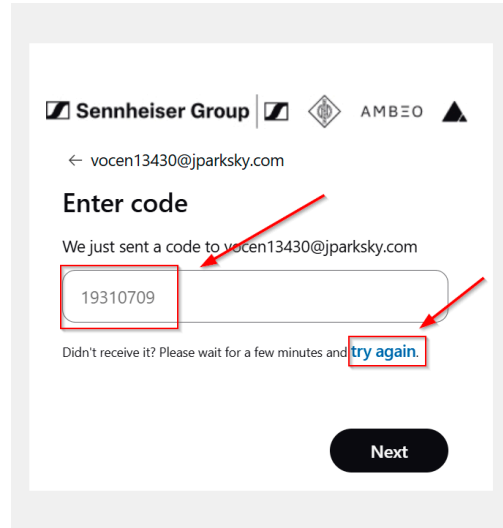

- ✓** You have signed in successfully and can now use DeviceHub with your Microsoft account.



## Admin approval to enable trust between tenants

*Audience: It-admin*

Administrators manage Microsoft permission consent requests and, once approved, users in the tenant can sign in to the Sennheiser screen with their Microsoft accounts.

As an admin, you are notified when there is a pending approval request. For more information about these requests, see the Microsoft documentation: [Request permissions that require administrative consent](#).

As an admin, you can decide whether to grant or revoke permissions. After you grant the permissions, users in this tenant can use their Microsoft accounts to [sign in](#) on the Sennheiser screen.



## Setting up organization

An organization serves as the central workspace within the cloud application, where both devices and team members are managed.

If you log in to DeviceHub for the first time without an invitation, you will be prompted to set up your own organization.

- i** Each user can create only one organization with the same email address, but they may be a member of multiple organizations by accepting invitations from others. Devices, however, can only be assigned to a single organization at any given time. To move a device to a different organization, it must first be removed from its current one before being added to the new organization.

### To set up an organization:

- ▶ Agree to the Terms of Use and the Privacy Policy and click **Start setup**.
- ▶ Enter the required details for your organization and your job role.
- ▶ Click **Finish setup** to complete the process.

✓ Your organization is now set up.

- i** The name of the active organization is always displayed at the top of the side navigation bar, enabling users to easily switch between the organizations they belong to. If you are a member of multiple organizations, you can switch organizations by:
  - Clicking the organization name at the top of the navigation bar.
  - Selecting the desired organization from the drop-down menu.



## Joining an organization by invite

Learn how to join to your organization by receiving an invitation.

**To join an organization invite:**

- ▶ Open the invitation email you received and click the link it contains.
  - ✔ You will be redirected to the DeviceHub account.
- ▶ Log in with your credentials or [create a new Sennheiser account](#).
- ▶ Finalize the onboarding process and click on **Finish setup** to complete process.

✔ You have successfully joined to your organization DeviceHub.



## Device enrollment

Follow the steps to enroll your device to DeviceHub, ensuring proper network connectivity and time configuration.

**i** The enrollment code is valid for 5 days and can be used for multiple devices. If the enrollment code is no longer valid, just create a new one and copy it in the Sennheiser DeviceHub by clicking **Add device** and **Copy code**.

After the device has been prepared for DeviceHub (see [Preparing the device for DeviceHub](#)), you can start the enrollment process with the following steps:

1. [Running Local Web UI \(LUI\)](#)
2. [Configuring NTP server](#)
3. [Enabling cloud connectivity](#)
4. [Enrolling devices](#)
5. [Disenrolling devices](#)

## Running Local Web UI (LUI)

Connect and configure your device via the embedded Local Web UI.

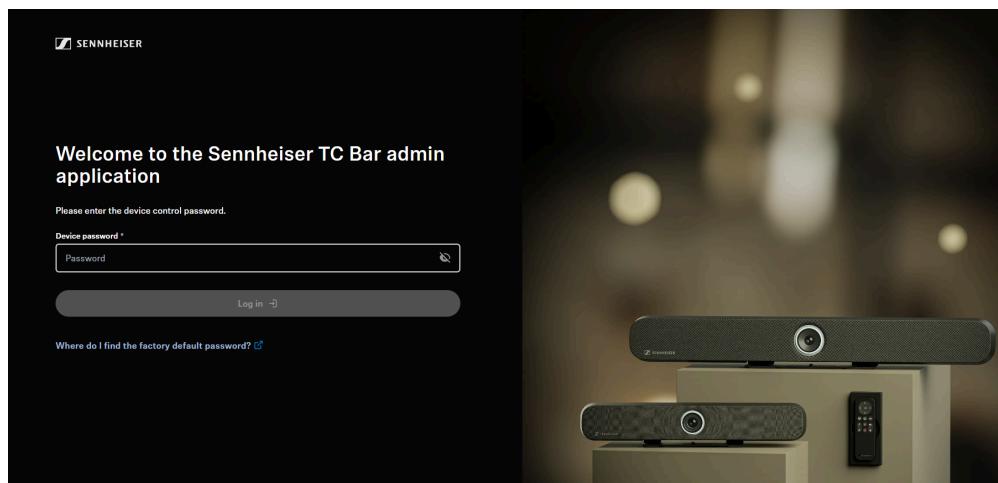

To run the Local Web UI, perform the following steps:

1. Connect the device (e. g. TC Bar) to your network.
2. Determine the assigned IP address or hostname of the device.
3. Access the device in the browser using the IP address and initialize the device upon first use.



#### To access the Local Web UI:

- ▶ In your browser, navigate to the device's IP address or hostname using "https", e.g.:  
`https://IP-address` .

**i** Your browser may display a security warning, although communication between your browser and the Local Web UI is still encrypted using HTTPS. For details, see [Security information](#).

- ▶ Depending on your browser, do the following steps:
  - Google Chrome:
    - ▶ Click **Advanced** > **Proceed to {IP address} (unsafe)**.
  - Microsoft Edge:
    - ▶ Click **Advanced** > **Continue to {IP address} (unsafe)**.
  - Mozilla Firefox:
    - ▶ In the permission dialog displayed by your operating system, click **Allow**.
    - ▶ Click **Advanced** > **Proceed to {IP address} (Risky)**.
  - Safari:
    - ▶ Click **Show Details** > **Visit this website**.
    - ▶ Confirm the permission dialog displayed by your operating system.
  - or similar (other browsers)
- ✔ You now have access to the Local Web UI.

#### To initialize the device upon first start:

- ▶ Type in the password set in the factory state, which can be found on the back of the product label under **Default password**.

**i** If the device was previously initialized by another device management solution like Sennheiser Control Cockpit, the previously set password must be entered. If you cannot remember the previously set password, please check the existing configuration setup or perform a [factory reset](#) of the device.



- ▶ If this device was not configured beforehand, you will be asked to set a new device password. Please enter a new device password for future configuration.

**i** Please note that the new password must meet the following requirements:

- At least ten characters
- At least one lowercase letter
- At least one uppercase letter
- At least one number
- At least one special character: !#\$%&()\*+,-./:;<=>?@[^\_{}~
- Maximum length: 64 characters

✓ You have successfully logged into the Local Web UI.



## Configuring NTP server

Enable NTP servers or use browser time temporarily.

The screenshot shows the 'NTP servers' configuration page. At the top right, there is a 'Maintenance' tab. The main heading is 'NTP servers' with a toggle switch set to 'On'. Below this, there is a description: 'Enable or disable automatic time synchronization via NTP. Choose between Automatic and Manual mode. In Manual mode, you can specify up to two NTP server addresses.' There are two input fields: 'Mode' with a dropdown menu currently showing 'Automatic', and 'NTP server 1' with an empty text input box.

To configure an NTP (network time protocol) server:

- ▶ In the **Local Web UI** of your device, navigate to the tab **Maintenance**.
- ▶ Set **NTP servers** to **On**.
- ▶ When activated, the system uses the NTP server provided by the DHCP server by default ("Automatic").
- ▶ If your DHCP server is not providing an NTP server or if you are using a static IP configuration, change the selection in the **NTP servers** field to "Manual" and input your NTP server. You can enter either an IP address or a DNS name.

**i** When configuring the time server, the device accepts any address or name provided via DHCP or entered manually, without verifying its reachability or validity. This feature allows for pre-configuration of the device for later use in a different environment. If time synchronization issues arise, please ensure that the configured server is accessible and is a valid NTP server.

**i** When you cannot use an NTP server, you can set the device's time to match your browser's time by clicking on "Use browser time" in the System time field.  
Please note, that this time is only kept until the next reboot/power down. To connect to the cloud after a reboot, you need to manually set the time again if not using NTP.

✓ The NTP server has been configured.



## Enabling cloud connectivity

Learn how to enable the cloud connectivity for your device.

To enable the cloud connectivity:

- ▶ In the **Local Web UI** of your device, navigate to the tab **Access & Security**.
- ▶ Under **Sennheiser DeviceHub**, switch the toggle to **On**.
  - ✓ An input form for the enrollment code is displayed.

✓ The cloud connectivity has been enabled.

Please proceed with the next step: [Enrolling devices](#)



## Enrolling devices

**Audience: Owner**

Learn how to enroll your device to DeviceHub.

To enroll your device:

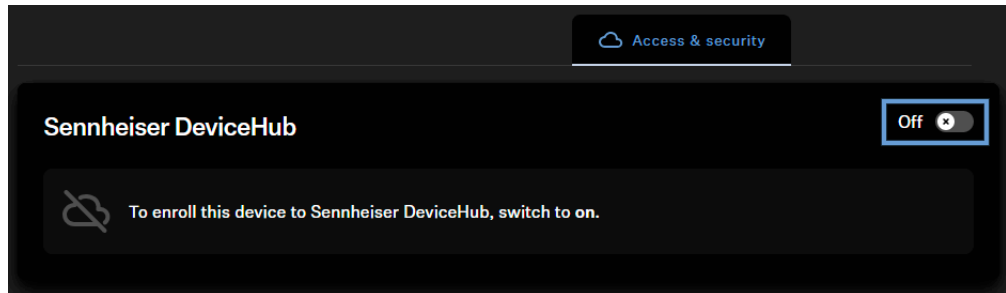

- ▶ In DeviceHub, navigate to the section **Device**.
- ▶ Click on **Add device**.
  - ✓ An enrollment code is displayed.
- ▶ Copy the enrollment code and switch to the Local Web UI of the device.
- ▶ In the Local Web UI, navigate to the tab **Access & Security** and activate the cloud connectivity under **Sennheiser DeviceHub** (if not yet done).
  - ✓ A query form with the requested activation code is displayed.
- ▶ Enter the enrollment code in the dedicated field by pasting it.
- ▶ Click on **Enroll device**.
  - ✓ Once completed, Sennheiser DeviceHub will show the enrolled device(s) in the device list.

✓ The devices have been enrolled.



## Disenrolling devices

**Audience:** Owner

Remove a device securely from DeviceHub to disconnect it from the organization and delete all device-related information in the IoT hub.

When a device is no longer in use or is temporarily stored, for example during a room renovation, you should remove it from your DeviceHub account to keep your device list clean and up to date. Each device can only be enrolled in one organization at a time. If you want to use a device in a new organization, you must first disenroll it from the previous organization.

### To disenroll your device:

- ▶ In DeviceHub, navigate to the Devices page.
- ▶ On the device you want to disenroll, click the three dots and then click **Disenroll device**.
- ▶ Confirm the disenrollment.

**i** Remember to **disable** the cloud connectivity on the device's LUI to complete the disenrollment.

- ✓ The disenrollment starts in the background and the device shows the status **disenrolling**.

**i** When the disenrollment is completed successfully, the device is removed from the DeviceHub account and a success toast confirms this. If the disenrollment fails, the device appears again in the list (in its previous state) and an error message indicates the failure.

- ✓ The device has been disenrolled.



## Audio

The following settings can be managed via the audio tab.

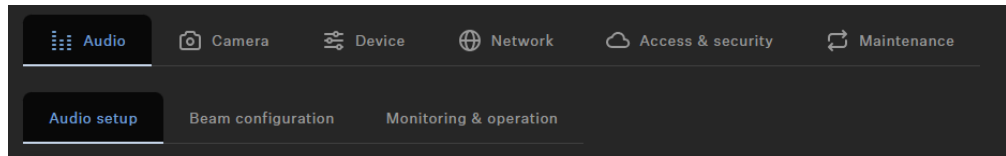

The Audio tab is divided into following sections:

- [Audio Setup](#)
- [Beam configuration](#)
- [Monitoring & operation](#)

## Audio Setup

The following settings can be managed via the audio setup section.

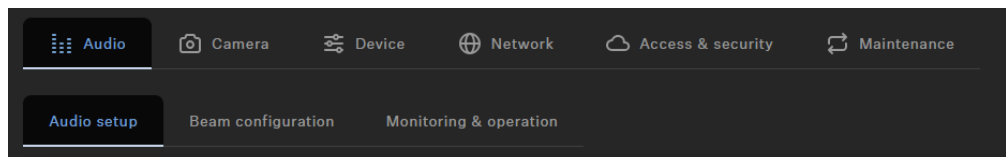

## Sound Profile

Sound profiles are presets that are optimized for the intended mounting options.

Custom: 7-band equalizer for manually adjusting or selecting preset sound settings depending on the mounting option of the device:

- Wallmount
- Table Top
- Under Display
- Above Display
- Free Standing
- Custom

## Internal Microphone Noise Gate

### Noise Gate:

Noise Gate can be activated to avoid amplification of background noise, e.g. during pauses in speech.

### Threshold:

The Noise Gate will open the audio of the microphone output only after the predefined threshold value of the needed microphone has been reached. With the slider you can adjust the minimum threshold level from -70 dB to -30 dB in steps of 1 dB.



### Hold Time:

The Hold Time sets the duration until the noise gate is activated, e.g. during speech pauses. With the slider you can adjust the duration time from 100 ms to 500 ms in steps of 50 ms.

### Range

The 'Range' parameter defines the degree of noise suppression below the set threshold for the entire Noise Gate. The parameter can be set in steps of 1 dB between 0 dB (no suppression) and 80 dB (the level is reduced by 80 dB below the threshold and after the 'attack time').

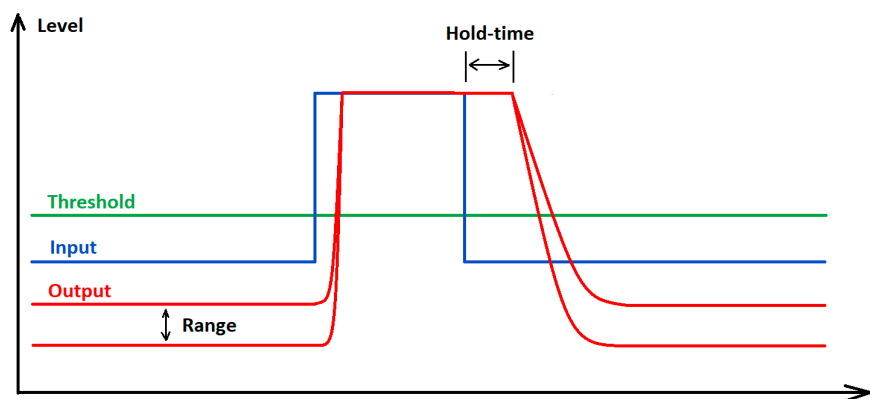

### Automix Priority

The TC Bar has up to two Dante® inputs for external microphone channels (Ext. CH 1 and Ext. CH 2). The channels allow external devices (e.g. TeamConnect Ceiling Medium) to be connected to the TC Bar via a Dante® network. The settings via the Automix Priority only manage the priority of the selected channel. It has no influence on the actual gain level of the connected microphones.

### Integrated Automixer

The Dante® inputs are managed via an integrated automixer, whereby the priority of the channels, including the internal microphone array, can be set via individual faders. Reducing the level by the corresponding control fader will add a virtual level reduction to the channel that makes it less likely to be selected by the automixer.

### Level meters

The level meters show the signal level of the inputs and the internal microphone array PRE fader and also PRE virtual level reduction. Moving the faders therefore does not change the displayed levels.

### Prioritizing a single channel

If you want to prioritize a single channel from the selection, you will have to reduce the virtual gain reduction of the other two channels. With Fade Time you can adjust the switching speed between the audio sources connected to the auto mixer.



### Active channel

The automixer provides an indicator above the channels to show the active channel. If the channel is active, the indicator changes to green. The automixer has a NOM (Number of Open Microphones) = 1, so that only one microphone can be active at a time.

### Conference Output

Controls the level of the near and far end signals at the Dante® conference output.

Slider for adjusting the digital audio output level from 0 dB to -60 dB in steps of 1 dB.

### Selecting a sound profile

Sound profiles are presets that are optimized for the intended mounting options.

You can either select a profile (recommended) or manually adjust the equalizer setting.

- ▶ In , navigate to **Audio > Audio Setup**.
- ▶ Select the installed mounting type from the drop-down list (recommended).  
**Optional:** Select **Custom** to configure your own settings.

✓ The sound profile for your TC Bar has been selected.



## Setting the internal microphone noise gate

The noise gate ensures background noises are not intensified during pauses in speech.

In principle, the internal noise suppression function is able to effectively reduce noise from the room. However, there can be instances when an additional noise gate is required. The noise gate ensures background noises are not intensified during pauses in speech. This is especially important when several microphones are used simultaneously.

During speech pauses, for instance, the system automatically increases amplification owing to the assumption that insufficient signal strength is present. This causes the background noises to be amplified unnecessarily.

### Threshold

You can stipulate a **threshold value** as of which the system mutes the microphone. The noise gate does not open the audio output of the microphone until the microphone used exceeds the stipulated threshold value. With the slider, you can adjust the minimum threshold value from -70 dB to -30 dB in increments of 1 dB.

### Hold time

The **hold time** determines how quickly the microphone reduces the amplification. A delay of up to 500 ms can be set. You can set the hold time from 100 ms to 500 ms in increments of 50 ms.

#### To set the noise gate threshold value:

- ▶ In , navigate to **Audio > Audio Setup**.
- ▶ Activate the function **Noise Gate** in the field **Internal Microphone Noise Gate**.
- ▶ Set the desired value under **Threshold**.
  - ✓ The threshold value has been set.

#### To set the hold time:

- ▶ In , navigate to **Audio > Audio Setup**.
- ▶ Activate the function **Noise Gate** in the field **Internal Microphone Noise Gate**.
- ▶ Set the desired value under **Hold Time**.
  - ✓ The hold time has been set.

✓ The internal microphone noise gate has been set.



## Handling auto mix priority

You can use the auto mix priority to set the priority of the channels, including the internal microphone arrays, via individual controllers.

The TC Bar has up to two Dante® inputs for external microphone channels (ext. CH 1 and ext. CH 2). The channels make it possible to connect external devices (e.g., TeamConnect Ceiling Medium, etc.) to the TC Bar via a Dante® network. The Dante® inputs are managed using an integrated auto mixer, whereby the priority of the channels, including the internal microphone array, can be configured using individual faders.

**i** The settings for the auto mix priority manage only the priority of the selected channel. They have no effect on the actual amplification level of the connected microphones.

When the level is decreased using the corresponding controller, a virtual level reduction is added to the channel. This makes the auto mixer less likely to select the channel. Moving the controllers does not change anything about the levels displayed.

If you want to favor an individual channel from the selection, reduce the virtual amplification of the other two channels. The lower the dB number, the more likely the channel is to be selected.

Example:

Int. mic.	Ext. CH 1	Ext. CH 2	Explanation
-30 dB	-60 dB	0 dB	<ul style="list-style-type: none"><li>• Ext. CH 2 has the highest priority and is thus selected most often.</li><li>• Int. mic. has a lower priority and is thus selected less often.</li><li>• Ext. CH 1 has the lowest priority.</li></ul>
-60 dB	-10 dB	-30 dB	<ul style="list-style-type: none"><li>• Ext. CH 1 has the highest priority and is thus normally selected.</li><li>• Ext. CH 2 has a lower priority and is thus selected less often.</li><li>• Int. mic. has the lowest priority.</li></ul>
0 dB	-30 dB	-30 dB	<ul style="list-style-type: none"><li>• Int. mic. has the highest priority and is thus normally selected.</li><li>• Ext. CH 1 and 2 have a lower priority and are thus selected less often.</li></ul>



## Configuring fade time

You can use the fade time to configure the speed at which the devices switches between the audio sources connected to the auto mixer.

- ▶ In , navigate to **Audio > Audio Setup**.
- ▶ Start by reducing the int. mic. by -30 dB.
- ▶ Speak in various positions and listen to whether the sound meets your expectations on the other end of a telephone conference.
- ▶ Select different values for the fade time and listen to the transition from one microphone to another.

✓ The fade time has been configured.



## Adapting far end output for TCC M

You can adapt the amplification of the TCC M signal with far end output.

The standard settings in TCC M are tailored to common application cases. In certain scenarios, you can use the following settings on the Audio tab to finely adjust the output.

### To adapt the amplification in the Far End Output (digital) field of the TCC M:

- ▶ In the Control Cockpit, navigate to **Devices > TCC M > Audio**.
- ▶ Increase the amplification in the field **Far End Output (digital)** if the TCC M is very far from the audience.
- ▶ Decrease the amplification if the TCC M is very close to the audience.

### To configure the sensitivity of the beam freeze:

- ▶ In the Control Cockpit, navigate to **Devices > TCC M > Audio**.
- ▶ Increase the input level under **Manual gain** to activate the beam freeze earlier and thus achieve better echo suppression.
- ▶ Decrease the input level to improve the near end and double talk.
- ▶ Select **Automatic gain** if the seating in a room changes often, for example. Doing so allows the TCC M microphone to adjust itself to the best input level.

✓ The far end output was adjusted.



## Muting internal TC Bar microphone

Use the remote control or your control software to mute or unmute the internal microphone.

- i** Muting the microphone can also be activated or deactivated using the system settings of the operating system and/or conference system in use (e.g., MS Teams, Zoom, etc.).

### Muting the TC Bar

- ▶ To mute the internal microphone of the TC Bar
  - Briefly push the mute button on the remote control or

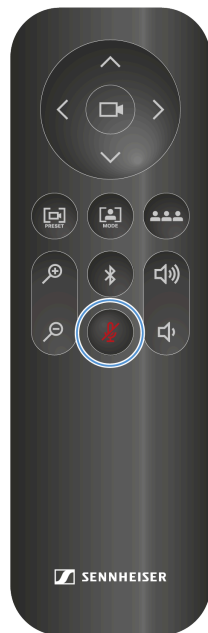

- In , navigate to **Audio > Audio Setup** and deactivate the setting **Internal Mic Mute**.

- ✓ The lower LED for audio settings shines red. Muting is activated.

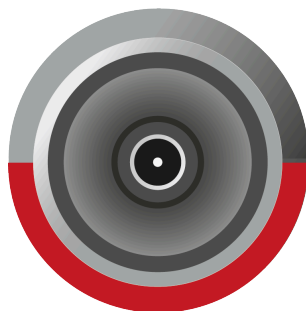



**Stop muting:**

- ▶ Stop the muting by doing the following:
  - Briefly push the mute button on the remote control or
  - In , navigate to **Audio > Audio Setup** and deactivate the setting **Internal Mic Mute**.
- ✓ The red LED goes out. The audio output is no longer muted.

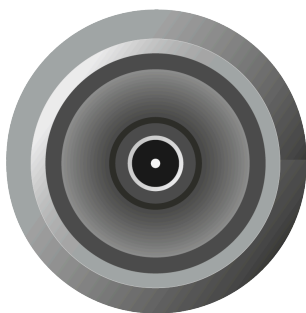

- ✓ The TC Bar has been muted.



## Muting all microphones

Mute all input channels with a single click.

**i** This function mutes all microphone input channels:

- Internal microphone
- External CH1
- External CH2

### To mute all input channels:

- ▶ In , navigate to **Audio > Audio Setup**.
- ▶ Enable the slider labeled **All Microphones Mute**.
  - ✓ The lower LED for audio settings lights red, indicating muting is active.

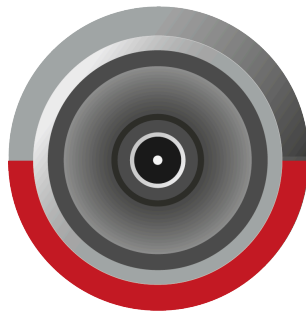

✓ All input mic channels have been muted.



## Enabling Dante® speaker output

Route audio to external Dante® speakers and disable the device's internal speakers.

When enabled, audio output is routed to external Dante® speakers and the device's internal speakers are muted.

- i** Before enabling this function, ensure that the Dante® protocols are enabled (see [Activating Dante® signal forwarding](#)). Also verify that routing has been configured in Audinate Apps before activation; otherwise, echo effects may occur.

### To enable the Dante® speaker output:

- ▶ In , navigate to **Audio > Audio Setup**.
- ▶ Activate the slider in the field **External Dante® speaker output**.

✓ Audio output is routed to the external Dante® speakers.



## Activating location-based mute

You can mute several devices in a room at the same time by using the mute switch on any transmitter.

In order to do so, you must add the device to the mute group for the location.

The following functions are available:

### Deactivated

The TC Bar is not part of a mute group. Muting or unmuting does not affect other transmitters.

### Part of group

Activate this function to add the TC Bar to a mute group. If one of the transmitters in this mute group is subsequently muted, all other transmitters in the same mute group at the same location will be muted or unmuted at the same time. This is how you can create your own mute group for each location.

**i** If you use the regular mute function via the TC Bar with a routed TCC M, we recommend setting the LED brightness of the **TCC M** to **0**. The mute function can be displayed only on the TC Bar, not on the TCC M.

## CAUTION



### Danger due to high volume levels

If the TCC M is routed, undesired echoes may occur if **Location-based Mute** is used during a conference. During muting, the microphone input current is paused, and, accordingly, the AEC cannot always assess the impulse response from the far end.

- ▶ Avoid using this function in combination with a routed TCC M.
- ▶ If you use the function, reduce the volume and, if applicable, the microphone amplification before reactivating this function.

To activate the location-based mute function:

- ▶ In , navigate to **Audio > Audio Setup**.
- ▶ Activate the function **Location-based Mute**.
  - ✓ The display switches to **Part of group**.

✓ Location-based mute has been activated.



## Beam configuration

The following settings can be managed via the beam configuration section.

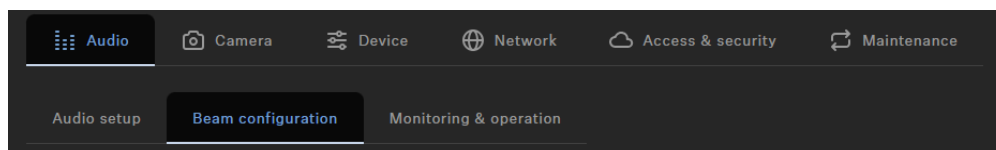

The TeamConnect Bar allows you to define two different types of zones:

- One Priority Zone - Zone to be preferred
- Up to three Exclusion Zones - Zones to be excluded

For each zone the horizontal angles can be set individually.

### Priority Zone

**i** In case both zone types overlap, the rules of the Exclusion Zone will apply.

The Priority Zone allows you to set up a zone which will be handled prioritized in case of incoming audio signals from different positions at the same time. This feature can be useful e.g. during conference meetings with an important person involved.

You can adjust a weighting for this zone. The weighting increases the focus on the incoming signals from the zone by the selected values. The following settings can be made:

- **Mid:** Increases the weighting on the audio output from the zone by about 1.5 times the normal value.
- **High:** Increases the weighting on the audio output from the zone by about 2.5 times the normal value.
- **Max:** Increases the weighting on the audio output from the zone by about 4 times the normal value.

**i** When defining the Priority Zone the area to be prioritized in the detection of the audio source is indicated green.

You can adjust the slider to set a Priority Zone. The zone can be adjusted individually from 15° to 165°. Minimum size for the angle: 15°.

### Exclusion Zones

**i** In case both zone types overlap, the rules of the Exclusion Zone will apply.



The TC Bar allows you to define up to three exclusion zones. By activating these zones all outgoing audio signals from these areas will be neglected.

**i** When defining the Exclusion Zones the area to be excluded in the detection of the audio source is indicated petrol.

You can adjust the sliders to set the exclusion zone. The horizontal zone can be adjusted individually from 15° to 165°.

## Overview

When you activate the zones, a 2D overview is created on the right, which displays all activated zones in real time. The zones in the 2D model are indicated either green (prioritized) or petrol (excluded).

## Beam configuration

The following settings can be managed via the beam configuration section.

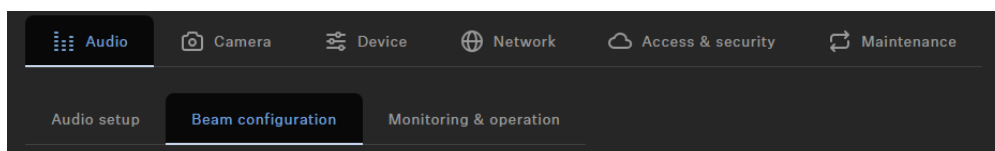

The TeamConnect Bar allows you to define two different types of zones:

- One Priority Zone - Zone to be preferred
- Up to three Exclusion Zones - Zones to be excluded

For each zone the horizontal angles can be set individually.

## Priority Zone

**i** In case both zone types overlap, the rules of the Exclusion Zone will apply.

The Priority Zone allows you to set up a zone which will be handled prioritized in case of incoming audio signals from different positions at the same time. This feature can be useful e.g. during conference meetings with an important person involved.



You can adjust a weighting for this zone. The weighting increases the focus on the incoming signals from the zone by the selected values. The following settings can be made:

- **Mid:** Increases the weighting on the audio output from the zone by about 1.5 times the normal value.
- **High:** Increases the weighting on the audio output from the zone by about 2.5 times the normal value.
- **Max:** Increases the weighting on the audio output from the zone by about 4 times the normal value.

**i** When defining the Priority Zone the area to be prioritized in the detection of the audio source is indicated green.

You can adjust the slider to set a Priority Zone. The zone can be adjusted individually from 15° to 165°. Minimum size for the angle: 15°.

### Exclusion Zones

**i** In case both zone types overlap, the rules of the Exclusion Zone will apply.

The TC Bar allows you to define up to three exclusion zones. By activating these zones all outgoing audio signals from these areas will be neglected.

**i** When defining the Exclusion Zones the area to be excluded in the detection of the audio source is indicated petrol.

You can adjust the sliders to set the exclusion zone. The horizontal zone can be adjusted individually from 15° to 165°.

### Overview

When you activate the zones, a 2D overview is created on the right, which displays all activated zones in real time. The zones in the 2D model are indicated either green (prioritized) or petrol (excluded).



## Overview

The zones overview displays all activated zones in an overall display.

If you activate the zones, a 2D overview is created on the right-hand side and displays all the activated zones in real time. The zones in the 2D model are marked either green (prioritized) or petrol blue (excluded).

**i** If both zone types overlap, the rules of the exclusion zone apply.



## Creating a priority zone

You can use a priority zone to prioritize an important audio area in a room (such as the position of a speaker).

During lively discussions in meetings, the moderator must be able to retain control of the conversation. You can create a priority zone so that voices have priority for reasons besides volume alone. The moderator is always preferred in the incoming signal, even if their voice is quieter. That ensures that the person responsible always has control of the situation regarding voices as well.

You can also configure weighting for the priority zone. The weighting determines how intensively the beam concentrates on this area. You have the following options:

### Mid

- Increases the weighting of the audio signals in the priority zone to approximately 1.5 times the normal audio output (e.g., in rooms with normal ambient noise). Thus, the source outside the priority zone must be 2 dB louder than a source within the priority zone to cause the beam to focus on the source outside the zone.

### High

- Increases the weighting of the audio signals in the priority zone to approximately 2.5 times the normal audio output (e.g., in rooms with high ambient noise). Thus, the source outside the priority zone must be 4 dB louder than a source within the priority zone to cause the beam to focus on the source outside the zone.

### Max

- Increases the weighting of the audio signals in the priority zone to approximately 4 times the normal audio output (e.g., in rooms with strong ambient noise and a quiet moderator). Thus, the source outside the priority zone must be 6 dB louder than a source within the priority zone to cause the beam to focus on the source outside the zone.

**i** If the priority zone overlaps the exclusion zones, the settings for the exclusion zones apply.

### To configure a priority zone:

- ▶ In , navigate to **Audio > Beam Configuration**.
- ▶ Under **Priority Zone**, click the button **Off** to activate the zone.
  - ✓ The switch then changes to the mode **On**.
- ▶ Click **Edit**.



- ▶ Configure the desired priority zone manually in the specified radius.
- ▶ Click **Apply** to save the settings.
  - ✓ The priority zone has been set.

**To set the weighting of the priority zone:**

- ▶ Under **Priority Zone > Weight**, select the desired setting from among the values **Mid**, **High** or **Max**.
  - ✓ The weighting has been set.

✓ The priority zone has been configured.



## Configuring exclusion zones

You can use exclusion zones to exclude unwanted areas from audio recording.

Air conditioners, side doors, loud coffee machines, and adjoining rooms can produce undesired noises. Speakers with audio signals from distant participants can also be a source of disruption for the microphone.

To exclude these undesired background noises, you can define exclusion zones in which the beam tracking function ignores audio signals.

You can configure up to three exclusion zones and activate them at the same time. As soon as the device is initialized, the TC Bar uses a real-time algorithm to detect sources of noise that are then visualized directly as a 2D model. That allows you to quickly and easily localize the source of disruption and define a precise exclusion zone for this area.

### To configure one or more exclusion zones:

- ▶ In , navigate to **Audio > Beam Configuration**.
- ▶ Under **Exclusion zones**, click the button **Off** for the desired zone from 1 to 3 to activate the exclusion zone.
  - ✓ The switch then changes to the mode **On**.
- ▶ Click **Edit**.
- ▶ Configure the desired exclusion zone manually in the specified radius.
- ▶ Click **Apply** to save the settings.

✓ The exclusion zones have been configured.



## Monitoring & operation

The following settings can be managed via the monitoring & operation section.

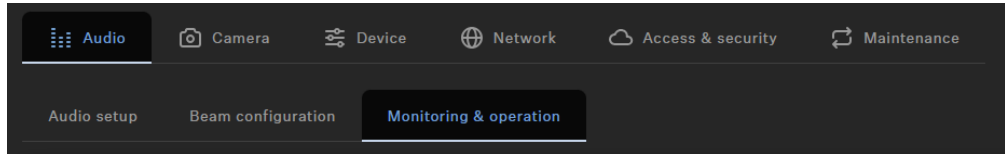

### Speaker Output

Slider for adjusting the audio output level by up to 100 %.

### USB Input

Shows the output level of the currently connected USB device, which is fed into the TC Bar as the input level.

## Setting the volume (remote control)

You can adjust the volume by using the remote control or your control application.

**i** You can also adjust the volume using the system settings of the operating system used, the conference system used (e.g., MS Teams, Zoom, etc.) or the control panel in Sennheiser's control software.

The volume can be adjusted within a range from 0 to 100.

Examples:

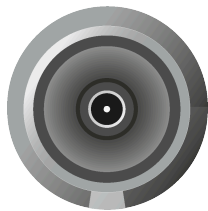

Volume 0

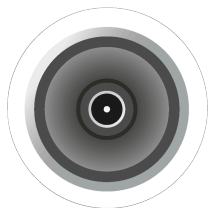

Volume 100



## WARNING



### Danger due to high volume levels

Volume levels that are too high may damage your hearing.

- ▶ Reduce the volume and the microphone amplification, if applicable, before using the product.

- ▶ Adjust the volume of the speakers to the desired level by doing one of the following:

- Press the volume buttons on the remote control.

- ✓ The LED indicates the current volume setting.

- ✓ The volume has been set.



## Camera

An overview of camera settings and controls.

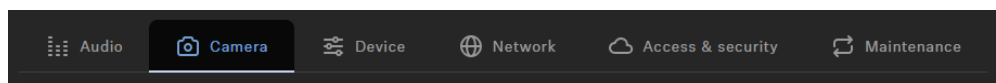

### White Balance

Adjusts the video image for natural color representation. The white balance can be set either automatically or manually.

### Brightness

Adjusts the brightness of the video image from **-12** (dark) to **12** (very bright).

### Contrast

Adjusts the contrast between light and dark parts of the video image from **1** (low contrast) to **10** (high contrast).

### Saturation

Adjusts the color saturation of the video image from **0** (low saturation) to **10** (high saturation).

### Sharpness

Adjusts the level of detail in the video image.

### Lowlight Compensation

Increases the camera sensitivity in scenes with low lighting. Either Backlight Compensation or Lowlight Compensation can be used.

### Antiflicker Frequency

Reduces image flickering caused by AC driven lighting sources.

### Autoframe Speed

Controls the speed of automatic zooming.

### Zoom Speed

Controls the speed of manual zooming.



## Pan and Tilt Speed

Controls the pan and tilt speed of the camera.

## Remote Button Control Config

Activates or deactivates functions Auto Framing and/or Person Tiling on the remote control.

## Creating a user-defined device profile

You can create a user-defined profile using .

You can adjust the individual camera settings in the device profile **Custom**. You can configure the following settings for the camera:

- **Zoom speed:**
  - Regulates the speed of the automatic zoom in a video image.
- **Auto frame speed:**
  - Regulates the switching speed of the windows between the participating areas.
- **Backlight compensation:**
  - Increases the camera's exposure in the event of backlighting. Either the backlight compensation or the lowlight compensation function can be used.
- **Exposure:**
  - Adapts the camera to scenes with different lighting conditions. The exposure can be set automatically or manually.
- **Lowlight compensation:**
  - Increases the camera's sensitivity for scenes with low lighting. Either the backlight compensation or the lowlight compensation function can be used.
- **Sharpness:**
  - Adjusts the level of detail in the video image.
- **White balance:**
  - Adapts the video image so the colors are portrayed naturally. The white balance can be set either automatically or manually.
- **Saturation:**
  - Adapts the color saturation of the video image from 0 (low saturation) to 10 (high saturation).
- **Contrast:**
  - Adapts the contrast between the light and dark parts of the video image from 1 (low contrast) to 10 (high contrast).
- **Brightness:**
  - Adjusts the brightness of the video image from -12 (dark) to 12 (very bright).

**i** When the device profile is changed, the camera settings are reset, and the device is rebooted.



**To configure the camera:**

- ▶ In , navigate to **Camera**.
- ▶ Adjust the settings for the camera in the corresponding windows.

✓ The user-defined device profile has been created.

## Setting the white balance

The white balance adapts the video image so the colors are portrayed naturally.

The white balance can be set either automatically or manually between 2800 K and 6500 K.

**To set the white balance automatically:**

- ▶ In , navigate to **Camera**.
- ▶ In the field **White Balance**, activate the button **Auto**.
- ✓ The white balance is set automatically.

**To set the white balance manually:**

- ▶ In , navigate to **Camera**.
- ▶ In the field **White Balance**, deactivate the button **Auto**.
- ▶ Set the value you want between 2800 K and 6500 K.

✓ The white balance has been set.



## Setting brightness

This setting adjusts the brightness of the video image.

The brightness can be adjusted manually within a range of -12 to 12.

### To adjust the brightness:

- ▶ In , navigate to **Camera**.
- ▶ Set the value you want from -12 (dark) to 12 (very bright) in the **Brightness** field.

✓ The brightness has been set.



## Setting contrast

This setting adjusts the contrast between the light and dark parts of the video image.

The contrast can be set manually from 1 (low contrast) to 10 (high contrast).

### To set the contrast:

- ▶ In , navigate to **Camera**.
- ▶ In the **Contrast** field, set the value you want from 1 (low contrast) to 10 (high contrast).

✓ The contrast has been set.



## Setting saturation

This setting adjusts the saturation of the video image.

The saturation can be set from 0 (no change) to 10 (high saturation).

### To set the saturation:

- ▶ In , navigate to **Camera**.
- ▶ In the **Saturation** field, set the value you want from 0 (no change) to 10 (high saturation).

✓ The saturation has been set.



## Setting sharpness

This setting adjusts the sharpness of the video image.

The sharpness can be set from 0 (no change) to 6 (very sharp).

### To set the saturation:

- ▶ In , navigate to **Camera**.
- ▶ In the **Sharpness** field, set the value you want from 0 (no change) to 6 (very sharp).

✓ The sharpness has been set.



## Activating lowlight compensation

Lowlight compensation increases the camera's sensitivity for scenes with insufficient lighting.

Either the backlight compensation or the lowlight compensation function can be used.

### To activate the lowlight compensation function:

- ▶ In , navigate to **Camera**.
- ▶ Activate the function in the field **Lowlight Compensation**.

✓ Lowlight compensation has been activated.



## Activating backlight compensation

Backlight compensation increases the camera's exposure in the event of backlight.

Either the backlight compensation or the lowlight compensation function can be used.

### To activate backlight compensation:

- ▶ In , navigate to **Camera**.
- ▶ Activate the function in the field **Backlight Compensation**.

✓ Backlight compensation has been activated.



## Setting the anti-flicker frequency

The anti-flicker frequency reduces flickering in the image that is caused by sources of light powered by alternating current.

The following settings can be selected:

- Off
- Automatic
- 50 Hz
- 60 Hz

### To set the anti-flicker frequency:

- ▶ In , navigate to **Camera**.
- ▶ Select the desired setting in the drop-down menu.

✓ The anti-flicker frequency has been set.



## Setting the auto frame speed

The auto frame speed controls the speed of the automatic zoom.

The following settings can be selected:

- Slow
- Medium
- Fast

### To set the auto frame speed:

- ▶ In , navigate to **Camera**.
- ▶ Select the desired setting in the drop-down menu.

✓ The auto frame speed has been set.



## Setting the zoom speed

The zoom speed controls the speed of the manual zoom.

The following settings can be selected:

- Slow
- Medium
- Fast

### To set the zoom speed:

- ▶ In , navigate to **Camera**.
- ▶ Select the desired setting in the drop-down menu.

✓ The zoom speed has been set.



## Setting the panning and tilting speed

The panning and tilting speed controls the speed at which the camera pans and tilts.

The following settings can be selected:

- Slow
- Medium
- Fast

### To set the panning and tilting speed:

- ▶ In , navigate to **Camera**.
- ▶ Select the desired setting in the drop-down menu.

✓ The panning and tilting speed has been set.



## Activating the functions for remote control

Activate the auto framing and person tiling functions so you can use them conveniently via remote control.

You can activate and deactivate the auto framing and person tiling functions via remote control only after activating this function.

### To activate the functions for remote control:

- ▶ In , navigate to **Camera**.
- ▶ In the field **Remote Button Control Config**, activate the desired function in order to be able to call it up via remote control.

✓ The functions were activated for remote control.



## Enabling auto framing

The **Auto framing** function focuses on participating people in the room and guarantees this focus at all times.

- i** The **Auto Framing** function can be activated and deactivated only by remote control. For this to be possible, the output function for remote control must be activated using (see [Activating the functions for remote control](#)).

### To activate auto framing:

- ▶ Briefly press the **Auto Framing** button on the remote control.
- ✓ The camera LED switches to the following display:

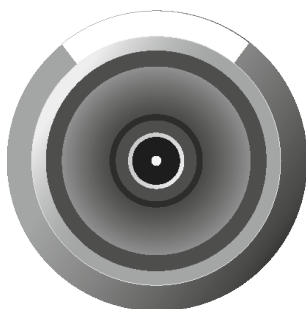

- ✓ Auto framing has been activated.



## Enabling person tiling

The **Person tiling** function records all participating people in the room during a conference and provides the video signal in a form that is suitable for the far end.

- i** The **Person Tiling** function can be activated and deactivated only by remote control. For this to be possible, the output function for remote control must be activated using the (see [Activating the functions for remote control](#)).

### To enable person tiling:

- ▶ Briefly press the **Person Tiling** button on the remote control.
- ✓ The camera LED switches to the following display:

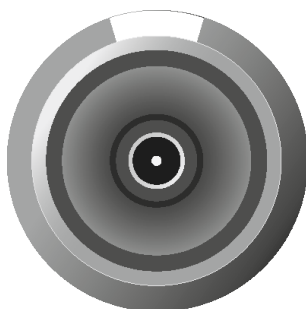

- ✓ Person tiling has been enabled.



## Setting default camera mode

Set a persistent default camera mode so the device always starts in the selected mode, ensuring a consistent experience without manual adjustments, even after a reboot or wake-up.

You can configure a persistent default camera mode, which will be applied before starting a call. During an active call, you can change the camera mode temporarily using the IR remote. These changes apply only to the current session and do not modify the configured default.

After the call ends or the device restarts, the system reverts to the stored default camera mode.

### To set up a default camera mode:

- ▶ In , navigate to **Camera**.
- ▶ Click the drop-down list under **Default Camera Mode**.
- ▶ Choose between the displayed modes:
  - **Resume Last View (Default)**: In this mode, the last saved changes will be applied.
  - **Full Field of View**: Displays the entire field of view.
  - **Auto Framing**: Focuses on participants in the room and maintains this focus at all times.
  - **Person Tiling**: Automatically divides recorded participants into individually tailored frames.
  - **User Preset**: All user configured camera settings will be applied.

✓ The default camera mode has been set.



## Device

An overview of the device's key features and specifications.

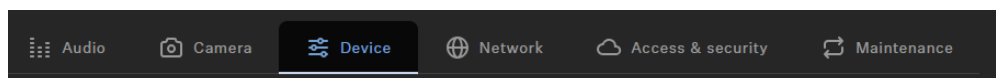

### LED Brightness

Slider for adjusting the LED brightness.

- **Off:** the LEDs are switched off completely
- **1 ... 5:** adjusts the brightness between low (1) and high (5)

### Sound Prompts

Activates or deactivates all integrated sounds of the TC Bar with the exception of the welcome prompt.

### HDMI output

Activates the HDMI output signal to external display.

- i** If you select "Microsoft Teams" as the "Device Profile", the HDMI output is deactivated.

### Device Profile

Here you can select the desired device profile, which is applied either from your own configured settings or from the predefined settings of the selected conference and collaboration platform.

- i** When changing the device profile, the camera settings will be reset and the device will be restarted.

- **Custom:** own device profile
  - Enables all settings in the **Camera** tab as well as the HDMI output in the **Device** tab
- **Microsoft Teams:** predefined by Microsoft Teams



**i** Using this profile, the camera zoom of the TC Bar is reduced to comply with Microsoft Teams specification.

- Enables the default settings for Microsoft Teams
- Resets all settings in the **Camera** tab
- Disables the HDMI output in the **Device** tab
- Reboots the device
- **Zoom:** predefined by Zoom

**i** Using this profile, the camera zoom of the TC Bar might be changed to comply with Zoom specification.

- Enables the default settings for Zoom
- Resets all settings in the **Camera** tab
- Reboots the device

## Updating the firmware

When the PC running is connected to the Internet, the most recent firmware versions for all update-able devices is automatically made available.

**i** In order to use the latest features of the software and in order for all devices to work properly, we strongly recommend keeping the firmware of all devices up to date.

**i** For security reasons, firmware (FW) updates are not backward compatible; therefore, FW versions older than the currently installed version cannot be uploaded.

### ATTENTION



#### Loss of data if the firmware transfer is interrupted

If the transfer is interrupted, this may lead to a loss of data. The devices may be damaged by this.

- ▶ Do not remove any connections to the stationary devices during firmware updates.

- ▶ In , navigate to the start page.
- ✓ The Firmware Info dialog indicates the available firmware versions.



- ▶ From the drop-down list, select the firmware version you want to install.

**i** To add manually downloaded firmware, click on Add firmware file and select the downloaded file. Firmware versions downloaded automatically by are marked **via update server**. Firmware versions downloaded manually by yourself are marked **added manually**.

- ▶ Click on **Update**.
  - ✓ The firmware of the TC Bar is updated. Afterwards, the device reboots. The LED display presents a short demo.

✓ The firmware has been successfully updated.



## Setting LED brightness

This setting adjusts the brightness of the LEDs on the TC Bar.

The brightness can be set from 0 (off) to 5 (very bright).

### To set the LED brightness:

- ▶ In , navigate to **Device**.
- ▶ Set the value you want from 0 (off) to 5 (very bright) in the **LED Brightness** field.

✓ The LED brightness has been set.



## Stipulating a device profile for the camera

Device profiles contain custom or predefined settings for supported conference and collaboration platforms.

- **Custom:** Activates all the settings on the **Camera** tab and the HDMI® output on the **Device** tab.
- **Microsoft Teams:**
  - Activates the standard settings for Microsoft Teams.
  - Resets all settings on the **Camera** tab.
  - Deactivates the HDMI® output on the **Device** tab.
  - Restarts the device.

**i** This profile reduces the camera zoom of the TC Bar in order to fulfill the specifications of Microsoft Teams.

- **Zoom**
  - Activates the standard settings for Zoom.
  - Resets all settings on the **Camera** tab.
  - Restarts the device.

**i** This profile reduces the camera zoom of the TC Bar in order to fulfill the specifications of Zoom.

### To select the device profile for the camera:

**i** When the device profile is changed, the camera settings are reset, and the device is rebooted.

- ▶ In , navigate to **Camera**.
- ▶ Select the desired profile under **Device Profiles**.

✓ The device profile for the camera has been defined.



## De-/activating sound prompts

This function activates or deactivates the integrated sounds when the device is turned on and off and when the TC Bar is connected to or disconnected from other devices.

### To de-/activate sound prompts:

- ▶ In , navigate to **Device**.
- ▶ Activate or deactivate the function under **Sound Prompts**.

✓ Sound prompts were de-/activated.



## Rebooting the TC Bar

You can configure the TC Bar using the control panel in Sennheiser's control software.

**i** When the TC Bar is rebooted, all active connections are interrupted.

### To reboot the TC Bar:

- ▶ In , navigate to **Device**.
- ▶ Slide the control under **Device Restart** to the right and click **OK**.

✓ The device is rebooted.

**i** The TC Bar is also rebooted as soon as a device profile for the camera is activated in .



## Activating the HDMI® output

You can activate the HDMI® output in order to transmit video signals to external screens.

**i** Please note that the HDMI® output is always deactivated when the device profile **Microsoft Teams** is used.

### To activate the HDMI® output:

- ▶ Make sure the most recent version of the driver for DisplayLink® is installed on your connected device. You can find the most recent version on the website [DisplayLink®](#).
- ▶ In , navigate to **Device**.
- ▶ Under **HDMI® Output**, click the switch **Deactivated**.
  - ✓ The switch changes to the status **Activated**.

✓ The HDMI® output has been activated.



## Changing energy-saving mode

Adjust the device's power-saving mode according to your requirements.

You can adjust the energy-saving mode according to your infrastructure and the required use cases. Select the appropriate mode for this:

- (default)
- (optional)
- (optional)

### CAUTION



#### Increased power consumption in Always On Mode

Enabling **Always On Mode** will increase the device's power consumption. This mode bypasses energy-saving functions and keeps the device fully active at all times.

- ▶ Enable this mode only if the device must be available 24/7 for remote access.

#### To change the energy saving mode:

- ▶ In , navigate to **Device**.
- ▶ Select the mode under **Energy Saving Mode**.
- ▶ If Always On Mode was selected, confirm the message that you have been informed about the device's increased power consumption.

✓ The energy saving mode has been changed.



## Network

The following network settings are available for the TC Bar.

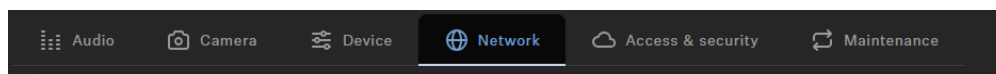

### Network Mode

Displays the Dante® Network port configuration of the selected device.

- Single Domain Mode (default mode for TC Bar and TC Bar M):
- Dual Domain Mode (for TC Bar S and TC Bar M)
- Split mode (only for TC Bar M)

#### Single Domain Mode:

- This mode is usually used if you want to use both the controller (Sennheiser or third-party provider) and Dante® on the same physical port with only one available IP in the same network. To set up both configurations, you need the Sennheiser Control Cockpit for the control network and the Dante Controller for other routed Sennheiser devices.

#### Dual Domain Mode:

- This mode is generally used if you receive a merged flow from two separate networks via a single network line and you want to resolve this merged flow back into two different IP and MAC addresses. In this way you can operate the Dante® network and the control network independently of each other via the same switch.
- Outgoing Dante® data packets are tagged as a VLAN (Virtual Local Area Network) in accordance with the 802.1q standard. The incoming data packets must also be tagged by the externally connected network in order to be able to assign them correctly for internal use. Depending on the device, the data packets may need to be translated from the outgoing 802.1q standard to 802.3 via a managed switch.

#### Split Mode:

- This mode is generally used if you receive a mixed signal from two separate networks via a single network line and want to resolve this mixed signal back into two different IP addresses. In this way, you want to operate the Dante network and the control network independently of each other and use a separate switch for each network.

### DANTE Protocols

Enables a digital audio network protocol over Ethernet for routing and synchronization of Dante-compatible devices using the Dante Controller software.



## Control/Dante Settings IPv4

### IP Mode

- **Automatic:** The IP address is automatically assigned using DHCP. If no DHCP server is available, the IP address is assigned by the SL Rack Receiver DW itself.
- **Fixed IP:** The IP address has to be entered manually.

### mDNS

- **Off:** Deactivates mDNS to reduce the data volume transferred across the network. This option is recommended for larger systems.
- **On:** Activates mDNS to allow for automatic device detection. This option is recommended for smaller systems with up to 30 devices.

### IP

- Input of the IP address in Fixed IP mode.

### Subnet

- Input of the subnet mask in Fixed IP mode.

### Gateway

- Input of the gateway in Fixed IP mode.

### DNS Server

Configure DNS servers for hostname resolution. When using a fixed IP configuration, it is essential to define at least one DNS server to ensure proper network functionality, including cloud connectivity.

Modes:

- **Automatic:** The DNS server is assigned automatically.
- **Manual:** The DNS server is assigned manually by entering the server name.

### MAC Address

Displays the unique MAC addresses of the device according to the connected ports.



## Bluetooth®

Bluetooth is deactivated by default. In order to activate BT and connect the TC Bar to a BT-compatible device:

- Click on **Enabled** to activate the BT function and wait approx. 10 sec in order to let the device process the initial activation.
- Click on **Start** to start the pairing process.
- In your device, search for your TC Bar name and click on **Connect**. If the TC Bar is not yet visible, repeat the pairing process again.

**i** Devices that have already been paired are displayed under **Known Devices**.

## Activating tagged VLAN (Dante® network)

A VLAN (virtual local area network) separates a physical network into partial networks. As a result, you can set up several virtual networks from a physically existent switch port (such as the Dante® network and control network).

The TC Bar supports the prioritizing technology **tagged VLAN** as per IEEE 802.1Q. Thus, for example, when the TC Bar S is used with only a network connection, the Dante® network and the control network can be separated virtually and operated independently. In the process, the frames for the Dante® network receive a tag (marking) that contains the VLAN ID. That is how the switch port receives information about the Dante® VLAN to which the frame belongs.

**i** When the TC Bar M is used, the Dante® network and control network can be operated independently of one another via the two existing network ports. To do this, select the network mode **Split Mode**.

### To activate tagged VLAN for a Dante® network:

- ▶ In , navigate to **Network**.
- ▶ In the **Network Mode** window, select the mode **Dual Domain Mode**.
- ▶ In the **Dante® Settings** window, click **Edit**.
- ▶ In the field **VLAN ID**, enter the correct ID in order to be routed to the correct network.
- ▶ Click **OK** to save the changes.

✓ Tagged VLAN has been activated.



## Activating Bluetooth®

When the device is delivered, Bluetooth® is deactivated and can be activated in .

- i** Please note that after the Bluetooth® function is activated, the Bluetooth® pairing process must be started in order to create a connection (see [Starting Bluetooth® pairing](#)).

### To activate Bluetooth®:

- ▶ In , navigate to **Network**.
- ▶ Under **Bluetooth**, activate the Bluetooth® switch and wait approximately 10 seconds for the operating system to activate the function.
  - ✓ The Bluetooth® function has been activated.

- ✓ You can now begin the Bluetooth® pairing process (see [Starting Bluetooth® pairing](#)).



## Starting Bluetooth® pairing

The pairing process can be started using the Bluetooth® button.

- i** Please note that Bluetooth® is deactivated in the factory settings. To create a Bluetooth® connection with a device that is capable of Bluetooth®, you must activate the Bluetooth® function in and then start the pairing process ([Activating Bluetooth®](#)).

There are several ways to start the Bluetooth® pairing process:

- Using the
- Using the initialization button on the TC Bar
- Using the remote control

### To start Bluetooth® pairing in :

- ▶ Navigate to **Network**.
- ▶ Under **Bluetooth®**, click the switch **Start**.
  - ✓ The blue LED flashes. Bluetooth pairing is activated. The device is in pairing mode and can be connected to a device that is capable of Bluetooth.



### To start Bluetooth® pairing via the TC Bar:

- ▶ Press the Bluetooth® pairing button on the left side of the TC Bar for at least three seconds.
  - ✓ The blue LED flashes. Bluetooth pairing is activated. The device is in pairing mode and can be connected to a device that is capable of Bluetooth.



**To start Bluetooth® pairing via the remote control:**

- ▶ Press the Bluetooth® pairing button on the remote control for at least three seconds.

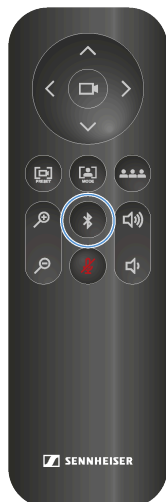

- ✓ The blue LED flashes. Bluetooth pairing is activated. The device is in pairing mode and can be connected to a device that is capable of Bluetooth.

✓ Bluetooth® pairing has begun. You can now couple the TC Bar with a device that is capable of Bluetooth® .



## Activating Dante® signal forwarding

Using the Dante controller software, you can activate a digital audio network protocol via Ethernet for the routing and a synchronization of Dante®-compatible devices.

**i** Please note that the audio signal via Dante® is not encrypted!

To route additional Sennheiser Audio devices to the TC Bar, the following steps must be performed:

- Activating the Dante® protocol in
- Forwarding the audio signals in the Dante controller

### To activate the Dante® protocol:

- ▶ In , navigate to **Network**.
- ▶ Activate the slider in the field **Dante® protocols**.
  - ✓ The Dante® protocol was activated.

### To route TCC M signals to the TC Bar, for example

- ▶ Guide the **FarEndOut** from the TCC M to **ExternalMicIn1** of the TC Bar (or **ExternalMicIn2**).
- ▶ Guide the **FarEndRefOut** of the TC Bar to the **FarEndRef** of the TCC M.

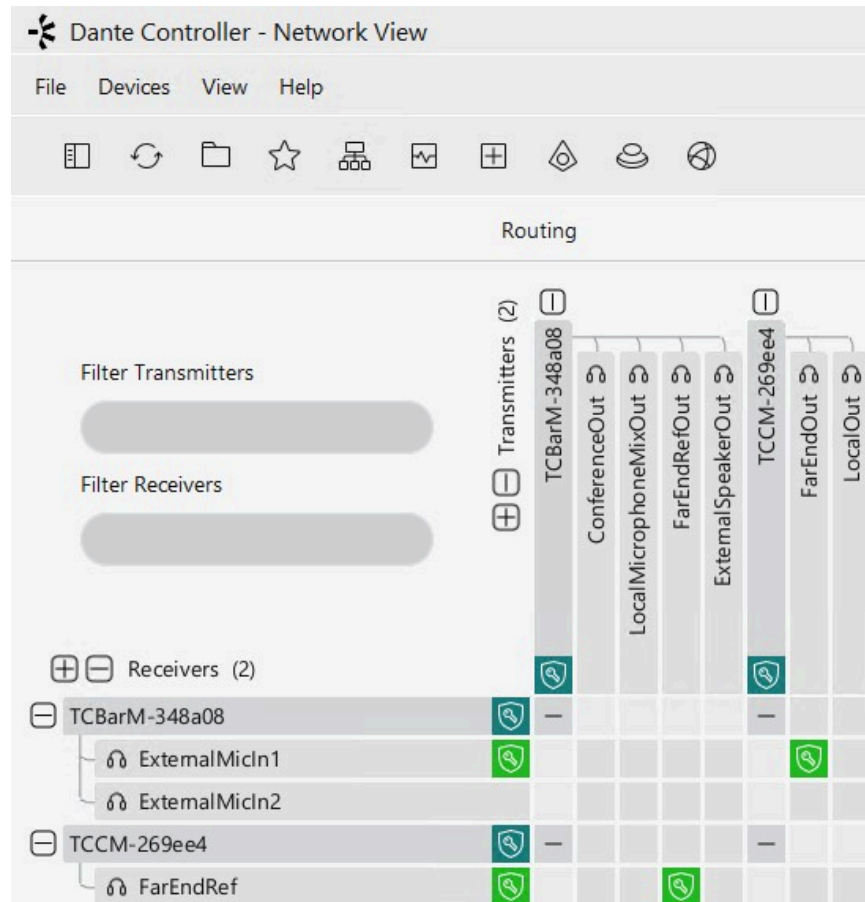

**i** We strongly recommend using the beam freeze function of the TCC M microphone. Our tests have shown that the TC Bar's echo suppression is far better when the beam freeze function is used.

✓ Forwarding AV signals via the Dante controller has been activated.



## Activating the continuous Dante® stream

This function enables the continuous transmission of microphone streams over Dante®.

- i** Audio data will be streamed permanently over Dante®. This may increase power consumption. Ensure that continuous audio streaming over Dante® complies with your regional security and regulatory requirements before enabling.

### CAUTION



#### Risk from unencrypted audio communication

Communication over Dante® is not encrypted by default and can be eavesdropped on and misused by 3<sup>rd</sup> parties.

- ▶ Enable continuous transmission over Dante® only when no sensitive content is being transmitted.
- ▶ Encrypt your communication for sensitive content using [Dante Media Encryption feature](#) in [Dante Director](#).

To enable the continuous Dante® stream:

- ▶ In , navigate to **Network**.
- ▶ Activate the toggle in the field **Continuous Dante® Stream**.

- ✓ The continuous Dante® stream has been activated.



## Selecting a network mode

You can configure the various network modes using the panel in Sennheiser's control software.

**The TC Bars are in the following network modes in the factory settings:**

- TC Bar S: Single domain mode
- TC Bar M: Split mode

**To select a network mode:**

- ▶ In , navigate to **Network**.
- ▶ Select a network mode from among the following options:
  - Single domain mode
  - Dual domain mode
  - Split mode (only for TC Bar M)

✓ The network mode has been selected.



## Access & Security

Overview of access and security features.

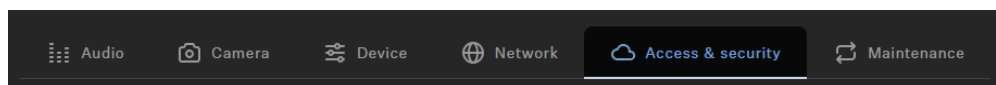

### Sennheiser DeviceHub

Enable this feature to prepare the device rollout to DeviceHub. For more information, see:

- DeviceHub
- Roll out device to DeviceHub

### Device Access

Changes the password for device access, used by Control Cockpit to authenticate to the device.

**i** Please note that the new password must meet the following requirements:

- At least ten characters
- At least one lowercase letter
- At least one uppercase letter
- At least one number
- At least one special character: !#\$%&()\*+,-./:;<=>@[^\_{}~
- Maximum length: 64 characters

### Third-Party Access

The 3rd party media control access for TeamConnect Bar is encrypted and protected using username and password. It has to be enabled using Control Cockpit before use.

**i** The full range of functions and list of callable methods can be found in the media control protocol for the TeamConnect Bar ([see 3rd party for TeamConnect Bar](#)).

- Enables or disables 3rd party media control access. In order to enable, select the **Edit** button, activate the toggle switch, enter a 3rd party device password and select the **OK** button.
- You can use the username **api** and configured password for your API calls.

**i** If you deactivate 3rd party access, the previously set password will be deleted.



**i** Please note that the new password must meet the following requirements:

- At least ten characters
- At least one lowercase letter
- At least one uppercase letter
- At least one number
- At least one special character: !#\$%&()\*+,-./:;<=>@[ ]^\_{}~
- Maximum length: 64 characters

## Activating third-party access

You can activate third-party media control in if you want the TC Bar to be operated via an API.

**To activate third-party access:**

- ▶ In , navigate to **Access & security**.
- ▶ In the field **3rd Party Access**, click **Edit**.
- ▶ In the field **Access**, set the switch to **Activated**.
- ▶ Assign an access password, which is requested by a media control system during device authentication.

**i** Please note that the new password must meet the following requirements:

- At least ten characters
- One lowercase letter (a...z)
- One uppercase letter (A...Z)
- One number (0...9)
- One special character (!#\$%&()\*+,-./:;<=>@[ ]^\_{}~)
- Maximum length: 64 characters

- ▶ Click **OK** to save the settings.

✓ Third-party access has been activated.



## Activating device access

You can change the password for accessing the device.

### To change the password for accessing the device:

- ▶ In , navigate to **Access & security**.
- ▶ In the field **Device Access**, click **Edit**.
- ▶ Assign an access password, which is queried during instance claiming in LUI (see [Running Local Web UI \(LUI\)](#)).

**i** Please note that the new password must meet the following requirements:

- At least ten characters
- One lowercase letter (a...z)
- One uppercase letter (A...Z)
- One number (0...9)
- One special character (!#\$%&()\*+,- ./:;<=>@[ ]^\_{}~)
- Maximum length: 64 characters

- ▶ Click **OK** to save the settings.

✓ The password for device access was changed.



## Maintenance

In this section, you will find the maintenance procedures, along with instructions for configuring NTP servers and managing time synchronization settings on the device.

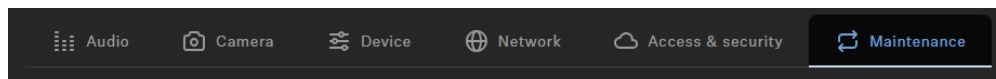

### NTP servers

Enable or disable automatic time synchronization via NTP. Choose between Automatic and Manual mode. In Manual mode, you can specify up to two NTP server addresses.

### System Time

Shows the current system time the device is operating with. If NTP is disabled, you can set the system time here.

### Audio Default Settings

Resets the audio settings (Low Cut and Sound Profiles) to the factory defaults.

**i** The last status saved in the “Location-based mute” field is retained even after you reset the audio settings to the factory defaults.

### Camera Reset

Resets the preset camera settings to default settings.

### Factory Reset

All settings of the selected device are reset to the factory defaults.

**i** The last saved status of the **Location-based mute** function is retained even after you reset the device to the factory default.

## Resetting the audio settings

You can reset all audio settings to the factory settings.



**To reset all audio settings:**

- ▶ In , navigate to **Audio > Audio Setup**.
- ▶ Slide the controller for **Audio Default Settings** to the right and confirm it with **OK**.

✓ All audio settings were reset to the factory settings.



## Resetting camera settings

You can reset all camera settings to the factory settings.

### To reset all camera settings:

- ▶ In , navigate to **Camera**.
- ▶ Slide the controller for **Camera Reset** to the right and confirm with **OK**.

✓ All camera settings were reset to the factory settings.



## Resetting the TC Bar to factory settings

You can reset the device to the factory settings manually by pressing the button on the back of the device or remotely using the control panel in .

### ATTENTION



#### Loss of data after resetting to factory settings

All active connections are interrupted, and all settings are reset to the factory settings.

All the personal data that the internal memory had recorded is irrevocably deleted.

- ▶ Make sure that no connections are being actively used at the time of the reset.
- ▶ Check whether all relevant personal data has been properly deleted.

- ▶ Reset the TC Bar to the factory settings by either:

- Holding down the reset button on the back of the device at least 7 seconds,

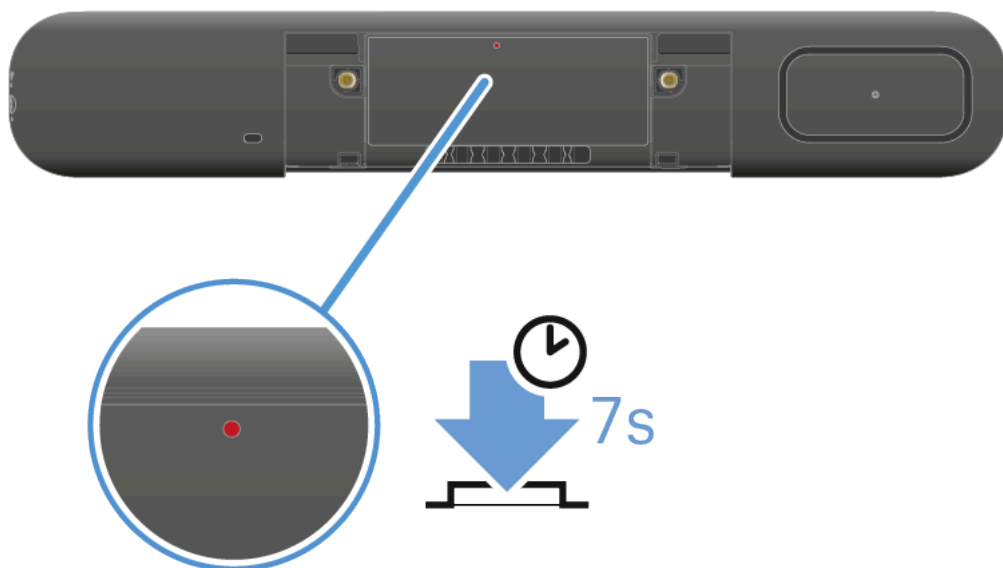

or

- In , navigate to **Maintenance**, and under **Factory Reset** slide the slider to the right. Confirm the setting with **OK**.
- ✓ There is a brief sound, and the red LED slowly flashes. The TC bar is reset and then rebooted. The white LED flashes during the boot process. A short melody sounds when the device is ready for operation.



✓ The TC Bar has been reset and is ready for operation.



## Control Cockpit

### Overview

Control Cockpit is a centralized management interface that streamlines the operation and monitoring of audio, video, and control systems from a single user-friendly dashboard.

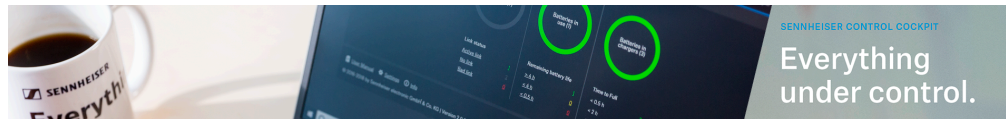

With Control Cockpit users can easily manage device settings, monitor system performance, and execute commands across multiple devices from one location.

- i** For more details, please visit the website [sennheiser.com/control-cockpit](https://sennheiser.com/control-cockpit) or the online manual under [Control Cockpit](#).

**Control Cockpit supports the following functions for the TC Bar:**

### Initial configuration

- [Claiming the TC Bar for a specific Control Cockpit instance \(network solution\)](#)
- [Manually adding the TC Bar to the Control Cockpit](#)
- [Selecting a sound profile](#)
- [Stipulating a device profile for the camera](#)
- [Selecting a network mode](#)

### Audio

- [Selecting a sound profile](#)
- [Setting the internal microphone noise gate](#)
- [Handling auto mix priority](#)
- [Configuring fade time](#)
- [Adapting far end output for TCC M](#)
- [Setting the volume](#)
- [Muting internal TC Bar microphone](#)
- [Muting all microphones](#)
- [Enabling Dante® speaker output](#)
- [Activating location-based mute](#)
- [Resetting the audio settings](#)

### Zones

- [Creating a priority zone](#)
- [Configuring exclusion zones](#)



## Device

- Updating the firmware
- Setting LED brightness
- Stipulating a device profile for the camera
- De-/activating sound prompts
- Rebooting the TC Bar
- Activating the HDMI® output
- Changing energy-saving mode
- Resetting the TC Bar to factory settings

## Network

- Activating tagged VLAN (Dante® network)
- Activating Bluetooth®
- Starting Bluetooth® pairing
- Pairing the TC Bar with a Bluetooth® device
- Activating Dante® signal forwarding
- Activating the continuous Dante® stream
- Selecting a network mode

## Camera

- Creating a user-defined device profile
- Setting the white balance
- Setting brightness
- Setting contrast
- Setting saturation
- Setting sharpness
- Activating lowlight compensation
- Activating backlight compensation
- Setting the anti-flicker frequency
- Setting the auto frame speed
- Setting the zoom speed
- Setting the panning and tilting speed
- Activating the functions for remote control
- Enabling auto framing
- Enabling person tiling
- Setting the camera position
- Connecting an external PTZ camera
- Setting default camera mode
- Resetting camera settings

## Access

- Activating third-party access
- Activating device access



## Initial configuration

This section guides you step by step through the initial configuration using tried-and-trusted methods and procedures.

Additional settings allow you to adapt the TC Bar to the requirements of your existing infrastructure.

**To begin with, we recommend configuring the following for your TC Bar:**

- [Claiming the TC Bar for a specific Control Cockpit instance \(network solution\)](#)
- [Selecting a sound profile](#)
- [Stipulating a device profile for the camera](#)
- [Selecting a network mode](#)

**We then recommend configuring the following enhanced settings in the Control Cockpit as needed:**

- [Activating Dante® signal forwarding](#)
- [Activating tagged VLAN \(Dante® network\)](#)
- [Handling auto mix priority](#)
- [Setting the internal microphone noise gate](#)
- [Adapting far end output for TCC M](#)
- [Creating a priority zone](#)
- [Configuring exclusion zones](#)

You can find all additional available functions and settings under [Usage](#).

## Claiming the TC Bar for a specific Control Cockpit instance (network solution)

The TC Bar is delivered with password protection for the configuration. This device must be claimed by a Control Cockpit instance before you can view and modify its configuration.

**i** Please note that the device must be claimed before its full range of functions is available (see [Operation as a networked conference system](#)).

Registering the device serves to link the device to the Control Cockpit and thus prevent the device from being controlled over the network without authentication. The device is controlled by means of encrypted communication and only with the password you have set.

**i** To set up the device's initial configuration, you have to connect directly to the network via the LAN cable (RJ45).



**i** Use only network cables with the standard CAT5e (F/STP) or better.

**To assign the TC Bar to a Control Cockpit instance:**

- ▶ Download the Sennheiser Control Cockpit software [sennheiser.com/control-cockpit](https://sennheiser.com/control-cockpit) and install the application on a PC/server.
- ▶ Connect the device's control network port to the network.
- ▶ Open the Control Cockpit and click on the view **Device List**.
- ✓ The new unclaimed device is automatically detected.

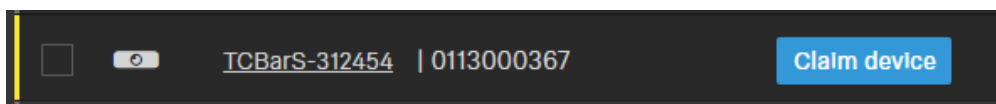

If the device is not displayed in the device list, carry out the following steps:

After a minute has elapsed, update the Cockpit using the switch **Refresh list**.

Add the TC Bar manually by entering an IP address (see [Manually adding the TC Bar to the Control Cockpit](#)).

- ▶ Click **Claim device** and enter the device's default password.

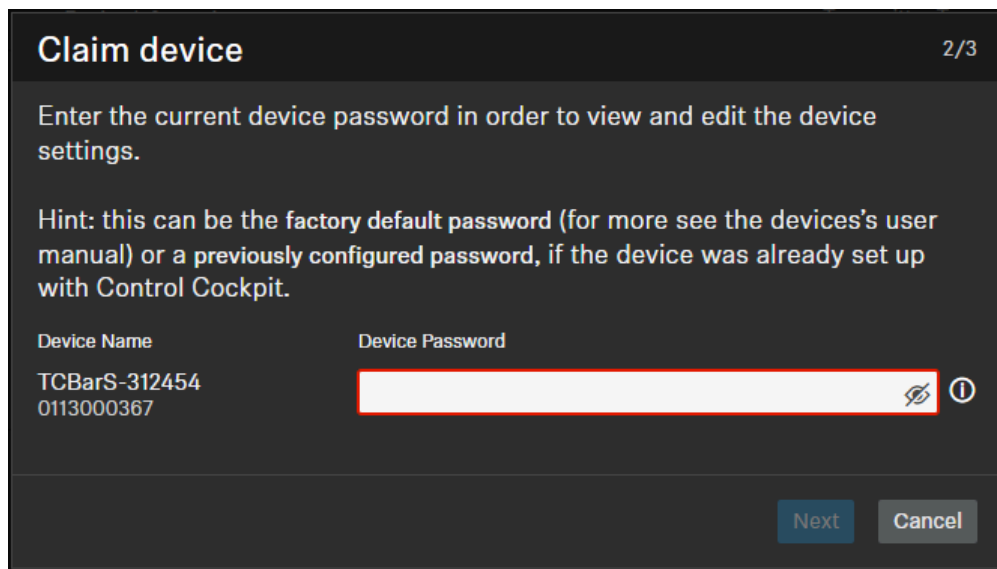

**i** You can find the default password on the type plate of the device under **Default PW**.



**i** If the device has been previously claimed by another instance of Control Cockpit, enter the password set previously. If you do not remember the password set previously, reset the device to its factory settings (see [Resetting the TC Bar to factory settings](#)) and enter the default password again.

✓ To ensure secure access to the device, you will immediately be prompted to enter a new password.

**Claim device** 3/3

Please enter a new password for this (these) device(s).

Please remember this password as it will be needed in case the device is to be claimed again in the future. It cannot be displayed in the application.

The new password has to be at least 10 characters long and contain at least one of each: lowercase letter (a..z), uppercase letter (A..Z), digit (0..9), special character.

New Password

Back Set Password Cancel

**i** Please note that the new password must meet the following requirements:

- At least ten characters
- One lowercase letter (a...z)
- One uppercase letter (A...Z)
- One number (0...9)
- One special character (!#\$%&()\*+,- ./:;<=>@[ ]^\_{|}~)
- Maximum length: 64 characters

▶ Enter the new password for your device and click **Set Password**.

**i** You can change the device password on the **Access** tab on the device page [Activating device access](#). You can also install a new instance of Control Cockpit and claim the device by entering the set device password.



✓ The device has now been claimed by a Control Cockpit instance. You can now use all available functions. You can find more information at [sennheiser.com/control-cockpit](https://sennheiser.com/control-cockpit).

## Manually adding the TC Bar to the Control Cockpit

If the Control Cockpit does not automatically detect the TC Bar, you can add it manually using an IP.

### To add the TC Bar to the list of devices in the Sennheiser Control Cockpit:

- ▶ On the **Devices** tab in the Control Cockpit, click **Add device**.
  - ✓ A dialog window with additional input fields appears.
- ▶ Enter the IP address of the TC Bar. Alternatively, you can also enter an address range to add several devices at the same time.
- ▶ Then click **Save**.

✓ The TC Bar was successfully added. If the TC Bar is still not visible, refresh the web interface of the Control Cockpit using the switch **Refresh list**.



## Selecting a sound profile

Sound profiles are presets that are optimized for the intended mounting options.

You can either select a profile (recommended) or manually adjust the equalizer setting.

- ▶ In the Control Cockpit, navigate to **Devices > TC Bar > Audio**.
- ▶ Select the installed mounting type from the drop-down list (recommended). Optional: Select **Custom** to configure your own settings.

✓ The sound profile for your TC Bar has been selected.



## Stipulating a device profile for the camera

Device profiles contain custom or predefined settings for supported conference and collaboration platforms.

- **Custom:** Activates all the settings on the **Camera** tab and the HDMI output on the **Device** tab.
- **Microsoft Teams:**
  - Activates the standard settings for Microsoft Teams.
  - Resets all settings on the **Camera** tab.
  - Deactivates the HDMI output on the **Device** tab.
  - Restarts the device.

**i** This profile reduces the camera zoom of the TC Bar in order to fulfill the specifications of Microsoft Teams.

- **Zoom**
  - Activates the standard settings for Zoom.
  - Resets all settings on the **Camera** tab.
  - Restarts the device.

**i** This profile reduces the camera zoom of the TC Bar in order to fulfill the specifications of Zoom.

### To select the device profile for the camera:

**i** When the device profile is changed, the camera settings are reset, and the device is rebooted.

- ▶ In the Control Cockpit, navigate to **Devices > TC Bar > Camera**.
- ▶ Select the desired profile under **Device Profiles**.

✓ The device profile for the camera has been defined.



## Selecting a network mode

You can configure the various network modes using the panel in Sennheiser's control software.

**The TC Bars are in the following network modes in the factory settings:**

- TC Bar S: Single domain mode
- TC Bar M: Split mode

**To select a network mode:**

- ▶ In the Control Cockpit, navigate to **Devices > TC Bar > Network**.
- ▶ Select a network mode from among the following options:
  - Single domain mode
  - Dual domain mode
  - Split mode (only for TC Bar M)

✓ The network mode has been selected.



## Audio Settings

The following settings can be adjusted in the audio tab.

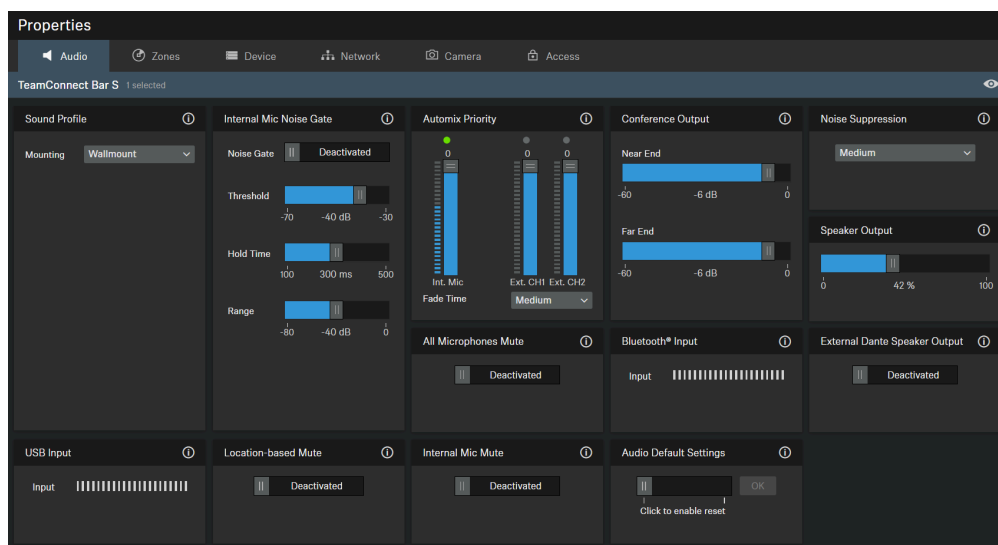

1. [Noise Suppression](#)
2. [Internal Mic Mute](#)
3. [External Dante® Speaker Output](#)

### Sound Profile

Sound profiles are presets that are optimized for the intended mounting options.

Custom: 7-band equalizer for manually adjusting or selecting preset sound settings depending on the mounting option of the device:

- Wallmount
- Table Top
- Under Display
- Above Display
- Free Standing
- Custom

### Internal Microphone Noise Gate

#### Noise Gate:

Noise Gate can be activated to avoid amplification of background noise, e.g. during pauses in speech.

#### Threshold:

The Noise Gate will open the audio of the microphone output only after the predefined threshold value of the needed microphone has been reached. With the slider you can adjust the minimum threshold level from -70 dB to -30 dB in steps of 1 dB.



### Hold Time:

The Hold Time sets the duration until the noise gate is activated, e.g. during speech pauses. With the slider you can adjust the duration time from 100 ms to 500 ms in steps of 50 ms.

### Range

The 'Range' parameter defines the degree of noise suppression below the set threshold for the entire Noise Gate. The parameter can be set in steps of 1 dB between 0 dB (no suppression) and 80 dB (the level is reduced by 80 dB below the threshold and after the 'attack time').

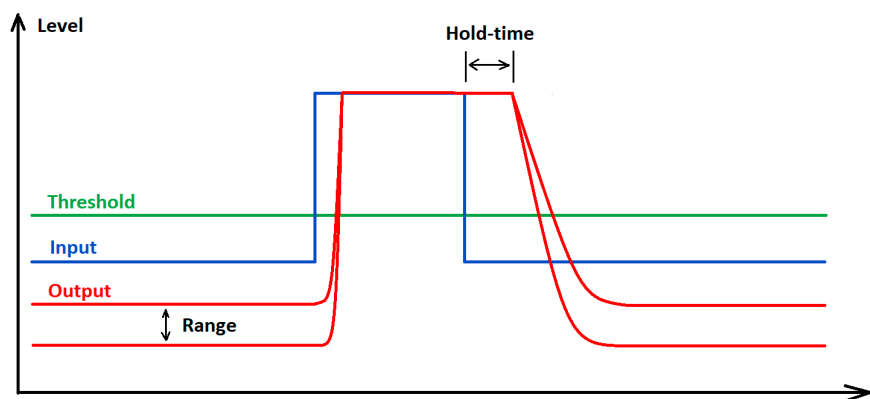

### Automix Priority

The TC Bar has up to two Dante® inputs for external microphone channels (Ext. CH 1 and Ext. CH 2). The channels allow external devices (e.g. TeamConnect Ceiling Medium) to be connected to the TC Bar via a Dante® network. The settings via the Automix Priority only manage the priority of the selected channel. It has no influence on the actual gain level of the connected microphones.

### Integrated Automixer

The Dante® inputs are managed via an integrated automixer, whereby the priority of the channels, including the internal microphone array, can be set via individual faders. Reducing the level by the corresponding control fader will add a virtual level reduction to the channel that makes it less likely to be selected by the automixer.

### Level meters

The level meters show the signal level of the inputs and the internal microphone array PRE fader and also PRE virtual level reduction. Moving the faders therefore does not change the displayed levels.

### Prioritizing a single channel

If you want to prioritize a single channel from the selection, you will have to reduce the virtual gain reduction of the other two channels. With Fade Time you can adjust the switching speed between the audio sources connected to the auto mixer.



### Active channel

The automixer provides an indicator above the channels to show the active channel. If the channel is active, the indicator changes to green. The automixer has a NOM (Number of Open Microphones) = 1, so that only one microphone can be active at a time.

### Internal Mic Mute

Mutes only the internal microphone input channel of the device. External microphone channels (Ext. CH1 and Ext. CH2) remain unaffected.

### Conference Output

Controls the level of the near and far end signals at the Dante® conference output.

Slider for adjusting the digital audio output level from 0 dB to -60 dB in steps of 1 dB.

### Noise Suppression

Noise Suppression detects and suppresses unwanted static background noise (e.g. HVAC, fans etc.). Depending on the intensity of the noise level, you can choose the degree of suppression:

- low
- medium
- high

### Speaker Output

Slider for adjusting the audio output level by up to 100 %.

### Bluetooth Input

Shows the output level of the currently connected Bluetooth device, which is fed into the TC Bar as the input level.

### External Dante® Speaker Output

Routes audio to Dante® speakers and disables the TC Bar's internal speakers.

**i** Dante® must be enabled for this function to work.

### USB Input

Shows the output level of the currently connected USB device, which is fed into the TC Bar as the input level.



### All Microphones Mute

Mutes all microphone input channels:

- Internal Mic.
- Ext. CH1
- Ext. CH2

**i** Muting the microphone can also be activated or deactivated using the system settings of the operating system and/or conference system in use (e.g., MS Teams, Zoom, etc.).

If you use the Control Cockpit to mute the microphone, all outgoing microphone signals are muted. This is the case even if your connected TCC M does not display a red LED to indicate the device is muted. Additionally, the TC Bar does not transmit any more audio signals through the Dante® channels NearEnd ConferenceOut or LocalMicrophoneMixOut. The channel FarEnd ConferenceOut continues to be transmitted.

### Location based mute

**Part of group:** Activate this function to add the transmitter to a mute group. If then one of the transmitters in this mute group is muted or unmuted, all other transmitters in the same mute group of the same location will also be muted and unmuted simultaneously. This allows you to create a separate mute group for each location.

**Deactivated:** The transmitter is not part of a mute group. Muting or unmuting does not affect other transmitters.

**i** The most recently saved status is retained even after you reset the device or the audio settings to the factory defaults.

### Mute All Microphones

Mutes all microphone input channels:

- Internal Mic.
- Ext. CH1
- Ext. CH2

### Audio Default Settings

Resets the audio settings (Low Cut and Sound Profiles) to the factory defaults.



**i** The last status saved in the “Location-based mute” field is retained even after you reset the audio settings to the factory defaults.

## Selecting a sound profile

Sound profiles are presets that are optimized for the intended mounting options.

You can either select a profile (recommended) or manually adjust the equalizer setting.

- ▶ In the Control Cockpit, navigate to **Devices > TC Bar > Audio**.
- ▶ Select the installed mounting type from the drop-down list (recommended). Optional: Select **Custom** to configure your own settings.

✓ The sound profile for your TC Bar has been selected.



## Setting the internal microphone noise gate

The noise gate ensures background noises are not intensified during pauses in speech.

In principle, the internal noise suppression function is able to effectively reduce noise from the room. However, there can be instances when an additional noise gate is required. The noise gate ensures background noises are not intensified during pauses in speech. This is especially important when several microphones are used simultaneously.

During speech pauses, for instance, the system automatically increases amplification owing to the assumption that insufficient signal strength is present. This causes the background noises to be amplified unnecessarily.

### Threshold

You can stipulate a **threshold value** as of which the system mutes the microphone. The noise gate does not open the audio output of the microphone until the microphone used exceeds the stipulated threshold value. With the slider, you can adjust the minimum threshold value from -70 dB to -30 dB in increments of 1 dB.

### Hold time

The **hold time** determines how quickly the microphone reduces the amplification. A delay of up to 500 ms can be set. You can set the hold time from 100 ms to 500 ms in increments of 50 ms.

#### To set the noise gate threshold value:

- ▶ In the Control Cockpit, navigate to **Devices > TC Bar > Audio**.
- ▶ Activate the function **Noise Gate** in the field **Internal Microphone Noise Gate**.
- ▶ Set the desired value under **Threshold**.
  - ✓ The threshold value has been set.

#### To set the hold time:

- ▶ In the Control Cockpit, navigate to **Devices > TC Bar > Audio**.
- ▶ Activate the function **Noise Gate** in the field **Internal Microphone Noise Gate**.
- ▶ Set the desired value under **Hold Time**.
  - ✓ The hold time has been set.

✓ The internal microphone noise gate has been set.



## Handling auto mix priority

You can use the auto mix priority to set the priority of the channels, including the internal microphone arrays, via individual controllers.

The TC Bar has up to two Dante® inputs for external microphone channels (ext. CH 1 and ext. CH 2). The channels make it possible to connect external devices (e.g., TeamConnect Ceiling Medium, etc.) to the TC Bar via a Dante® network. The Dante® inputs are managed using an integrated auto mixer, whereby the priority of the channels, including the internal microphone array, can be configured using individual faders.

**i** The settings for the auto mix priority manage only the priority of the selected channel. They have no effect on the actual amplification level of the connected microphones.

When the level is decreased using the corresponding controller, a virtual level reduction is added to the channel. This makes the auto mixer less likely to select the channel. Moving the controllers does not change anything about the levels displayed.

If you want to favor an individual channel from the selection, reduce the virtual amplification of the other two channels. The lower the dB number, the more likely the channel is to be selected.

Example:

Int. mic.	Ext. CH 1	Ext. CH 2	Explanation
-30 dB	-60 dB	0 dB	<ul style="list-style-type: none"><li>• Ext. CH 2 has the highest priority and is thus selected most often.</li><li>• Int. mic. has a lower priority and is thus selected less often.</li><li>• Ext. CH 1 has the lowest priority.</li></ul>
-60 dB	-10 dB	-30 dB	<ul style="list-style-type: none"><li>• Ext. CH 1 has the highest priority and is thus normally selected.</li><li>• Ext. CH 2 has a lower priority and is thus selected less often.</li><li>• Int. mic. has the lowest priority.</li></ul>
0 dB	-30 dB	-30 dB	<ul style="list-style-type: none"><li>• Int. mic. has the highest priority and is thus normally selected.</li><li>• Ext. CH 1 and 2 have a lower priority and are thus selected less often.</li></ul>



## Configuring fade time

You can use the fade time to configure the speed at which the devices switches between the audio sources connected to the auto mixer.

- ▶ Start by reducing the int. mic. by -30 dB.
- ▶ Speak in various positions and listen to whether the sound meets your expectations on the other end of a telephone conference.
- ▶ Select different values for the fade time and listen to the transition from one microphone to another.

✓ The fade time has been configured.



## Adapting far end output for TCC M

You can adapt the amplification of the TCC M signal with far end output.

The standard settings in TCC M are tailored to common application cases. In certain scenarios, you can use the following settings on the Audio tab in the Control Cockpit to finely adjust the output.

### To adapt the amplification in the Far End Output (digital) field of the TCC M:

- ▶ In the Control Cockpit, navigate to **Devices > TCC M > Audio**.
- ▶ Increase the amplification in the field **Far End Output (digital)** if the TCC M is very far from the audience.
- ▶ Decrease the amplification if the TCC M is very close to the audience.

### To configure the sensitivity of the beam freeze:

- ▶ In the Control Cockpit, navigate to **Devices > TCC M > Audio**.
- ▶ Increase the input level under **Manual gain** to activate the beam freeze earlier and thus achieve better echo suppression.
- ▶ Decrease the input level to improve the near end and double talk.
- ▶ Select **Automatic gain** if the seating in a room changes often, for example. Doing so allows the TCC M microphone to adjust itself to the best input level.

✓ The far end output was adjusted.



## Setting the volume

You can adjust the volume by using the control panel in Sennheiser's control software.

**i** You can also adjust the volume using the remote control and/or system settings of the operating system used or the conference system used (e.g., MS Teams, Zoom, etc.).

The volume can be adjusted within a range from 0 to 100.

Examples:



Volume 0

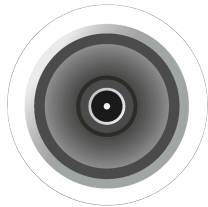

Volume 100

### WARNING



#### Danger due to high volume levels

Volume levels that are too high may damage your hearing.

- ▶ Reduce the volume and the microphone amplification, if applicable, before using the product.

To set the volume:

- ▶ In Control Cockpit, navigate to **Devices > TC Bar > Audio**.
- ▶ Adjust the volume under **Speaker Output** individually.

✓ The volume has been set.



## Muting internal TC Bar microphone

Use the remote control or your control software to mute or unmute the internal microphone.

- i** Muting the microphone can also be activated or deactivated using the system settings of the operating system and/or conference system in use (e.g., MS Teams, Zoom, etc.).

### Muting the TC Bar

- ▶ To mute the internal microphone of the TC Bar
  - Briefly push the mute button on the remote control or

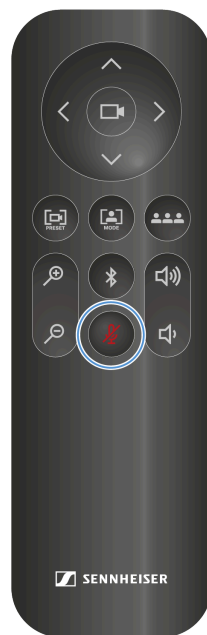

- Navigate to **Devices > TC Bar > Audio** in the Control Cockpit and activate the setting **Internal Mic Mute**.
- ✓ The lower LED for audio settings shines red. Muting is activated.

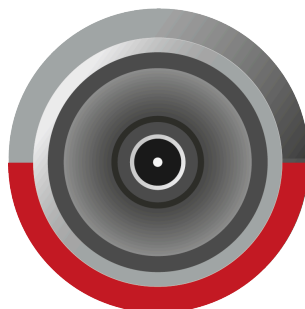



**Stop muting:**

- ▶ Stop the muting by doing the following:
  - Briefly push the mute button on the remote control or
  - Navigate to **Devices > TC Bar > Audio** in the Control Cockpit and deactivate the setting **Internal Mic Mute**.
- ✓ The red LED goes out. The audio output is no longer muted.

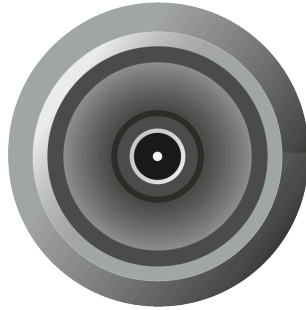

✓ The TC Bar has been muted.



## Muting all microphones

Mute all input channels with a single click.

**i** This function mutes all microphone input channels:

- Internal microphone
- External CH1
- External CH2

### To mute all input channels:

- ▶ In the Control Cockpit, navigate to **Devices > TC Bar > Audio**.
- ▶ Enable the slider labeled **All Microphones Mute**.
  - ✓ The lower LED for audio settings lights red, indicating muting is active.

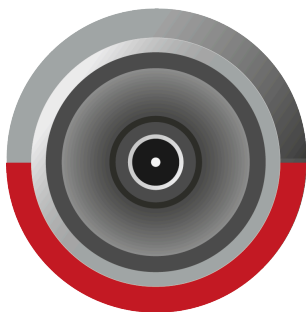

✓ All input mic channels have been muted.



## Enabling Dante® speaker output

Route audio to external Dante® speakers and disable the device's internal speakers.

When enabled, audio output is routed to external Dante® speakers and the device's internal speakers are muted.

- i** Before enabling this function, ensure that the Dante® protocols are enabled (see [Activating Dante® signal forwarding](#)). Also verify that routing has been configured in Audinate Apps before activation; otherwise, echo effects may occur.

### To enable the Dante® speaker output:

- ▶ In the Control Cockpit, navigate to **Devices > TC Bar > Audio**.
- ▶ Activate the slider in the field **External Dante® speaker output**.

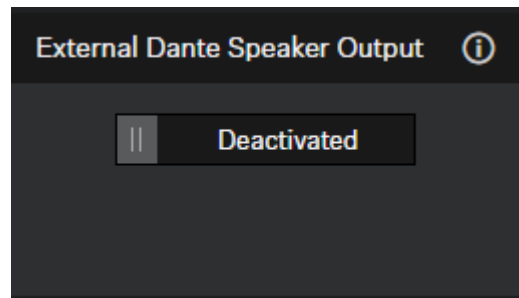

- ✓ Audio output is routed to the external Dante® speakers.



## Activating location-based mute

You can mute several devices in a room at the same time by using the mute switch on any transmitter.

In order to do so, you must add the device to the mute group for the location.

The following functions are available:

### Deactivated

The TC Bar is not part of a mute group. Muting or unmuting does not affect other transmitters.

### Part of group

Activate this function to add the TC Bar to a mute group. If one of the transmitters in this mute group is subsequently muted, all other transmitters in the same mute group at the same location will be muted or unmuted at the same time. This is how you can create your own mute group for each location.

**i** If you use the regular mute function via the TC Bar with a routed TCC M, we recommend setting the LED brightness of the **TCC M** to **0**. The mute function can be displayed only on the TC Bar, not on the TCC M.

## CAUTION



### Danger due to high volume levels

If the TCC M is routed, undesired echoes may occur if **Location-based Mute** is used during a conference. During muting, the microphone input current is paused, and, accordingly, the AEC cannot always assess the impulse response from the far end.

- ▶ Avoid using this function in combination with a routed TCC M.
- ▶ If you use the function, reduce the volume and, if applicable, the microphone amplification before reactivating this function.

### To activate the location-based mute function:

- ▶ In the Control Cockpit, navigate to **Devices > TC Bar > Audio**.
- ▶ Activate the function **Location-based Mute**.
  - ✓ The display switches to **Part of group**.

✓ Location-based mute has been activated.



## Resetting the audio settings

You can reset all audio settings to the factory settings.

### To reset all audio settings:

- ▶ In the Control Cockpit, navigate to **Devices > TC Bar > Audio**.
- ▶ Slide the controller for **Audio Default Settings** to the right and confirm it with **OK**.

✓ All audio settings were reset to the factory settings.



## Zones

The TeamConnect Bar allows you to define two different types of zones.

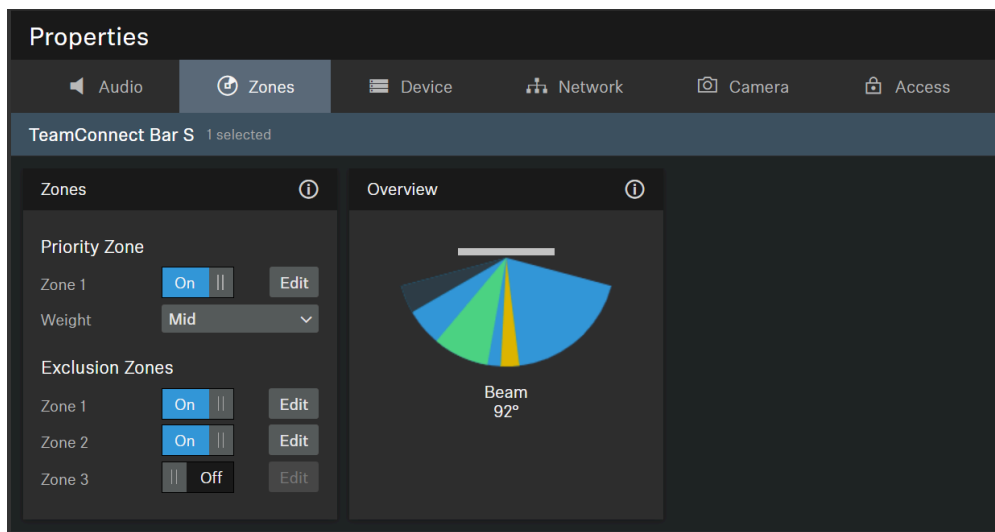

The TeamConnect Bar allows you to define two different types of zones:

- One Priority Zone - Zone to be preferred
- Up to three Exclusion Zones - Zones to be excluded

For each zone the horizontal angles can be set individually.

### Priority Zone

**i** In case both zone types overlap, the rules of the Exclusion Zone will apply.

The Priority Zone allows you to set up a zone which will be handled prioritized in case of incoming audio signals from different positions at the same time. This feature can be useful e.g. during conference meetings with an important person involved.

You can adjust a weighting for this zone. The weighting increases the focus on the incoming signals from the zone by the selected values. The following settings can be made:

- **Mid:** Increases the weighting on the audio output from the zone by about 1.5 times the normal value.
- **High:** Increases the weighting on the audio output from the zone by about 2.5 times the normal value.
- **Max:** Increases the weighting on the audio output from the zone by about 4 times the normal value.



**i** When defining the Priority Zone the area to be prioritized in the detection of the audio source is indicated green.

You can adjust the slider to set a Priority Zone. The zone can be adjusted individually from 15° to 165°. Minimum size for the angle: 15°.

### Exclusion Zones

**i** In case both zone types overlap, the rules of the Exclusion Zone will apply.

The TC Bar allows you to define up to three exclusion zones. By activating these zones all outgoing audio signals from these areas will be neglected.

**i** When defining the Exclusion Zones the area to be excluded in the detection of the audio source is indicated petrol.

You can adjust the sliders to set the exclusion zone. The horizontal zone can be adjusted individually from 15° to 165°.

### Overview

When you activate the zones, a 2D overview is created on the right, which displays all activated zones in real time. The zones in the 2D model are indicated either green (prioritized) or petrol (excluded).

### Overview

The zones overview displays all activated zones in an overall display.

If you activate the zones, a 2D overview is created on the right-hand side and displays all the activated zones in real time. The zones in the 2D model are marked either green (prioritized) or petrol blue (excluded).

**i** If both zone types overlap, the rules of the exclusion zone apply.



## Creating a priority zone

You can use a priority zone to prioritize an important audio area in a room (such as the position of a speaker).

During lively discussions in meetings, the moderator must be able to retain control of the conversation. You can create a priority zone so that voices have priority for reasons besides volume alone. The moderator is always preferred in the incoming signal, even if their voice is quieter. That ensures that the person responsible always has control of the situation regarding voices as well.

You can also configure weighting for the priority zone. The weighting determines how intensively the beam concentrates on this area. You have the following options:

### Mid

- Increases the weighting of the audio signals in the priority zone to approximately 1.5 times the normal audio output (e.g., in rooms with normal ambient noise). Thus, the source outside the priority zone must be 2 dB louder than a source within the priority zone to cause the beam to focus on the source outside the zone.

### High

- Increases the weighting of the audio signals in the priority zone to approximately 2.5 times the normal audio output (e.g., in rooms with high ambient noise). Thus, the source outside the priority zone must be 4 dB louder than a source within the priority zone to cause the beam to focus on the source outside the zone.

### Max

- Increases the weighting of the audio signals in the priority zone to approximately 4 times the normal audio output (e.g., in rooms with strong ambient noise and a quiet moderator). Thus, the source outside the priority zone must be 6 dB louder than a source within the priority zone to cause the beam to focus on the source outside the zone.

**i** If the priority zone overlaps the exclusion zones, the settings for the exclusion zones apply.

### To configure a priority zone:

- ▶ In the Control Cockpit, navigate to **Devices > TC Bar > Zones**.
- ▶ Under **Zones > Priority Zone**, click the button **Off** to activate the zone.
  - ✓ The switch then changes to the mode **On**.
- ▶ Click **Edit**.



- ▶ Configure the desired priority zone manually in the specified radius.
- ▶ Click **Apply** to save the settings.
  - ✓ The priority zone has been set.

**To set the weighting of the priority zone:**

- ▶ Under **Zones > Priority Zone > Weight**, select the desired setting from among the values **Mid**, **High** or **Max**.
  - ✓ The weighting has been set.

✓ The priority zone has been configured.



## Configuring exclusion zones

You can use exclusion zones to exclude unwanted areas from audio recording.

Air conditioners, side doors, loud coffee machines, and adjoining rooms can produce undesired noises. Speakers with audio signals from distant participants can also be a source of disruption for the microphone.

To exclude these undesired background noises, you can define exclusion zones in which the beam tracking function ignores audio signals.

You can configure up to three exclusion zones and activate them at the same time. As soon as the device is initialized, the TC Bar uses a real-time algorithm to detect sources of noise that are then visualized directly in the Control Cockpit as a 2D model. That allows you to quickly and easily localize the source of disruption and define a precise exclusion zone for this area.

### To configure one or more exclusion zones:

- ▶ In the Control Cockpit, navigate to **Devices > TC Bar > Zones**.
- ▶ Under **Zones > Exclusion Zones**, click the button **Off** for the desired zone from 1 to 3 to activate the exclusion zone.
  - ✓ The switch then changes to the mode **On**.
- ▶ Click **Edit**.
- ▶ Configure the desired exclusion zone manually in the specified radius.
- ▶ Click **Apply** to save the settings.

✓ The exclusion zones have been configured.



## Device Settings

The following device settings are available for the TC Bar.

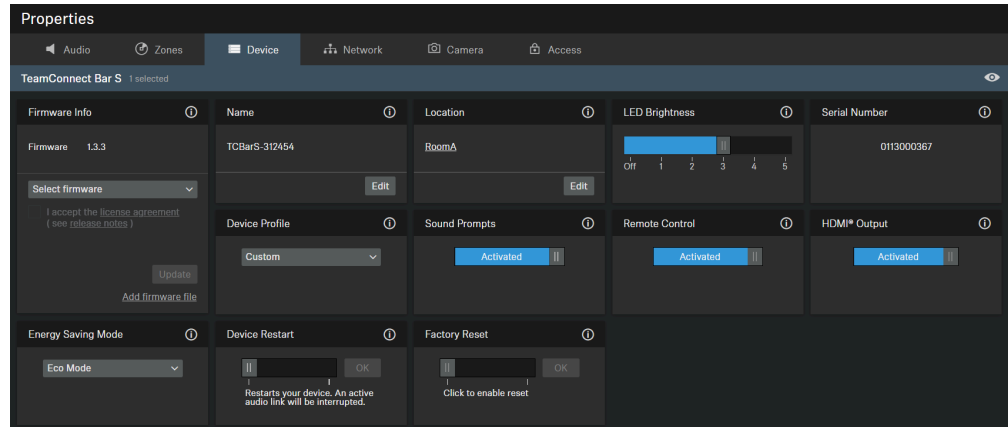

1. [Remote Control](#)
2. [Energy Saving Mode](#)

### Firmware Info

Displays the current firmware version.

For information on how to update the firmware, refer to [Updating device firmware](#).

### Name

Edits the name of a device. The name will be stored on the device. If you change the name on the device itself, it will be displayed here accordingly.

### Location

Sets the location of the selected device.

The field is limited to 255 bytes length including any UTF-8 characters.

### LED Brightness

Slider for adjusting the LED brightness.

- **Off:** the LEDs are switched off completely
- **1 ... 5:** adjusts the brightness between low (1) and high (5)

### Serial Number

Displays the serial number.



## Device Profile

Here you can select the desired device profile, which is applied either from your own configured settings or from the predefined settings of the selected conference and collaboration platform.

**i** When changing the device profile, the camera settings will be reset and the device will be restarted.

- **Custom:** own device profile
  - Enables all settings in the **Camera** tab as well as the HDMI output in the **Device** tab
- **Microsoft Teams:** predefined by Microsoft Teams

**i** Using this profile, the camera zoom of the TC Bar is reduced to comply with Microsoft Teams specification.

- Enables the default settings for Microsoft Teams
- Resets all settings in the **Camera** tab
- Disables the HDMI output in the **Device** tab
- Reboots the device
- **Zoom:** predefined by Zoom

**i** Using this profile, the camera zoom of the TC Bar might be changed to comply with Zoom specification.

- Enables the default settings for Zoom
- Resets all settings in the **Camera** tab
- Reboots the device

## Sound Prompts

Activates or deactivates all integrated sounds of the TC Bar with the exception of the welcome prompt.

## Remote Control

Activates or deactivates the use of the infrared remote control of the TC Bar.

## Device Restart

Restarts the selected device.



## HDMI output

Activates the HDMI output signal to external display.

- i** If you select "Microsoft Teams" as the "Device Profile", the HDMI output is deactivated.

## Energy Saving Mode

Depending on required availability and response time, configure the energy-saving mode to meet the TC Bar's use-case needs.

- i** For detailed information about the prerequisites for entering a specific standby mode and about the maximum power consumption, please refer to the chapter [Status information about energy consumption](#) in the TC Bar manual.

- **Low Power Mode** (optional)
  - Optional mode
  - Puts the device into deep sleep mode to reduce power consumption
  - Waking the device requires a manual power-on operation
  - Remote wake-up is not possible because there is no longer a network connection
- **Eco Mode** (Default)
  - Default mode in the factory-delivered state (firmware  $\geq 1.3.0$ )
  - Puts the device into a state of minimal power consumption to ensure availability and a quick response time over Ethernet.
  - Remote wake-up is possible
- **Always On Mode** (optional)
  - Optional mode
  - Explicitly recommended for devices that must be available 24/7 for administration purposes
  - Must be explicitly confirmed by the user
  - Device will no longer be automatically placed into any ECO mode
  - The power consumption is not reduced
  - The device remains constantly in an operational state and can be accessed at any time.

## Factory Reset

All settings of the selected device are reset to the factory defaults.

- i** The last saved status of the **Location-based mute** function is retained even after you reset the device to the factory default.



## Updating the firmware

When the PC running the Sennheiser Control Cockpit software is connected to the Internet, the most recent firmware versions for all update-able devices is automatically made available.

**i** In order to use the latest features of the software and in order for all devices to work properly, we strongly recommend keeping the firmware of all devices up to date.

**i** For security reasons, firmware (FW) updates are not backward compatible; therefore, FW versions older than the currently installed version cannot be uploaded.

### ATTENTION



#### Loss of data if the firmware transfer is interrupted

If the transfer is interrupted, this may lead to a loss of data. The devices may be damaged by this.

- ▶ Do not remove any connections to the stationary devices during firmware updates.

- ▶ In the Control Cockpit, navigate to **Devices > TC Bar > Device**.
  - ✓ The Firmware Info dialog indicates the available firmware versions.
- ▶ From the drop-down list, select the firmware version you want to install.

**i** To add manually downloaded firmware, click on Add firmware file and select the downloaded file. Firmware versions downloaded automatically by the Control Cockpit are marked **via update server**. Firmware versions downloaded manually by yourself are marked **added manually**.

- ▶ Click on **Update**.
  - ✓ The firmware of the TC Bar is updated. Afterwards, the device reboots. The LED display presents a short demo.

✓ The firmware has been successfully updated.



## Setting LED brightness

This setting adjusts the brightness of the LEDs on the TC Bar.

The brightness can be set from 0 (off) to 5 (very bright).

### To set the LED brightness:

- ▶ In the Control Cockpit, navigate to **Devices > TC Bar > Device**.
- ▶ Set the value you want from 0 (off) to 5 (very bright) in the **LED Brightness** field.

✓ The LED brightness has been set.



## Stipulating a device profile for the camera

Device profiles contain custom or predefined settings for supported conference and collaboration platforms.

- **Custom:** Activates all the settings on the **Camera** tab and the HDMI output on the **Device** tab.
- **Microsoft Teams:**
  - Activates the standard settings for Microsoft Teams.
  - Resets all settings on the **Camera** tab.
  - Deactivates the HDMI output on the **Device** tab.
  - Restarts the device.

**i** This profile reduces the camera zoom of the TC Bar in order to fulfill the specifications of Microsoft Teams.

- **Zoom**
  - Activates the standard settings for Zoom.
  - Resets all settings on the **Camera** tab.
  - Restarts the device.

**i** This profile reduces the camera zoom of the TC Bar in order to fulfill the specifications of Zoom.

### To select the device profile for the camera:

**i** When the device profile is changed, the camera settings are reset, and the device is rebooted.

- ▶ In the Control Cockpit, navigate to **Devices > TC Bar > Camera**.
- ▶ Select the desired profile under **Device Profiles**.

✓ The device profile for the camera has been defined.



## De-/activating sound prompts

This function activates or deactivates the integrated sounds when the device is turned on and off and when the TC Bar is connected to or disconnected from other devices.

### To de-/activate sound prompts:

- ▶ In the Control Cockpit, navigate to **Devices > TC Bar > Device**.
- ▶ Activate or deactivate the function under **Sound Prompts**.

✓ Sound prompts were de-/activated.



## Rebooting the TC Bar

You can configure the TC Bar using the control panel in Sennheiser's control software.

**i** When the TC Bar is rebooted, all active connections are interrupted.

### To reboot the TC Bar:

- ▶ In the Control Cockpit, navigate to **Devices > TC Bar > Device**.
- ▶ Slide the control under **Device Restart** to the right and click **OK**.

✓ The device is rebooted.

**i** The TC Bar is also rebooted as soon as a device profile for the camera is activated in the Control Cockpit.



## Activating the HDMI® output

You can activate the HDMI® output in order to transmit video signals to external screens.

**i** Please note that the HDMI® output is always deactivated when the device profile **Microsoft Teams** is used.

### To activate the HDMI® output:

- ▶ Make sure the most recent version of the driver for DisplayLink® is installed on your connected device. You can find the most recent version on the website [DisplayLink®](#).
- ▶ In the Control Cockpit, navigate to **Devices > TC Bar > Device**.
- ▶ Under **HDMI® Output**, click the switch **Deactivated**.
  - ✓ The switch changes to the status **Activated**.

✓ The HDMI® output has been activated.



## Changing energy-saving mode

Adjust the device's power-saving mode according to your requirements.

You can adjust the energy-saving mode according to your infrastructure and the required use cases. Select the appropriate mode for this:

- **Eco Mode** (default)
- **Low Power Mode** (optional)
- **Always On Mode** (optional)

### CAUTION



#### Increased power consumption in Always On Mode

Enabling **Always On Mode** will increase the device's power consumption. This mode bypasses energy-saving functions and keeps the device fully active at all times.

- ▶ Enable this mode only if the device must be available 24/7 for remote access.

To change the energy saving mode:

- ▶ In the Control Cockpit, navigate to **Devices > TC Bar > Device**.
- ▶ Select the mode under **Energy Saving Mode**.

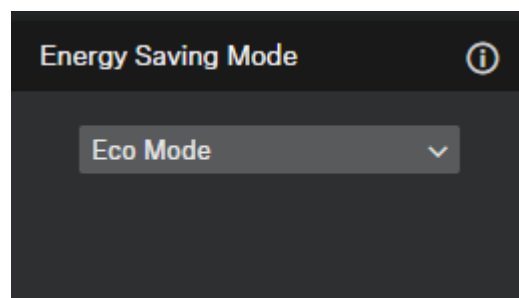

- ▶ If **Always On Mode** was selected, confirm the message that you have been informed about the device's increased power consumption.

✓ The energy saving mode has been changed.



## Resetting the TC Bar to factory settings

You can reset the device to the factory settings manually by pressing the button on the back of the device or remotely using the control panel in the Sennheiser Control Cockpit app.

### ATTENTION



#### Loss of data after resetting to factory settings

All active connections are interrupted, and all settings are reset to the factory settings.

All the personal data that the internal memory had recorded is irrevocably deleted.

- ▶ Make sure that no connections are being actively used at the time of the reset.
- ▶ Check whether all relevant personal data has been properly deleted.

▶ Reset the TC Bar to the factory settings by either:

- Holding down the reset button on the back of the device at least 7 seconds,

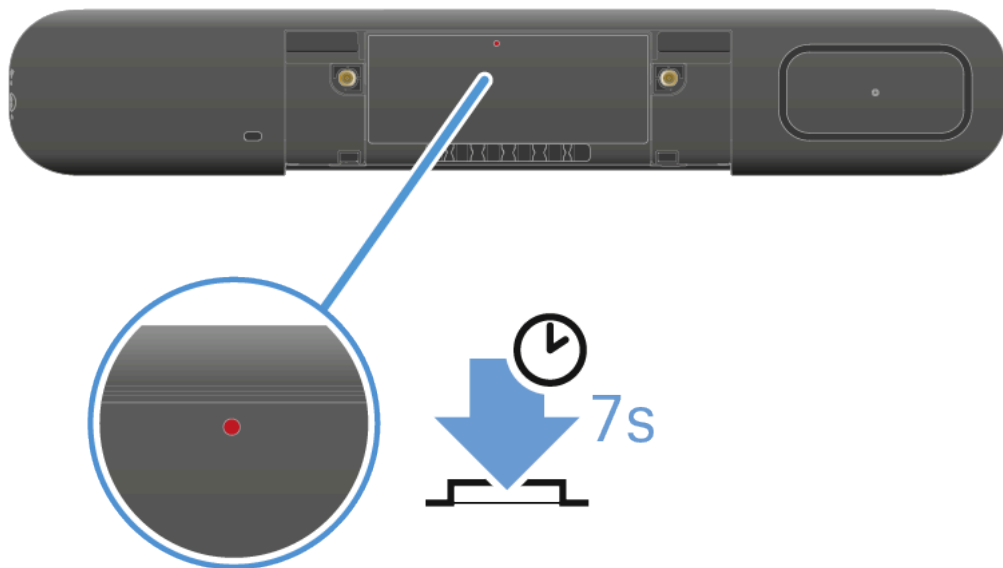

or

- In the Control Cockpit, navigate to **Devices > TC Bar > Device**, and under **Factory Reset** slide the slider to the right. Confirm the setting with **OK**.
- ✓ There is a brief sound, and the red LED slowly flashes. The TC bar is reset and then rebooted. The white LED flashes during the boot process. A short melody sounds when the device is ready for operation.



✓ The TC Bar has been reset and is ready for operation.



## Network Settings

The following network settings are available for the TC Bar.

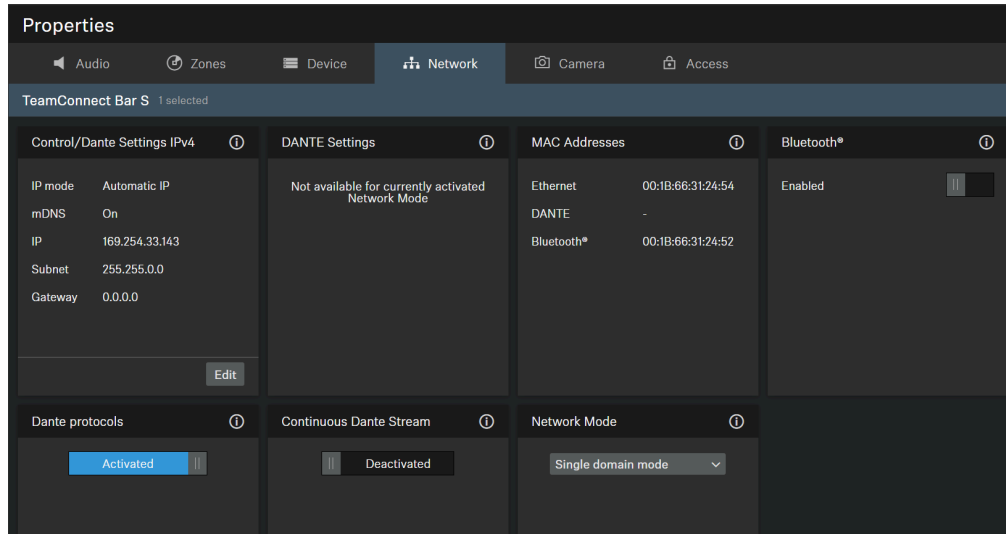

### 1. Continuous Dante® Stream

## Control/Dante Settings IPv4

### IP Mode

- **Automatic:** The IP address is automatically assigned using DHCP. If no DHCP server is available, the IP address is assigned by the SL Rack Receiver DW itself.
- **Fixed IP:** The IP address has to be entered manually.

### mDNS

- **Off:** Deactivates mDNS to reduce the data volume transferred across the network. This option is recommended for larger systems.
- **On:** Activates mDNS to allow for automatic device detection. This option is recommended for smaller systems with up to 30 devices.

### IP

- Input of the IP address in Fixed IP mode.

### Subnet

- Input of the subnet mask in Fixed IP mode.

### Gateway

- Input of the gateway in Fixed IP mode.



## Dante Settings

- **Automatic:** The IP address is automatically assigned using DHCP or Zero Configuration. If no DHCP server is available, the IP address is assigned by the TeamConnect Bar itself.
- **Fixed IP:** The IP address has to be entered manually.
- **IP:** Input of the IP address in Fixed IP mode.
- **Subnet:** Input of the subnet mask in Fixed IP mode.
- **Gateway:** Input of the gateway in Fixed IP mode.
- **VLAN ID:** VLAN ID field to be routed to the correct network (default = 100).

A VLAN separates a physical network into logical sub-networks. This enables several virtual networks to be created from one physical switch port. When using Dual Domain Mode, Dante® and Control Cockpit can be used separately. In case of Dante® network, this can be virtually separated and operated independently using a VLAN with just one network connection. The frames are given a tag containing a VLAN ID. This provides the switch port with information on which Dante® VLAN the frame belongs to.

## MAC Address

Displays the unique MAC addresses of the device according to the connected ports.

## Bluetooth®

Bluetooth is deactivated by default. In order to activate BT and connect the TC Bar to a BT-compatible device:

- Click on **Enabled** to activate the BT function and wait approx. 10 sec in order to let the device process the initial activation.
- Click on **Start** to start the pairing process.
- In your device, search for your TC Bar name and click on **Connect**. If the TC Bar is not yet visible, repeat the pairing process again.

**i** Devices that have already been paired are displayed under **Known Devices**.

## DANTE Protocols

Enables a digital audio network protocol over Ethernet for routing and synchronization of Dante-compatible devices using the Dante Controller software.



## Continuous Dante® Stream

- Enables continuous transmission of microphone streams over Dante®.

**i** Audio data will be streamed permanently over Dante®. This may increase power consumption. Ensure that continuous audio streaming over Dante® complies with your regional security and regulatory requirements before enabling.

### CAUTION



#### Risk from unencrypted audio communication

Communication over Dante® is not encrypted by default and can be eavesdropped on and misused by 3<sup>rd</sup> parties.

- ▶ Enable continuous transmission over Dante® only when no sensitive content is being transmitted.
- ▶ Encrypt your communication for sensitive content using [Dante Media Encryption feature](#) in [Dante Director](#).

## Network Mode

Displays the Dante® Network port configuration of the selected device.

- Single Domain Mode (default mode for TC Bar and TC Bar M):
- Dual Domain Mode (for TC Bar S and TC Bar M)
- Split mode (only for TC Bar M)

### Single Domain Mode:

- This mode is usually used if you want to use both the controller (Sennheiser or third-party provider) and Dante® on the same physical port with only one available IP in the same network. To set up both configurations, you need the Sennheiser Control Cockpit for the control network and the Dante Controller for other routed Sennheiser devices.

### Dual Domain Mode:

- This mode is generally used if you receive a merged flow from two separate networks via a single network line and you want to resolve this merged flow back into two different IP and MAC addresses. In this way you can operate the Dante® network and the control network independently of each other via the same switch.
- Outgoing Dante® data packets are tagged as a VLAN (Virtual Local Area Network) in accordance with the 802.1q standard. The incoming data packets must also be tagged by the externally connected network in order to be able to assign them correctly for internal use. Depending on the device, the data packets may need to be translated from the outgoing 802.1q standard to 802.3 via a managed switch.



#### Split Mode:

- This mode is generally used if you receive a mixed signal from two separate networks via a single network line and want to resolve this mixed signal back into two different IP addresses. In this way, you want to operate the Dante network and the control network independently of each other and use a separate switch for each network.

### Activating tagged VLAN (Dante® network)

A VLAN (virtual local area network) separates a physical network into partial networks. As a result, you can set up several virtual networks from a physically existent switch port (such as the Dante® network and control software network).

The TC Bar supports the prioritizing technology **tagged VLAN** as per IEEE 802.1Q. Thus, for example, when the TC Bar S is used with only a network connection, the Dante® network and the control software network can be separated virtually and operated independently. In the process, the frames for the Dante® network receive a tag (marking) that contains the VLAN ID. That is how the switch port receives information about the Dante® VLAN to which the frame belongs.

- i** When the TC Bar M is used, the Dante® network and control software network can be operated independently of one another via the two existing network ports. To do this, select the network mode **Split Mode**. You can find more information in the chapter [Split mode](#).

#### To activate tagged VLAN for a Dante® network:

- ▶ In the Control Cockpit, navigate to **Devices > TC Bar > Network**.
- ▶ In the **Network Mode** window, select the mode **Dual Domain Mode**.
  - ✓ The device will be rebooted.
- ▶ In the **Dante® Settings** window, click **Edit**.
- ▶ In the field **VLAN ID**, enter the correct ID in order to be routed to the correct network.
- ▶ Click **OK** to save the changes.

- ✓ Tagged VLAN has been activated.



## Activating Bluetooth®

When the device is delivered, Bluetooth® is deactivated and can be activated in the Control Cockpit.

- i** Please note that after the Bluetooth® function is activated, the Bluetooth® pairing process must be started in order to create a connection (see [Starting Bluetooth® pairing](#)).

### To activate Bluetooth®:

- ▶ In the Control Cockpit, navigate to **Devices > TC Bar > Network**.
- ▶ Under **Bluetooth**, activate the Bluetooth® switch and wait approximately 10 seconds for the operating system to activate the function.

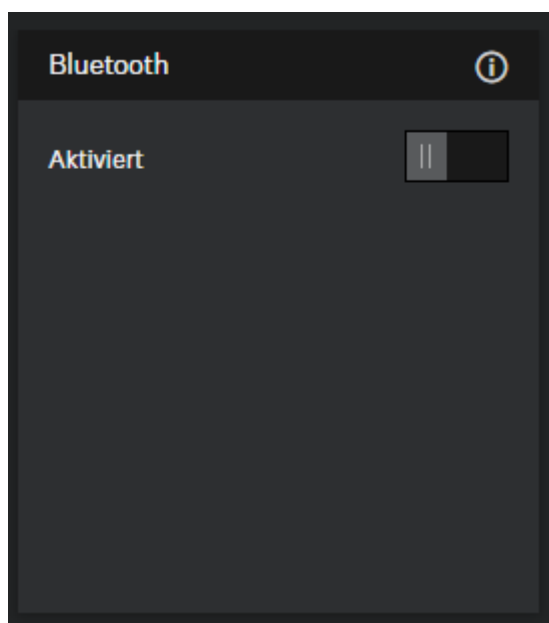



- ✓ The Bluetooth® function has been activated.

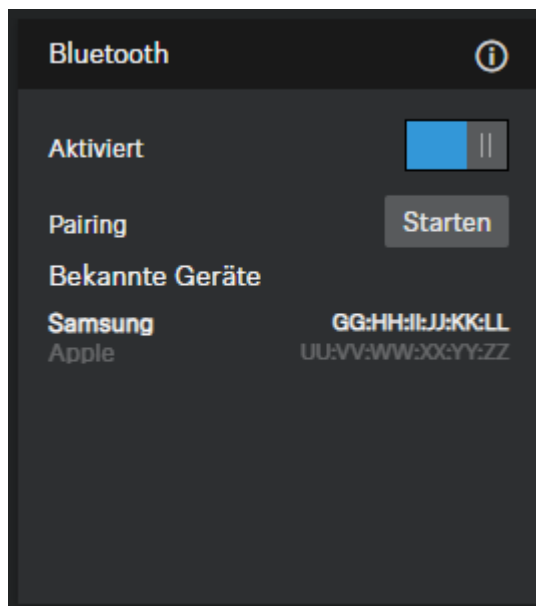

- ✓ You can now begin the Bluetooth® pairing process (see [Starting Bluetooth® pairing](#)).



## Starting Bluetooth® pairing

The pairing process can be started using the Bluetooth® button.

- i** Please note that Bluetooth® is deactivated in the factory settings. To create a Bluetooth® connection with a device that is capable of Bluetooth®, you must activate the Bluetooth® function in the Control Cockpit and then start the pairing process ([Activating Bluetooth®](#)).

There are several ways to start the Bluetooth® pairing process:

- Using the Sennheiser Control Cockpit software
- Using the initialization button on the TC Bar
- Using the remote control

To start Bluetooth® pairing using the Sennheiser Control Cockpit software:

- ▶ In the Control Cockpit, navigate to **Devices > TC Bar > Network**.
- ▶ Under **Bluetooth®**, click the switch **Start**.

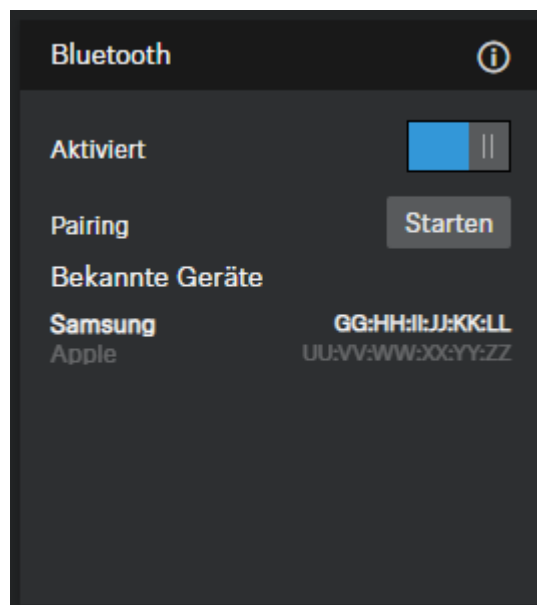



- ✓ The blue LED flashes. Bluetooth pairing is activated. The device is in pairing mode and can be connected to a device that is capable of Bluetooth.



**To start Bluetooth® pairing via the TC Bar:**

- ▶ Press the Bluetooth® pairing button on the left side of the TC Bar for at least three seconds.
- ✓ The blue LED flashes. Bluetooth pairing is activated. The device is in pairing mode and can be connected to a device that is capable of Bluetooth.

**To start Bluetooth® pairing via the remote control:**

- ▶ Press the Bluetooth® pairing button on the remote control for at least three seconds.



- ✓ The blue LED flashes. Bluetooth pairing is activated. The device is in pairing mode and can be connected to a device that is capable of Bluetooth.

✓ Bluetooth® pairing has begun. You can now couple the TC Bar with a device that is capable of Bluetooth® (see [Coupling the TC Bar a device capable of Bluetooth®](#)).



## Activating Dante® signal forwarding

Using the Dante controller software, you can activate a digital audio network protocol via Ethernet for the routing and a synchronization of Dante®-compatible devices.

**i** Please note that the audio signal via Dante® is not encrypted!

To route additional Sennheiser Audio devices to the TC Bar, the following steps must be performed:

- Activating the Dante® protocol in the Sennheiser Control Cockpit
- Forwarding the audio signals in the Dante controller

### To activate the Dante® protocol:

- ▶ In the Control Cockpit, navigate to **TC Bar > Network**.
- ▶ Activate the slider in the field **Dante® protocols**.

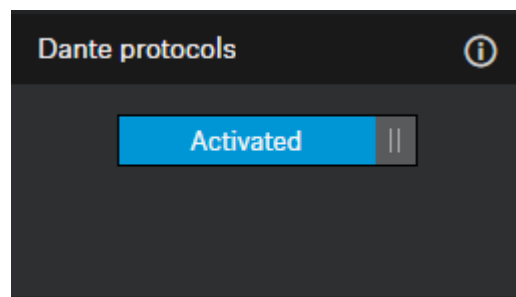

- ✓ The Dante® protocol was activated.

### To route TCC M signals to the TC Bar, for example

- ▶ Guide the **FarEndOut** from the TCC M to **ExternalMicIn1** of the TC Bar (or **ExternalMicIn2**).
- ▶ Guide the **FarEndRefOut** of the TC Bar to the **FarEndRef** of the TCC M.

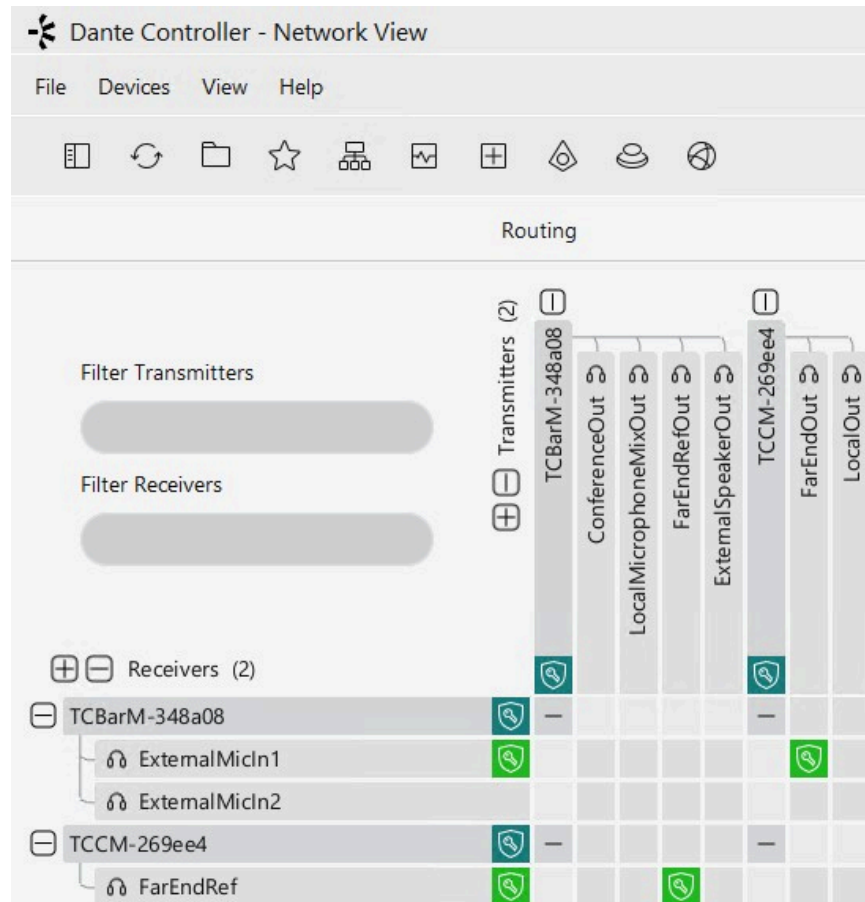

**i** We strongly recommend using the beam freeze function of the TCC M microphone. Our tests have shown that the TC Bar's echo suppression is far better when the beam freeze function is used.

✓ Forwarding AV signals via the Dante controller has been activated.



## Activating the continuous Dante® stream

This function enables the continuous transmission of microphone streams over Dante®.

- i** Audio data will be streamed permanently over Dante®. This may increase power consumption. Ensure that continuous audio streaming over Dante® complies with your regional security and regulatory requirements before enabling.

### CAUTION



#### Risk from unencrypted audio communication

Communication over Dante® is not encrypted by default and can be eavesdropped on and misused by 3<sup>rd</sup> parties.

- ▶ Enable continuous transmission over Dante® only when no sensitive content is being transmitted.
- ▶ Encrypt your communication for sensitive content using [Dante Media Encryption feature](#) in [Dante Director](#).

To enable the continuous Dante® stream:

- ▶ In the Control Cockpit, navigate to **Devices > TC Bar > Network**.
- ▶ Activate the toggle in the field **Continuous Dante® Stream**.

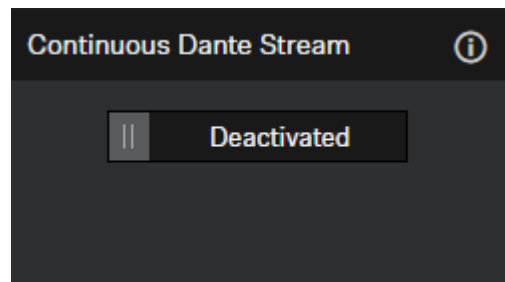

- ✓ The continuous Dante® stream has been activated.



## Selecting a network mode

You can configure the various network modes using the panel in Sennheiser's control software.

**The TC Bars are in the following network modes in the factory settings:**

- TC Bar S: Single domain mode
- TC Bar M: Split mode

**To select a network mode:**

- ▶ In the Control Cockpit, navigate to **Devices > TC Bar > Network**.
- ▶ Select a network mode from among the following options:
  - Single domain mode
  - Dual domain mode
  - Split mode (only for TC Bar M)

✓ The network mode has been selected.



## Camera Settings

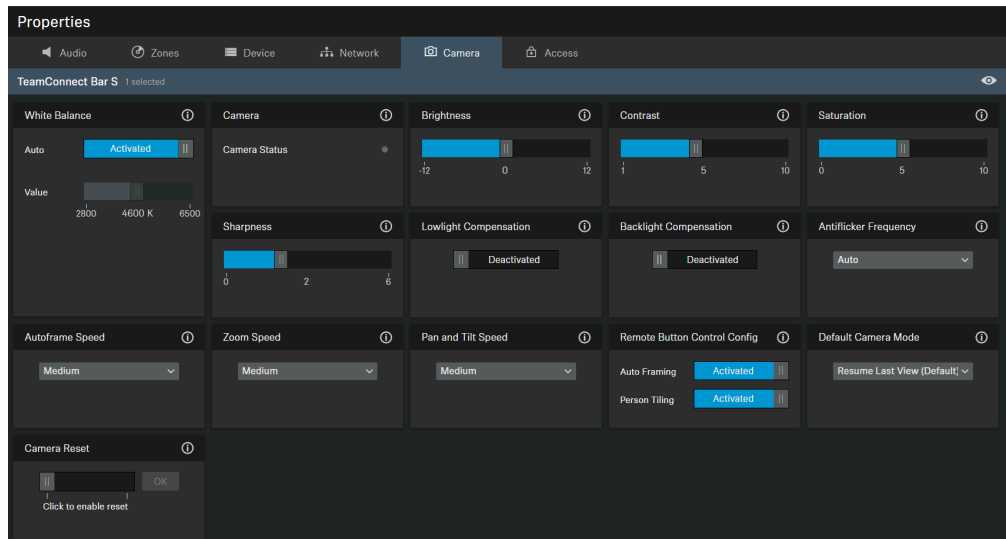

### 1. Default Camera Mode

#### White Balance

Adjusts the video image for natural color representation. The white balance can be set either automatically or manually.

#### Camera Status

Shows current status (enabled or disabled) of the camera.

#### Brightness

Adjusts the brightness of the video image from **-12** (dark) to **12** (very bright).

#### Contrast

Adjusts the contrast between light and dark parts of the video image from **1** (low contrast) to **10** (high contrast).

#### Saturation

Adjusts the color saturation of the video image from **0** (low saturation) to **10** (high saturation).

#### Sharpness

Adjusts the level of detail in the video image.



### **Lowlight Compensation**

Increases the camera sensitivity in scenes with low lighting. Either Backlight Compensation or Lowlight Compensation can be used.

### **Backlight Compensation**

Increases the exposure of the camera in backlight conditions. Either Backlight Compensation or Lowlight Compensation can be used.

### **Antiflicker Frequency**

Reduces image flickering caused by AC driven lighting sources.

### **Autoframe Speed**

Controls the speed of automatic zooming.

### **Zoom Speed**

Controls the speed of manual zooming.

### **Pan and Tilt Speed**

Controls the pan and tilt speed of the camera.

### **Remote Button Control Config**

Activates or deactivates functions Auto Framing and/or Person Tiling on the remote control.

### **Default Camera Mode**

Applies the TC Bar's default view at the start of each call.

**i** Any temporary changes made with the IR remote apply only to the current call.

The following modes are available:

- **Resume Last View** (Default): In this mode, the last saved changes will be applied.
- **Full Field of View**: Displays the entire field of view.
- **Auto Framing**: Focuses on participants in the room and maintains this focus at all times.



- **Person Tiling:** Automatically divides recorded participants into individually tailored frames.
- **User Preset:** All user configured camera settings will be applied.

### Camera Reset

Resets the preset camera settings to default settings.

## Creating a user-defined device profile

You can create a user-defined profile using the Sennheiser Control Cockpit software.

You can adjust the individual camera settings in the device profile **Custom**. You can configure the following settings for the camera:

- **Zoom speed:**
  - Regulates the speed of the automatic zoom in a video image.
- **Auto frame speed:**
  - Regulates the switching speed of the windows between the participating areas.
- **Backlight compensation:**
  - Increases the camera's exposure in the event of backlighting. Either the backlight compensation or the lowlight compensation function can be used.
- **Exposure:**
  - Adapts the camera to scenes with different lighting conditions. The exposure can be set automatically or manually.
- **Lowlight compensation:**
  - Increases the camera's sensitivity for scenes with low lighting. Either the backlight compensation or the lowlight compensation function can be used.
- **Sharpness:**
  - Adjusts the level of detail in the video image.
- **White balance:**
  - Adapts the video image so the colors are portrayed naturally. The white balance can be set either automatically or manually.
- **Saturation:**
  - Adapts the color saturation of the video image from 0 (low saturation) to 10 (high saturation).
- **Contrast:**
  - Adapts the contrast between the light and dark parts of the video image from 1 (low contrast) to 10 (high contrast).
- **Brightness:**
  - Adjusts the brightness of the video image from -12 (dark) to 12 (very bright).

**i** When the device profile is changed, the camera settings are reset, and the device is rebooted.



**To configure the camera:**

- ▶ In the Control Cockpit, navigate to **Devices > TC Bar > Camera**.
- ▶ Adjust the settings for the camera in the corresponding windows.

✓ The user-defined device profile has been created.

## Setting the white balance

The white balance adapts the video image so the colors are portrayed naturally.

The white balance can be set either automatically or manually between 2800 K and 6500 K.

**To set the white balance automatically:**

- ▶ In the Control Cockpit, navigate to **Devices > TC Bar > Camera**.
- ▶ In the field **White Balance**, activate the button **Auto**.
- ✓ The white balance is set automatically.

**To set the white balance manually:**

- ▶ In the Control Cockpit, navigate to **Devices > TC Bar > Camera**.
- ▶ In the field **White Balance**, deactivate the button **Auto**.
- ▶ Set the value you want between 2800 K and 6500 K.

✓ The white balance has been set.



## Setting brightness

This setting adjusts the brightness of the video image.

The brightness can be adjusted manually within a range of -12 to 12.

### To adjust the brightness:

- ▶ In the Control Cockpit, navigate to **Devices > TC Bar > Camera**.
- ▶ Set the value you want from -12 (dark) to 12 (very bright) in the **Brightness** field.

✓ The brightness has been set.



## Setting contrast

This setting adjusts the contrast between the light and dark parts of the video image.

The contrast can be set manually from 1 (low contrast) to 10 (high contrast).

### To set the contrast:

- ▶ In the Control Cockpit, navigate to **Devices > TC Bar > Camera**.
- ▶ In the **Contrast** field, set the value you want from 1 (low contrast) to 10 (high contrast).

✓ The contrast has been set.



## Setting saturation

This setting adjusts the saturation of the video image.

The saturation can be set from 0 (no change) to 10 (high saturation).

### To set the saturation:

- ▶ In the Control Cockpit, navigate to **Devices > TC Bar > Camera**.
- ▶ In the **Saturation** field, set the value you want from 0 (no change) to 10 (high saturation).

✓ The saturation has been set.



## Setting sharpness

This setting adjusts the sharpness of the video image.

The sharpness can be set from 0 (no change) to 6 (very sharp).

### To set the saturation:

- ▶ In the Control Cockpit, navigate to **Devices > TC Bar > Camera**.
- ▶ In the **Sharpness** field, set the value you want from 0 (no change) to 6 (very sharp).

✓ The sharpness has been set.



## Activating lowlight compensation

Lowlight compensation increases the camera's sensitivity for scenes with insufficient lighting.

Either the backlight compensation or the lowlight compensation function can be used.

### To activate the lowlight compensation function:

- ▶ In the Control Cockpit, navigate to **Devices > TC Bar > Camera**.
- ▶ Activate the function in the field **Lowlight Compensation**.

✓ Lowlight compensation has been activated.



## Activating backlight compensation

Backlight compensation increases the camera's exposure in the event of backlight.

Either the backlight compensation or the lowlight compensation function can be used.

### To activate backlight compensation:

- ▶ In the Control Cockpit, navigate to **Devices > TC Bar > Camera**.
- ▶ Activate the function in the field `Backlight Compensation`.

✓ Backlight compensation has been activated.



## Setting the anti-flicker frequency

The anti-flicker frequency reduces flickering in the image that is caused by sources of light powered by alternating current.

The following settings can be selected:

- Off
- Automatic
- 50 Hz
- 60 Hz

### To set the anti-flicker frequency:

- ▶ In the Control Cockpit, navigate to **Devices > TC Bar > Camera**.
- ▶ Select the desired setting in the drop-down menu.

✓ The anti-flicker frequency has been set.



## Setting the auto frame speed

The auto frame speed controls the speed of the automatic zoom.

The following settings can be selected:

- Slow
- Medium
- Fast

### To set the auto frame speed:

- ▶ In the Control Cockpit, navigate to **Devices > TC Bar > Camera**.
- ▶ Select the desired setting in the drop-down menu.

✓ The auto frame speed has been set.



## Setting the zoom speed

The zoom speed controls the speed of the manual zoom.

The following settings can be selected:

- Slow
- Medium
- Fast

### To set the zoom speed:

- ▶ In the Control Cockpit, navigate to **Devices > TC Bar > Camera**.
- ▶ Select the desired setting in the drop-down menu.

✓ The zoom speed has been set.



## Setting the panning and tilting speed

The panning and tilting speed controls the speed at which the camera pans and tilts.

The following settings can be selected:

- Slow
- Medium
- Fast

### To set the panning and tilting speed:

- ▶ In the Control Cockpit, navigate to **Devices > TC Bar > Camera**.
- ▶ Select the desired setting in the drop-down menu.

✓ The panning and tilting speed has been set.



## Activating the functions for remote control

Activate the auto framing and person tiling functions so you can use them conveniently via remote control.

You can activate and deactivate the auto framing and person tiling functions via remote control only after activating this function.

### To activate the functions for remote control:

- ▶ In the Control Cockpit, navigate to **Devices > TC Bar > Camera**.
- ▶ In the field **Remote Button Control Config**, activate the desired function in order to be able to call it up via remote control.

✓ The functions were activated for remote control.



## Enabling auto framing

The **Auto framing** function focuses on participating people in the room and guarantees this focus at all times.

- i** The **Auto Framing** function can be activated and deactivated only by remote control. For this to be possible, the output function for remote control must be activated using the Control Cockpit (see [Activating the functions for remote control](#)).

### To activate auto framing:

- ▶ Briefly press the **Auto Framing** button on the remote control.
- ✓ The camera LED switches to the following display:

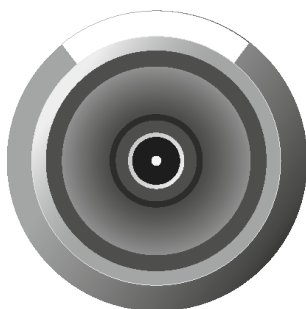

- ✓ Auto framing has been activated.



## Enabling person tiling

The **Person tiling** function records all participating people in the room during a conference and provides the video signal in a form that is suitable for the far end.

- i** The **Person Tiling** function can be activated and deactivated only by remote control. For this to be possible, the output function for remote control must be activated using the Control Cockpit (see [Activating the functions for remote control](#)).

### To enable person tiling:

- ▶ Briefly press the **Person Tiling** button on the remote control.
- ✓ The camera LED switches to the following display:

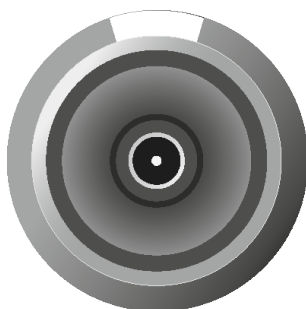

- ✓ Person tiling has been enabled.



## Setting default camera mode

Set a persistent default camera mode so the device always starts in the selected mode, ensuring a consistent experience without manual adjustments, even after a reboot or wake-up.

You can configure a persistent default camera mode, which will be applied before starting a call. During an active call, you can change the camera mode temporarily using the IR remote. These changes apply only to the current session and do not modify the configured default.

After the call ends or the device restarts, the system reverts to the stored default camera mode.

### To set up a default camera mode:

- ▶ In the Control Cockpit, navigate to **Devices > TC Bar > Camera**.
- ▶ Click the drop-down list under **Default Camera Mode**.
- ▶ Choose between the displayed modes:
  - **Resume Last View (Default)**: In this mode, the last saved changes will be applied.
  - **Full Field of View**: Displays the entire field of view.
  - **Auto Framing**: Focuses on participants in the room and maintains this focus at all times.
  - **Person Tiling**: Automatically divides recorded participants into individually tailored frames.
  - **User Preset**: All user configured camera settings will be applied.

✓ The default camera mode has been set.



## Resetting camera settings

You can reset all camera settings to the factory settings.

### To reset all camera settings:

- ▶ In the Control Cockpit, navigate to **Devices > TC Bar > Camera**.
- ▶ Slide the controller for **Camera Reset** to the right and confirm with **OK**.

✓ All camera settings were reset to the factory settings.



## Access

Here you can manage third-party access and device access.

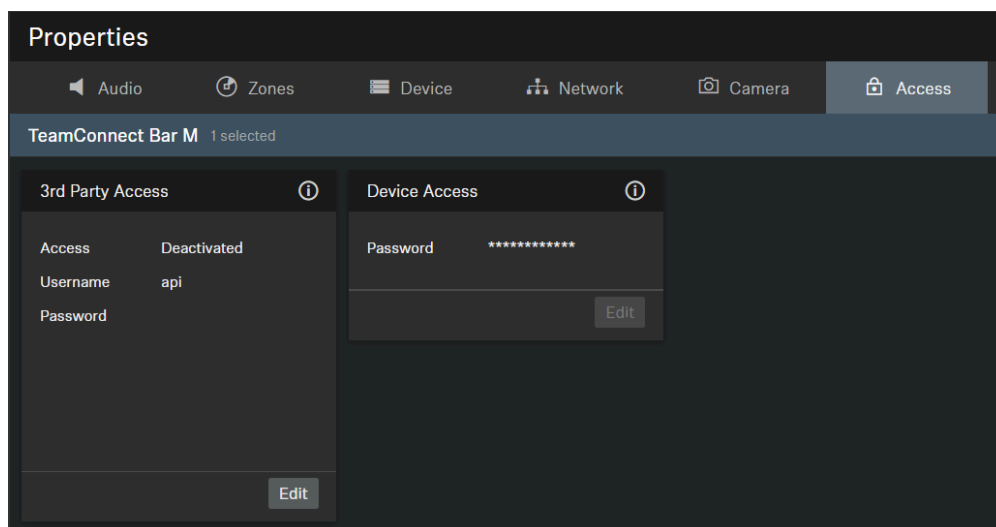

### Third-Party Access

The 3rd party media control access for TeamConnect Bar is encrypted and protected using username and password. It has to be enabled using Control Cockpit before use.

**i** The full range of functions and list of callable methods can be found in the media control protocol for the TeamConnect Bar ([see 3rd party for TeamConnect Bar](#)).

- Enables or disables 3rd party media control access. In order to enable, select the **Edit** button, activate the toggle switch, enter a 3rd party device password and select the **OK** button.
- You can use the username **api** and configured password for your API calls.

**i** If you deactivate 3rd party access, the previously set password will be deleted.

**i** Please note that the new password must meet the following requirements:

- At least ten characters
- At least one lowercase letter
- At least one uppercase letter
- At least one number
- At least one special character: !#\$%&()\*+,-./:;<=>@[^\_{}~
- Maximum length: 64 characters



## Device Access

Changes the password for device access, used by Control Cockpit to authenticate to the device.

**i** Please note that the new password must meet the following requirements:

- At least ten characters
- At least one lowercase letter
- At least one uppercase letter
- At least one number
- At least one special character: !#\$%&()\*+,-./:;<=>@[ ]^\_{}~
- Maximum length: 64 characters

## Activating third-party access

The TC Bar can be accessed by third-party applications via a media control protocol.

To do this, third-party access must be activated in the [control software](#) and protected using a password.

**i** Please refer to the media control protocol for the TC Bar to obtain the complete range of functions and list of methods that can be called up. The general description for using third-party applications and product-specific API documentation can be found on the API documentation for Sennheiser products website ([3rd Party API for Sennheiser products](#)).

### To activate third-party access:

- ▶ Open your control software and navigate to:

Local Web UI	<b>Access &amp; Security.</b>
DeviceHub	<b>Devices &gt; TC Bar &gt; Network.</b>
Control Cockpit	<b>Devices &gt; TC Bar &gt; Access.</b>

- ▶ In the field **3rd Party Access**, click on:
- ▶ In the field **Access**, set the switch to **Activated** (Control Cockpit only).
- ▶ Assign an access password, which is requested by a media control system during device authentication.



**i** Please note that the new password must meet the following requirements:

- At least ten characters
- One lowercase letter (a...z)
- One uppercase letter (A...Z)
- One number (0...9)
- One special character (!#\$%&()\*+,- ./:;<=>@[ ]^\_{}~)
- Maximum length: 64 characters

▶ Click **OK** to save the settings.

✓ Third-party access has been activated.



## Activating device access

You can change the password for accessing the device.

### To change the password for accessing the device:

- ▶ In the Control Cockpit, navigate to **Devices > TC Bar > Access**.
- ▶ In the field **Device Access**, click **Edit**.
- ▶ Assign an access password, which is queried during instance claiming in the Control Cockpit (see [Claiming the TC Bar for a specific Control Cockpit instance \(network solution\)](#)).

**i** Please note that the new password must meet the following requirements:

- At least ten characters
- One lowercase letter (a...z)
- One uppercase letter (A...Z)
- One number (0...9)
- One special character (!#\$%&()\*+,- ./:;<=>@[ ]^\_{}~)
- Maximum length: 64 characters

- ▶ Click **OK** to save the settings.

✓ The password for device access was changed.



## Product care

Fundamental care and maintenance practices to help ensure the longevity and proper functioning of the device.

## Cleaning and maintenance

Note the following information when cleaning and maintaining the product.

### ATTENTION



#### Liquids can damage the electronics of the product

Liquids entering the product housing can cause a short-circuit and damage the electronics.

- ▶ Keep all liquids away from the products.
  - ▶ Do not use any solvents or cleansing agents.
  - ▶ Disconnect the mains-operated products from the power supply system and remove rechargeable batteries and batteries (if present) before you begin cleaning.
  - ▶ Clean all products only with a soft, dry cloth.
- 
- ▶ Clean the products only with a soft, dry cloth.
  - ▶ Disconnect the products from the power supply system and remove any (rechargeable) batteries before you begin cleaning.



## Replacing remote control batteries

You can replace the AAA 1.5 V batteries on your own (see the chapter [Preparing the remote control](#)).



## Storing accessories

You can store both the remote control and the lens cap in the bracket.

The bracket was developed to store the remote control and lens cap safely in one place. This ensures that the accessories are together in one place and immediately at hand for use.

Both the remote control and the lens cap contain magnets by which the accessories adhere to the bracket.

The bracket can be placed on a workstation or securely mounted on a wall (see [Mounting the accessories bracket](#)).

### DANGER



#### Danger due to the influence of magnetic fields

Magnets may affect the function of cardiac pacemakers and implanted defibrillators.

- ▶ Always maintain a distance of at least 10 cm/4" between the product and the cardiac pacemaker or implanted defibrillator (ICDs) or other implants, as the product generates permanent magnetic fields.
- ▶ Warn people who have such devices that they are approaching magnets.



**To safely store the accessories:**

- ▶ First place the lens cap and then the remote control in the appropriate recesses in the bracket.



- ✓ The lens cap and remote control adhere to the bracket magnetically.

✓ The accessories are safely stored.



## Transport

Here you will find information about properly preparing the TC Bar for transport.

If the TC Bar is to be transported, the device must be packaged only in its original box. Also note that the device may store sensitive personal data during usage of the Sennheiser Control Cockpit or other third-party applications.

- i** Please note that you are responsible for securely deleting the data if the TC Bar is sold/passed on or disposed of in order to preclude misuse of the data. You can find additional information on deleting personal data in the chapter [Resetting the TC Bar to factory settings](#).

### ATTENTION



#### Material damage from improper transport

Incorrect packing of the product for transport may result in damage.

- ▶ Only transport the product in its original packaging.

- ▶ Pack the TC Bar in its original packaging for transport.
- ▶ Close the packaging so that it cannot open on its own during transport.
- ▶ Carefully transport the TC Bar in the packaging.



## 4. Knowledge base





Central hub for information, resources, and guides with further content on the product and/or service.

This page provides an overview of all additional information such as guides, know-how, best practices, and further links related to the product.

### Helpful links

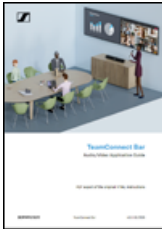
- [3rd Party API for Sennheiser products](#)
- [sennheiser.com/devicehub](https://sennheiser.com/devicehub)
- [sennheiser.com/control-cockpit](https://sennheiser.com/control-cockpit)

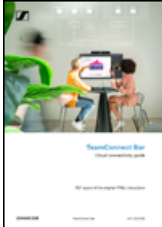
### PDF downloads

Download	Document
	<p><b>Audio/video application guide</b></p> <p>This guide provides technical guidance for planning, configuring, and operating TeamConnect Bar systems in audio/video conferencing environments.</p>
	<p><b>Network guide for system integrators</b></p> <p>This document is intended for system integrators and room planners and serves as a planning guide for the network integration of the TeamConnect Bar (TC Bar) in a room.</p>
	<p><b>Cloud connectivity guide</b></p>
	<p><b>Security white paper</b></p> <p>This white paper aims to provide IT professionals with an in-depth understanding of the TC Bar, its components, and its security features.</p>



## FAQ

The most frequent questions and answers summarized in a chapter.

### What is the difference between TC Bar S and TC Bar M?

The biggest difference between them is their intended meeting room sizes. These devices were conceived for the following:

- TC Bar S: Small meeting rooms (3 m x 4.5 m (10 ft x 15 ft)) for up to 7 people
- TC Bar M: Small to medium meeting rooms (4.5 m x 6 m (15 ft x 20 ft)) for up to 12 people

### How does the initial configuration of the TC Bar work?

#### Stand-alone solution

- As a stand-alone solution, the TC Bar is directly connected with a device and operated using only a USB-C® connection. Only restricted functions are available in this operating mode (see [Operation as a stand-alone solution](#)).
- You can use the embedded local WebUI (firmware version  $\geq 2.0.0$ ) to quickly and easily configure and control your device.

#### Network solution

- As a unit in the network, the TC Bar can be initially assigned to a control instance and managed via the respective application for seamless integration into your corporate network (see [Control software](#) and [Operation as a networked conference system](#)).

### Is it possible to save the camera position?

Yes, the camera position can be saved and called up again:

Press the **Preset** button on the remote control for at least 3 seconds.



Briefly press the **Preset** button to move the camera to the saved position.

You can find more information in the chapter [Setting the camera position](#).

### How does the beamforming technology work?

Both person tiling and auto framing work using advanced video AI algorithms.

With person tiling, each member of a meeting is placed in the center and in the foreground and receives their own tile in the meeting. As soon as the camera detects a participant, they receive their own tile. As a result, even people in the back row are placed in the foreground and appear very close to the participants who are connected.

Auto framing ensures that all participants remain in the field of view, even if they move around in the room – whether they shift their chairs slightly or get up to move around the room.

You can find more information in the chapter [Camera settings](#).

### What connectivity does the TC Bar have?

- USB-C® (main connection for the conference system)
- USB-A (connection for an external PTZ camera)
- RJ45 (Ethernet/control/Dante®)
- HDMI® (connection for screen output)
- DC IN (connection for the power supply)
- Bluetooth®

You can find more information in the chapter [Connectivity](#).

### Is there an analog audio output?

No.



### Is it possible to change the LED brightness?

Yes, the setting can be configured in the Sennheiser control software.

### What mounting options are there for this product?

There are various mounting options for attaching and positioning the TC Bar in a room:

- [Mounting on the wall](#) (bracket included in the scope of delivery)
- [Mounting on the table](#) (bracket included in the scope of delivery)
- [Mounting on a VESA mount](#) (optional accessories required, see [Accessories](#))
- [Mounting on a tripod](#) (bracket included in the scope of delivery, but not the tripod)

You can find more information in the chapter [Mounting options](#).

### Which audio options are available for Bluetooth®, USB, and HDMI®?

Essentially, bidirectional audio is available (special audio profile for playing music).

- **Bluetooth®:**
  - With Bluetooth®, mobile devices (e.g., smartphones) use two different codecs: the HFP and the A2DP codec. The HFP codec is optimized for voice and conference sound and the A2DP codec for music applications.
- **USB:**
  - In USB applications, a specific EQ of the TC Bar distinguishes between conference and music playback..
- **HDMI®:**
  - HDMI® does not support any audio, since the TC Bar itself is used as an audio device. The connection serves only to transmit the video signal to an external screen.

### What network options are available for the TC Bar?

The TC Bars are in the following network modes in the factory settings:

- TC Bar S: Single domain mode
- TC Bar M: Split mode
- The TC Bar S has only one network connection and can provide only a combined signal for Dante® and control. That is why a switch is required in this configuration to connect all devices on which the control software is running via a control network and to connect additional Sennheiser microphones via a Dante® network.
- The TC Bar M has two network connections. One connection can be used to control the bar through the network using the Dante controller and through control software directly using a switch. The other port is used to connect an additional Sennheiser microphone via the Dante® network (e.g., TCC M). Only an Ethernet cable is required for this purpose. The TCC M can then be controlled using the same network via the control software or the Dante controller.



Additional configuration options are explained in the chapter [Network configuration](#).

### **Is it possible to separate the Dante® and Control networks? ?**

Yes. Since both TC Bars are different, the following must be observed:

- TC Bar M:
  - Since the TC Bar M has two network connections, you can separate the networks physically by activating the network mode **Split mode**. This mode is the same for MCR and TCC M.
- TC Bar S:
  - Since the TC Bar S has only one network connection, the Dante® network and control network must be separated virtually via VLAN tagging. This can be done by selecting the mode “Dual domain mode” in the control software.

Additional configuration options are explained in the chapters [Network configuration](#) and [Activating tagged VLAN \(Dante® network\)](#).

### **Are some functions deactivated in the factory settings for security reasons?**

Yes, Bluetooth® and Wi-Fi (not yet available) have to be activated in the control software (see [Activating Bluetooth®](#)).

### **Can I connect an additional camera?**

Yes, it is possible to connect an external PTZ camera from a third-party provider directly to the TC Bar using the USB-A connection. In this case, the user can select either the TC Bar’s internal camera or the external PTZ camera for an additional whiteboard or presenter view. There is no smart camera switching.

### **Which USB cameras can I connect?**

Since there is a USB hub in the TC Bar, the connection functions like a direct connection to the laptop/PC. Therefore, any PTZ camera can be connected. The configuration and selection must take place from the device.

### **Can I use my own DSP instead of a third-party DSP for ceiling microphones?**

Yes, if a ceiling microphone is connected to a TC Bar, no additional DSP is required. The TC Bar has an integrated auto mixing and multi-AEC function (acoustic echo compensation).

### **Does the TC Bar have an automatic echo suppression function (AEC)?**

Yes. Thanks to external microphone connections, the TC Bar has a multi-echo-suppression function.



### **Is there a remote control? And if so, are the functions contained in media control systems like Creston, Extron, etc.?**

Yes, an IR (infrared) remote control is available and included in the scope of delivery. Not all commands for the remote control are available for media control systems yet. However, they will be provided in a future update.

### **Does the TC Bar support the beamforming feature?**

Yes. The bars have a linear microphone array with 23 static beams. Depending on the direction from which a speaker is detected, the beam that can record the speaker best is selected. If an additional speaker is detected from another direction, the algorithm automatically switches the beams.

### **How does the TC Bar work if it is only connected via USB and power supply?**

If the TC Bar is supplied with power and connected to a laptop via a USB, it can be used directly as an audio and video conference device in BYOD (bring your own device) mode. In the default mode, some functions such as Bluetooth® and Wi-Fi are deactivated. They can be activated in the Sennheiser control software.

### **Does the TC Bar save personal data?**

This product has an integrated memory and can store sensitive personal data that was added in the context of the Control Cockpit software or other third-party applications.

### **How can I delete my personal data?**

You can permanently delete your personal data by resetting the device to the factory settings (see the chapter [Resetting the TC Bar to factory settings](#)).

### **What is the DisplayLink® technology?**

With DisplayLink®, you can quickly and easily connect several monitors to your PC using a simple USB connection. The DisplayLink® technology is integrated in the TC Bar and does not require an additional HDMI® cable from your PC to your TV screen.

### **Do I need a DisplayLink® driver on my video conference device?**

Yes. It is installed by default on Windows® PCs. Check whether the minimum required version of the DisplayLink® driver is installed on all users PCs involved in order to be able to use the plug & play function for joint usage of the screen.

It is possible that no DisplayLink® driver is installed by default on Mac devices, since Apple is a closed system. In this case, the minimum required DisplayLink® driver version must be installed as indicated below.



### **Which DisplayLink® driver version do I need?**

- Windows®: 10 or newer
- macOS: 13 or newer
- Android: 11.0 or newer
- Installed DisplayLink® driver on the operating system used

You can find information about the latest driver for the operating system you use at: [DisplayLink®](#).

### **What does the repair process look like? Are there service parts?**

The TC Bar is designed as a repairable product in order to fulfill the requirements of a sustainable service concept. We have several replacement parts and special service tools that can be used to replace parts and return the device to a flawless condition.

The TC Bars are maintained in our service centers, which are located around the world. It may be necessary to send the product to one of these service centers for maintenance.



## 5. Specifications

All specifications at a glance.

The following pages contain detailed information about the specifications of the TC Bar S and M, as well as the power supply units and remote control included in the delivery.

### Specifications - TC Bar S

#### General

##### Dimensions (LxWxH)

- 450 × 71 × 76 mm

##### Weight:

- 1.5 kg

##### Temperature range

- During use: 0 °C to +40 °C (32 °F to 104 °F)
- Storage: -25 °C to +70 °C (-13 °F to 158 °F)

##### Relative humidity

- During use: 0% to 75%, non-condensing
- Storage: 0% to 95%, non-condensing

##### Power supply

- 15 V DC, maximum 2 A

##### Maximum power consumption

- 30W

##### PoE+ (PD) voltage range

- 42.5 – 57.0 V DC (IEEE 802.3at type 2, PoE+)

#### Speakers

##### Number of speakers installed

- Two broadband speakers with passive membrane



#### **Diameter**

- 50 mm

#### **Maximum sound pressure level (out)**

- 80 dB SPL

#### **Audio output power (RMS/PEAK)**

- 10 W/20 W

#### **Microphones**

##### **Transducer principle**

- MEMS

##### **Pick-up pattern**

- Beamforming array

##### **Frequency response**

- 100 Hz to 14.5 kHz

#### **Camera**

##### **Zoom**

- Certified: 2 x digital zoom (Microsoft Teams)
- Optional: 3 x digital zoom

##### **Diagonal field of view**

- 120°

##### **Horizontal field of view**

- 115°

#### **Connections**

##### **HDMI**

- HDMI ®

##### **USB-C**

- USB 3.1 (gen 1)



**USB-A**

- USB 3.1 (gen 1) 5 V DC, maximum 900 mA

**Ethernet**

- 1 x 1000/100/10 Mbit/s (RJ45)

**DC input dimensions**

- 5.5 × 2.1 × 10.5 mm

**TC Bar S power supply unit**

**Model:**

- S050-1A150300M2

**Dimensions (LxWxH)**

- 108 × 52 × 34 mm

**Weight**

- 300 g

**Input**

- (AC) 100-240 V AC, 50/60 Hz, 1.5 A

**Output**

- (DC) 15 V DC, maximum 3 A, 45 W

**AC connector**

- 2-pin

**DC output dimensions**

- 5.5 × 2.1 × 11 mm

**Relative humidity - operation**

- 20% to 98%, non-condensing

**Relative humidity - storage**

- 20% to 98%, non-condensing



**Operating temperature**

- 0 °C to 40 °C or 32 °F to 104 °F

**Storage temperature**

- -40 °C to 80 °C or -40 °F to 176 °F

Bar M mounting kit

**Dimensions (LxWxH)**

- 199 × 62 × 74 mm

**Weight**

- Approx. 340 g

**Wi-Fi**

**Standard**

- IEEE 802.11a /b /g /n /ac

**Transmission system**

- SISO (single in, single out)

**Frequency range (maximum RF output power)**

- 2412 MHz – 2472 MHz (max. 20 dBm RF output power) 5150 MHz – 5350 MHz (maximum 23 dBm RF output power) 5470 MHz – 5725 MHz (maximum 23 dBm RF output power) 5725 MHz – 5850 MHz (maximum 14 dBm RF output power)

**Modulation**

- 64QAM, 16QAM, QPSK, BPSK, CCK, DQPSK, DBPSK

**Bluetooth®**

**Version**

- 5.1

**Frequency range**

- 2402 MHz - 2480 MHz

**Modulation**

- GFSK,  $\pi/4$  DQPSK, 8DPSK



**Profiles**

- A2DP, HFP, AVRCP

**RF output power**

- 10 dBm

**Codec**

- SBC



## Specifications - TC Bar M

### General

#### Dimensions (LxWxH)

- 750 × 71 × 95 mm

#### Weight:

- 2.5 kg

#### Temperature range

- During use: 0 °C to +40 °C (32 °F to 104 °F)
- Storage: -25 °C to +70 °C (-13 °F to 158 °F)

#### Relative humidity

- During use: 0% to 75%, non-condensing
- Storage: 0% to 95%, non-condensing

#### Power supply

- 18 V DC, maximum 4 A

#### Maximum power consumption

- 72 W

### Speakers

#### Number of speakers installed

- Four broadband speakers with passive membrane

#### Diameter

- 50 mm

#### Maximum sound pressure level (out)

- 84 dB SPL

#### Audio output power (RMS/PEAK)

- 20 W/40 W



## Microphones

### Transducer principle

- MEMS

### Pick-up pattern

- Beamforming array

### Frequency response

- 100 Hz to 14.5 kHz

## Camera

### Zoom

- Certified: 1.5 x digital zoom (Microsoft Teams)
- Optional: 5 x digital zoom

### Diagonal field of view

- 120°

### Horizontal field of view

- 115°

## Connections

### HDMI 1

- HDMI®

### HDMI 2

- HDMI®

### USB-C

- USB 3.1 (gen 1)

### USB-A

- USB 3.1 (gen 1) 5 V DC, maximum 900 mA

### Ethernet

- 2 x 1000/100/10 Mbit/s (RJ45)



**DC input dimensions**

- 5.5 × 2.1 × 10.5 mm

**TC Bar M power supply unit**

**Model:**

- E096-1A180500B3

**Dimensions (LxWxH)**

- 148 × 60 × 34 mm

**Weight**

- 600 g

**Input**

- (AC) 100-240 V AC, 50/60 Hz, 1.5 A

**Output**

- (DC) 18 V DC, maximum 5 A, 90 W

**AC connector**

- 3-pin

**DC output dimensions**

- 5.5 × 2.1 × 11 mm

**Relative humidity - operation**

- 20% to 98%, non-condensing

**Relative humidity - storage**

- 20% to 98%, non-condensing

**Operating temperature**

- 0 °C to 40 °C or 32 °F to 104 °F

**Storage temperature**

- -40 °C to 80 °C or -40 °F to 176 °F

Bar M mounting kit



#### **Dimensions (LxWxH)**

- 268 × 66 × 86 mm

#### **Weight**

- Approx. 520 g

#### **Wi-Fi**

##### **Standard**

- IEEE 802.11a /b /g /n /ac

##### **Transmission system**

- SISO (single in, single out)

##### **Frequency range (maximum RF output power)**

- 2412 MHz – 2472 MHz (max. 20 dBm RF output power) 5150 MHz – 5350 MHz (maximum 23 dBm RF output power) 5470 MHz – 5725 MHz (maximum 23 dBm RF output power) 5725 MHz – 5850 MHz (maximum 14 dBm RF output power)

##### **Modulation**

- 64QAM, 16QAM, QPSK, BPSK, CCK, DQPSK, DBPSK

#### **Bluetooth®**

##### **Version**

- 5.1

##### **Frequency range**

- 2402 MHz - 2480 MHz

##### **Modulation**

- GFSK,  $\pi/4$  DQPSK, 8DPSK

##### **Profiles**

- A2DP, HFP, AVRCP

##### **RF output power**

- 10 dBm



**Codec**

- SBC



## Specifications - RC TC Bar remote control

### General

#### Transmission

- Infrared

#### Range

- Approx. 6 m

#### Power supply

- 2 AAA batteries, 1.5 V (zinc-carbon)

#### Dimensions

- (LxWxH): 126 × 40 × 14 mm

#### Weight

- Remote control
  - 60 g (incl. batteries)
- Bracket
  - 160 g

#### Temperature range

- -10 °C to 50 °C or 14 °F to 122 °F



## 6. Regulatory information

Information on manufacturer declarations, environmental and disposal notices, and terms of use.

Model: TC Bar S, TC Bar M, RC TC Bar, Power Supply TC Bar S (Model: S050-1A150300M2), Power Supply TC Bar M (Model: E096-1A180500B3)

### Warranty

Sennheiser electronic SE & Co. KG gives a warranty of 24 months on these products.

For the current warranty conditions, please visit our website at [sennheiser.com](http://sennheiser.com) or contact your Sennheiser partner.

In the US please contact:

Sennheiser Electronic Corporation

1 Enterprise Drive, Old Lyme, CT 06371

[www.sennheiser.com](http://www.sennheiser.com)

### Warranty for Australia and New Zealand only

Sennheiser Australia Pty Ltd provides a warranty of 24 months on these products. For the current warranty conditions, visit Sennheiser website: Australia: [sennheiser.com](http://sennheiser.com), New Zealand: [sennheiser.com](http://sennheiser.com)

Sennheiser goods come with guarantees that cannot be excluded under Australian and New Zealand Consumer law. You are entitled to a replacement or refund for a major failure and compensation for any other reasonably foreseeable loss or damage. You are also entitled to have the goods repaired or replaced if the goods fail to be of acceptable quality and the failure does not amount to a major failure.

This warranty is in addition to other rights or remedies under law. Nothing in this warranty excludes, limits or modifies any remedy available to be consumer which is granted by law.

To make a claim under this contract, raise a case via Sennheiser website. Australia: [sennheiser.com/support](http://sennheiser.com/support), New Zealand: [sennheiser.com/support](http://sennheiser.com/support)

All expenses of claiming the warranty will be borne by the person making the claim.

Sennheiser international warranty is provided by: Sennheiser Australia Pty Ltd (ABN 68 165 388 312) Level 14, Tower A Zenith Building, 821 Pacific Highway, Chatswood NSW 2067, Australia

### Notes on disposal

The symbol of the crossed-out dumpster on the product, the (rechargeable) battery (if applicable) and/or the packaging indicates that these products must not be disposed of



with normal household waste, but must be disposed of separately at the end of their service life. For the packaging, follow the regulations in your country for separating waste. Improper disposal of packaging materials can be harmful to your health and the environment.

The separate collection of waste electrical and electronic equipment, (rechargeable) batteries (if applicable) and packaging is intended to promote reuse and recycling and to prevent negative impacts on public health and the environment, for example due to hazardous substances contained in these products. At the end of their service life, recycle electrical and electronic equipment and (rechargeable) batteries so that their materials can be reused and to prevent environmental pollution.

If (rechargeable) batteries can be removed without destroying them, you are obliged to dispose of them separately (see the product's operating instructions for information on how to remove the batteries safely). Be especially careful when handling (rechargeable) batteries containing lithium, as these pose special hazards, such as the risk of fire and/or health risks if button cells are swallowed. Reduce battery waste as much as possible by using longer-life batteries or rechargeable batteries.

Further information on the recycling of these products can be obtained from your municipal administration, from the municipal collection points, or from your Sennheiser partner. You may also be able to return electrical or electronic equipment to your distributor, if they are legally required to do so. By disposing of your batteries properly, you are helping to protect public health and the environment.

### TC Bar S | TC Bar M

Information on manufacturer declarations, environmental and disposal notices, and terms of use.

Model: TC Bar S, TC Bar M

#### Notes on personal data

This product with integrated data storage may contain sensitive personal data.

Please note that you are responsible for the secure deletion of data in order to prevent data misuse if the product is sold/passed on or disposed of.

#### Europe



In compliance with the following requirements



- Regulation (EU) 2023/988 on general product safety
- WEEE Directive (2012/19/EU)
- Regulation (EU) 2023/1542 concerning batteries and waste batteries



**Italy:**

Raccolta carta



Raccolta plastica



**France:**



**FR**

- + Carton d'emballage
- + Notices d'emploi en papier
- + Sac plastique PE
- + Film rétractable PET



Privacy notice for integrated camera and microphone

This device includes a camera and microphone to support audio/video conferencing.

Please note:

No Recording or Storage: This device does not have any functionality for recording or storing image or audio data. All data is processed in real time solely to enable the intended features.

Data Captured: When the microphone and/or camera are active, audio and image data may be captured. These may be considered personal data if they can be linked to your identity (e.g., voice, facial features).

Purpose of Processing: Data is processed exclusively to provide real-time functionalities such as voice interaction or video communication. No profiling, analysis, or data sharing takes place.

**EU Declaration of conformity**

- RoHS Directive (2011/65/EU)

Hereby, Sennheiser electronic SE & Co. KG declares that the radio equipment type TC Bar S | TC Bar M is in compliance with Directive 2014/53/EU.

The full text of the EU declaration of conformity is available at the following internet address: [sennheiser.com/download](https://sennheiser.com/download).



## United Kingdom



### In compliance with the following requirements

- WEEE Regulations (2013)
- Battery Regulations (2015)



### UK Declaration of conformity

- RoHS Regulations (2012)
- Radio Equipment Regulations (2017)

Importer: Sennheiser UK Ltd.

Pacific House, Third Avenue, Globe Park, Marlow

Buckinghamshire SL7 1EY, United Kingdom

## USA



TC Bar S: FCC ID: DMOTCBAR

TC Bar M: FCC ID: DMOTCBARM

### Statements regarding FCC and ISED

This device complies with Part 15 of the FCC rules, RSS-247 of Innovation, Science and Economic Development Canada (ISED). Operation is subject to the following two conditions:

- 1) This device may not cause harmful interference, and
- 2) This device must accept any interference received, including interference that may cause undesired operation.

The device for operation in the band 5150-5250 MHz is only for indoor use to reduce the potential for harmful interference to co-channel mobile satellite systems.

Where applicable, antenna type(s), antenna models(s), and worst-case tilt angle(s) necessary to remain compliant with the e.i.r.p. elevation mask requirement set forth in section 6.2.2.3 shall be clearly indicated.

This equipment has been tested and found to comply with the limits for a Class B digital device, pursuant to part 15 of the FCC Rules. These limits are designed to provide reasonable



protection against harmful interference in a residential installation. This equipment generates, uses and can radiate radio frequency energy and, if not installed and used in accordance with the instructions, may cause harmful interference to radio communications. However, there is no guarantee that interference will not occur in a particular installation. If this equipment does cause harmful interference to radio or television reception, which can be determined by turning the equipment off and on, the user is encouraged to try to correct the interference by one or more of the following measures:

- Reorient or relocate the receiving antenna.
- Increase the separation between the equipment and receiver.
- Connect the equipment into an outlet on a circuit different from that to which the receiver is connected.
- Consult the dealer or an experienced radio/ TV technician for help.

Changes or modifications not expressly approved by Sennheiser electronic Corp. could void the user's authority to operate the equipment.

### **Radiofrequency radiation exposure Information**

This device meets FCC/ ISED RF exposure guidelines for an uncontrolled environment. Use of other accessories not verified by the manufacturer may not ensure compliance with FCC / ISED RF exposure guidelines. The equipment should be installed and operated with minimum distance 20 cm between the radiator and your body.

This transmitter must not be co-located or operated in conjunction with any other antenna or transmitter.

Contact information: Sennheiser Electronic Corporation, 1 Enterprise Drive, Old Lyme, CT 06371; [sennheiser.com](http://sennheiser.com)

### **Canada**

CAN ICES3(B)/NMB3(B)

TC Bar S: IC: 2099A-TCBAR

TC Bar S: IC: 2099A-TCBARM

### **Statements regarding FCC and ISED**

This device complies with Part 15 of the FCC rules, RSS-247 of Innovation, Science and Economic Development Canada (ISED). Operation is subject to the following two conditions:

- 1) This device may not cause harmful interference, and
- 2) This device must accept any interference received, including interference that may cause undesired operation.

The device for operation in the band 5150-5250 MHz is only for indoor use to reduce the potential for harmful interference to co-channel mobile satellite systems.



Where applicable, antenna type(s), antenna models(s), and worst-case tilt angle(s) necessary to remain compliant with the e.i.r.p. elevation mask requirement set forth in section 6.2.2.3 shall be clearly indicated.

This equipment has been tested and found to comply with the limits for a Class B digital device, pursuant to part 15 of the FCC Rules. These limits are designed to provide reasonable protection against harmful interference in a residential installation. This equipment generates, uses and can radiate radio frequency energy and, if not installed and used in accordance with the instructions, may cause harmful interference to radio communications. However, there is no guarantee that interference will not occur in a particular installation. If this equipment does cause harmful interference to radio or television reception, which can be determined by turning the equipment off and on, the user is encouraged to try to correct the interference by one or more of the following measures:

- Reorient or relocate the receiving antenna.
- Increase the separation between the equipment and receiver.
- Connect the equipment into an outlet on a circuit different from that to which the receiver is connected.
- Consult the dealer or an experienced radio/ TV technician for help.

Changes or modifications not expressly approved by Sennheiser electronic Corp. could void the user's authority to operate the equipment.

### **Radiofrequency radiation exposure Information**

This device meets FCC/ ISED RF exposure guidelines for an uncontrolled environment. Use of other accessories not verified by the manufacturer may not ensure compliance with FCC / ISED RF exposure guidelines. The equipment should be installed and operated with minimum distance 20 cm between the radiator and your body.

This transmitter must not be co-located or operated in conjunction with any other antenna or transmitter.

Contact information: Sennheiser Electronic Corporation, 1 Enterprise Drive, Old Lyme, CT 06371; [sennheiser.com](http://sennheiser.com)

### **Australia / New Zealand**



### **Japan**

TC Bar S:



TC Bar M:



### Brazil



TC Bar S: 07022-23-07356

TC Bar M: 10593-23-07356

### India

IS 13252 (Part 1):2010  
/ IEC 60950-1:2005



R-41256072  
[www.bis.gov.in](http://www.bis.gov.in)

### Indonesia

TC Bar S:

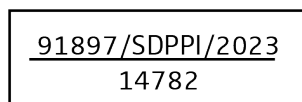

TC Bar S:

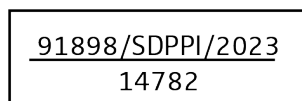



**Mexico**



TC Bar S: IFT: SESETC23-05744

TC Bar M: IFT: SESETC23-14660

**South Korea**



**TC Bar S:** #####: Sennheiser electronic SE & Co. KG

#####: TeamConnect Bar

###: TC Bar S

###: ##

R-R-SE9-TCBAR

**TC Bar M:** #####: Sennheiser electronic SE & Co. KG

#####: TeamConnect Bar

###: TC Bar M

###: ##

R-R-SE9-TCBAR

**Singapore**

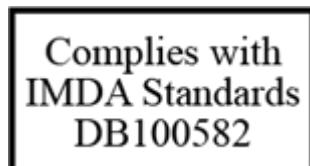



## China

China RoHS 

设备名称：TeamConnect Bar, 型号名称：TC Bar S / TC Bar M							
部件名称 (Parts)	有害物质						产品环保年限 EFUP
	铅 (Pb)	汞 (Hg)	镉 (Cd)	六价铬 (Cr6+)	多溴联苯 (PBB)	多溴二苯醚 (PBDE)	
金属部件 (Metal parts)	x	o	o	o	o	o	15
电路模块 (Circuit Modules)	x	o	o	o	o	o	15
电缆及电缆组件 (Cables & Cable Assemblies)	x	o	o	o	o	o	15
遥控 (Remote Control)	x	o	o	o	o	o	15

本表格依据 SJ/T 11364 的规定编制。  
o: 表示该有毒有害物质在该部件所有均质材料中的含量均在GB/T 26572 标准规定的限量要求以下。  
x: 表示该有毒有害物质至少在该部件的某一均质材料中的含量超出GB/T 26572 标准规定的限量要求。

TC Bar S: CMIIT ID: 2023AJ2978

 CCAJ23LP0CD0T0

TC Bar M: CMIIT ID: 2023AJ6523

 CCAJ23LP19B0T7



## Remote control RC TC Bar

Information on manufacturer declarations, environmental and disposal notices, and terms of use.

Model: RC TC Bar

### Europe



In compliance with the following requirements

- Regulation (EU) 2023/988 on general product safety
- WEEE Directive (2012/19/EU)
- Regulation (EU) 2023/1542 concerning batteries and waste batteries



Italy:

Raccolta carta



Raccolta plastica

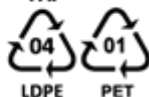

France:



**FR**

- + Carton d'emballage
- + Notices d'emploi en papier
- + Sac plastique PE
- + Film rétractable PET

### EU Declaration of conformity

- RoHS Directive (2011/65/EU)

The full text of the EU declaration of conformity is available at the following internet address: [sennheiser.com/download](https://sennheiser.com/download).



### United Kingdom



- WEEE Regulations (2013)
- Battery Regulations (2015)



### UK Declaration of conformity

- RoHS Regulations (2012)

Importer: Sennheiser UK Ltd.

Pacific House, Third Avenue, Globe Park, Marlow

Buckinghamshire SL7 1EY, United Kingdom

### Australia / New Zealand



### Vietnam

Kể từ ngày 1 tháng 12 năm 2012, các sản phẩm được sản xuất bởi Sennheiser tuân thủ Thông tư 30/2011/TT-BCT quy định về giới hạn cho phép đối với một số chất độc hại trong các sản phẩm điện và điện tử.



China

China RoHS

产品中有毒有害物质或元素的名称及含量标识表 Hazardous Substances Table						
部件名称 (Parts Name)	有毒有害物质或元素 (Hazardous Substances)					
	铅 (Pb)	汞 (Hg)	镉 (Cd)	六价铬 (Cr(VI))	多溴联苯 (PB B)	多溴二苯醚 (PBDE)
线路板 Circuit board	X	○	○	○	○	○
外壳 Shell	○	○	○	○	○	○
电池 Battery	○	○	○	○	○	○
按键 Button	○	○	○	○	○	○

本表格依据SJ/T 11364的规定编制。  
 O: 表示该有害物质在该部件所有均质材料中的含量均在 GB/T 26572规定的限量要求以下。  
 O: Indicates that this hazardous substance contained in all homogeneous materials of this part is below the limit specified in GB/T 26572.  
 X: 表示该有害物质至少在该部件的某一均质材料中的含量超出 GB/T 26572规定的限量要求。  
 X: Indicates that this hazardous substance contained in at least one of the homogeneous materials of this part is above the limit specified in GB/T 26572.



## Power supply

Information on manufacturer declarations, environmental and disposal notices, and terms of use.

Model: Power Supply TC Bar S (Model: S050-1A150300M2), Power Supply TC Bar M (Model: E096-1A180500B3)

### Europe



In compliance with the following requirements

- Regulation (EU) 2023/988 on general product safety
- WEEE Directive (2012/19/EU)



Italy:

Raccolta carta



France:

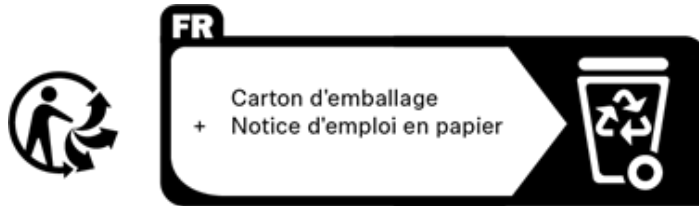

EU Declaration of conformity

- RoHS Directive (2011/65/EU)
- EMC Directive (2014/30/EU)
- Low Voltage Directive (2014/35/EU)

The full text of the EU declaration of conformity is available at the following internet address: [sennheiser.com/download](https://sennheiser.com/download).

United Kingdom





- WEEE Regulations (2013)



#### UK Declaration of conformity

- RoHS Regulations (2012)
- EMC Regulations (2016)
- Electrical Equipment (Safety) Regulations (2016)

Importer: Sennheiser UK Ltd.

Pacific House, Third Avenue, Globe Park, Marlow

Buckinghamshire SL7 1EY, United Kingdom

#### Canada

CAN ICES3(B)/NMB3(B)

#### Australia / New Zealand



Power Supply TC Bar S: SAA-240329-EA

Power Supply TC Bar M: SAA-203343-EA

#### Japan



Sennheiser

ゼンハイザージャパン(株)

#### India

IS 13252 (Part 1)/IEC 60950-1



R-41239623  
www.bis.gov.in



### South Korea



Power Supply TC Bar S: HU10935-22045A; R-R-3NB-S050; A/S Center: 070-4746-7903

Power Supply TC Bar M: HU10935-20032C; R-R-3NB-E0961A; A/S Center: 070-4746-7903

### Vietnam

Kể từ ngày 1 tháng 12 năm 2012, các sản phẩm được sản xuất bởi Sennheiser tuân thủ Thông tư 30/2011/TT-BCT quy định về giới hạn cho phép đối với một số chất độc hại trong các sản phẩm điện và điện tử.

### Taiwan



R3A531 RoHS



Power Supply TC Bar S:



設備名稱：電源供應器 Power Supply TC Bar S ， 型號 (型式)：S050-1A150300M2						
Equipment name:				Type designation(Type):		
單元 Unit	限用物質及其化學符號 Restricted substances and its chemical symbols					
	鉛 Lead (Pb)	汞 Mercury (Hg)	鎘 Cadmium (Cd)	六價鉻 Hexavalent chromium (Cr <sup>6+</sup> )	多溴聯苯 Polybrominated biphenyls (PBB)	多溴二苯醚 Polybrominated diphenyl ethers (PBDE)
外殼	—	○	○	○	○	○
金屬	—	○	○	○	○	○
電路板	—	○	○	○	○	○
電子零件	—	○	○	○	○	○
<p>備考 1. “超出 0.1 wt%” 及 “超出 0.01 wt%” 係指限用物質之百分比含量超出百分比含量基準值。            Note 1: “Exceeding 0.1 wt%” and “exceeding 0.01 wt%” indicate that the percentage content of the restricted substance exceeds the reference percentage value of presence condition.</p> <p>備考 2. “○” 係指該項限用物質之百分比含量未超出百分比含量基準值。            Note 2: “○” indicates that the percentage content of the restrictive substance does not exceed the percentage of reference value of presence</p> <p>備考 3. “—” 係指該項限用物質為排除項目。            Note 3: The “—” indicates that the restricted substance corresponds to the exemption.</p>						

Power Supply TC Bar M:

設備名稱：電源供應器 Power Supply TC Bar M ， 型號 (型式)：E096-1A180500B3						
Equipment name:				Type designation(Type):		
單元 Unit	限用物質及其化學符號 Restricted substances and its chemical symbols					
	鉛 Lead (Pb)	汞 Mercury (Hg)	鎘 Cadmium (Cd)	六價鉻 Hexavalent chromium (Cr <sup>6+</sup> )	多溴聯苯 Polybrominated biphenyls (PBB)	多溴二苯醚 Polybrominated diphenyl ethers (PBDE)
外殼	—	○	○	○	○	○
金屬	—	○	○	○	○	○
電路板	—	○	○	○	○	○
電子零件	—	○	○	○	○	○
<p>備考 1. “超出 0.1 wt%” 及 “超出 0.01 wt%” 係指限用物質之百分比含量超出百分比含量基準值。            Note 1: “Exceeding 0.1 wt%” and “exceeding 0.01 wt%” indicate that the percentage content of the restricted substance exceeds the reference percentage value of presence condition.</p> <p>備考 2. “○” 係指該項限用物質之百分比含量未超出百分比含量基準值。            Note 2: “○” indicates that the percentage content of the restrictive substance does not exceed the percentage of reference value of presence</p> <p>備考 3. “—” 係指該項限用物質為排除項目。            Note 3: The “—” indicates that the restricted substance corresponds to the exemption.</p>						



China



Power Supply TC Bar S:

China RoHS

设备名称： Power Supply TC Bar S ， 型号名称： S050-1A150300M2							
部件名称 (Parts)	有害物质						产品环保年限 EFUP
	铅 (Pb)	汞 (Hg)	镉 (Cd)	六价铬 (Cr6+)	多溴联苯 (PBB)	多溴二苯醚 (PBDE)	
金属部件 (Metal parts)	X	o	o	o	o	o	10
电路模块 (Circuit Modules)	X	o	o	o	o	o	10
电缆及电缆组件 (Cables & Cable Assemblies)	X	o	o	o	o	o	10
外部电力适配器 - 如果包含 (external power supply - if available)	X	o	o	o	o	o	10

本表格依据 SJ/T 11364 的规定编制。  
 o: 表示该有毒有害物质在该部件所有均质材料中的含量均在GB/T 26572 标准规定的限量要求以下。  
 x: 表示该有毒有害物质至少在该部件的某一均质材料中的含量超出GB/T 26572 标准规定的限量要求。

Power Supply TC Bar M:

China RoHS

设备名称： Power Supply TC Bar M ， 型号名称： E096-1A180500B3							
部件名称 (Parts)	有害物质						产品环保年限 EFUP
	铅 (Pb)	汞 (Hg)	镉 (Cd)	六价铬 (Cr6+)	多溴联苯 (PBB)	多溴二苯醚 (PBDE)	
金属部件 (Metal parts)	X	o	o	o	o	o	10
电路模块 (Circuit Modules)	X	o	o	o	o	o	10
电缆及电缆组件 (Cables & Cable Assemblies)	X	o	o	o	o	o	10
外部电力适配器 - 如果包含 (external power supply - if available)	X	o	o	o	o	o	10

本表格依据 SJ/T 11364 的规定编制。  
 o: 表示该有毒有害物质在该部件所有均质材料中的含量均在GB/T 26572 标准规定的限量要求以下。  
 x: 表示该有毒有害物质至少在该部件的某一均质材料中的含量超出GB/T 26572 标准规定的限量要求。

