



Spectera

Bidirectional, wireless broadband ecosystem

PDF export of the original HTML manual



Contents

1. Preface.....	6
2. Quick start.....	7
3. Product information.....	9
Spectera System.....	9
Base Station.....	10
SEK.....	12
DAD.....	13
Accessories.....	14
Accessories for the Base Station.....	14
Accessories for the SEK.....	16
Accessories for the DAD.....	18
CHG 70N-C network-enabled charger.....	19
BA 70 rechargeable battery and L 70 USB charger.....	21
Modular L 6000 charger.....	22
Charging modules for L 6000 charger.....	24
4. Instruction manual	27
Base Station.....	28
Get started.....	28
General information for the System.....	31
Product overview.....	32
Installing slot-in cards.....	34
Connecting/disconnecting the Base Station to/from the power supply system.....	37
Connecting to a network.....	39
Connecting antennas.....	41
Connecting word clock.....	43
Connecting audio via Dante®.....	46
Connecting audio via MAD1.....	49
Changing the fan filter.....	50
Installing the Base Station in a rack.....	52
Switching the Base Station on and into standby.....	54
Activating a license (general).....	55
Using the headphone output.....	57
Meaning of the LED.....	58
Information on the display.....	59



Navigating the menu.....	60
Menu structure.....	61
Updating the Base Station.....	72
SEK.....	73
Product overview.....	73
Inserting and removing the rechargeable battery.....	75
Mounting the antenna.....	78
Using the protection cap.....	79
Connecting a microphone / instrument.....	80
To use the Phones jack.....	83
Changing the belt clip.....	85
Meaning of the LEDs.....	89
Switching the SEK on and off.....	92
Information on the display.....	94
Pairing the SEK to the Base Station.....	98
Updating the SEK.....	99
DAD.....	100
Product overview.....	100
Information on antenna setup.....	101
Meaning of the LED.....	103
Placing on a stand.....	104
Connecting/disconnecting the antenna.....	106
Antenna cable extension.....	109
Updating the DAD.....	110
CHG 70N-C charger.....	111
Product overview.....	111
Connecting/disconnecting the charger to/from the power supply system.....	113
Connecting a charger in a network.....	115
Cascading chargers.....	116
Charging the rechargeable battery.....	118
Power saving mode.....	120
Updating the firmware of the charger.....	121
L 70 USB charger.....	124
Connecting/disconnecting the charger to/from the power supply system.....	124
Charging the rechargeable battery.....	125
Modular L 6000 charger.....	127
Product overview.....	127



Connecting/disconnecting the L 6000 to/from the power supply system.....	129
Connecting the L 6000 to a network.....	130
Installing a charging module in the L 6000 charger.....	132
Installing the L 6000 in a rack.....	134
Switching the L 6000 on and off.....	136
Charging the rechargeable batteries in the L 6000 charger.....	137
Meaning of the LEDs.....	139
Preparing rechargeable batteries for storage (storage mode).....	141
Resetting settings (factory reset).....	142
Updating the firmware.....	143
Operating the L 6000 via a network.....	144
Cleaning and maintenance.....	145
5. Knowledge base.....	146
Network guide.....	146
Introduction.....	146
General requirements.....	147
Network setups.....	150
Ports, protocols and services.....	154
Best practice.....	158
Security guide.....	161
Introduction.....	161
Key product security features.....	163
How to use the security features.....	167
Troubleshooting.....	174
License activation fails.....	174
No device access via the WebUI.....	176
The Base Station cannot be found.....	177
Interference noise with old RF devices.....	178
Noise in the audio signal.....	179
6. Specifications.....	180
Spectera System.....	180
Base Station.....	182
SEK.....	185
DAD.....	187
CHG 70N-C charger.....	189
BA 70 rechargeable battery.....	191
L 70 USB charger.....	192



Modular L 6000 charger.....	193
LM 6060 LM 6061 LM 6062 LM 6070 charging modules.....	195



1. Preface

PDF Export of the Original HTML Manual

This PDF document is an automatic export of an interactive set of HTML manuals. Some content and interactive elements may not be included in the PDF because they cannot be displayed in this format. In addition, automatically generated page breaks may cause related content to be slightly shifted. We can therefore only guarantee the completeness of the information in the HTML manual and recommend using it. You can find it in the Documentation Portal at www.sennheiser.com/documentation.



2. Quick start

All necessary information for activating the license and configuring the required ports of the device.

When starting up the Base Station for the first time, it is necessary to have a direct internet connection to activate the license. Additionally, certain ports must be enabled (especially for the organization/enterprise firewall) for communication between software and devices.

1. Connect the Base Station to a network:

- ▶ Plug one side of the network cable into the **Control** socket.

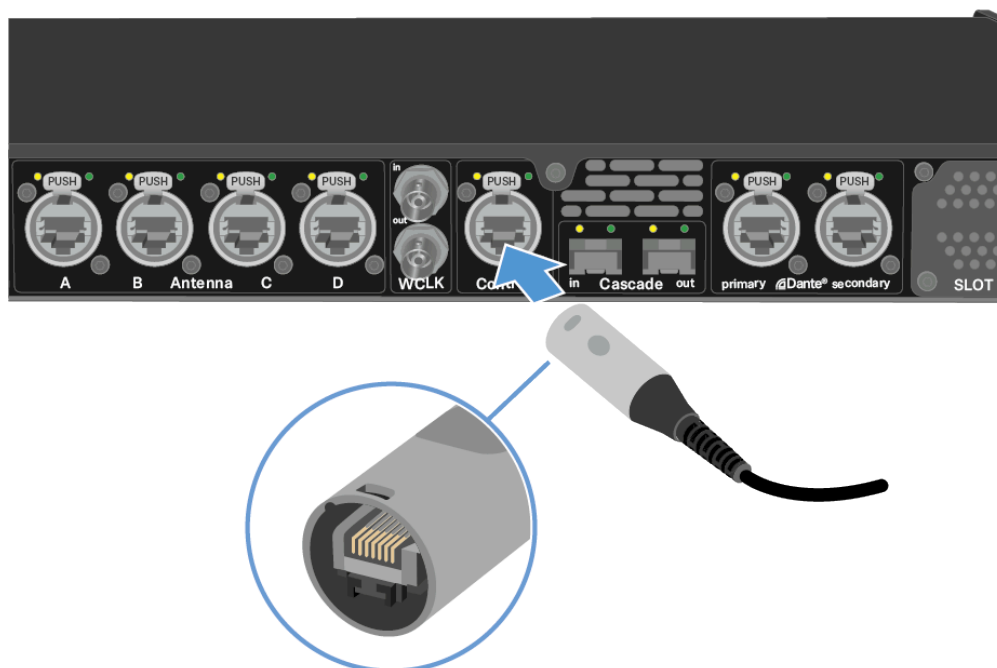

- ▶ Plug the other side of the network cable to a switch or router.
- ✔ The Base Station has been connected to a network.

2. Enable necessary ports for activation:

- ▶ Please contact your IT administrator to provide Internet access to the License Server and any NTP server by opening the required network ports and to provide DNS settings via DHCP to the device.

Address	Port	Protocol	Type	Service	Usage
my.nalpeiron.com	80	HTTPS (TCP)	Unicast	Sennheiser License Server	Activation of devices



ANY (see list of [NTP servers](#)) 123 NTP Unicast NTP Time Server Synchronize system time

i You can find the complete overview of all ports at [Ports, protocols and services](#).

3. Ensure that the network has an Internet connection and activate the license:

NOTICE



License activation requires a direct Internet connection to the device

In order to activate the Base Station using the 18-digit license code, a direct Internet connection is required.

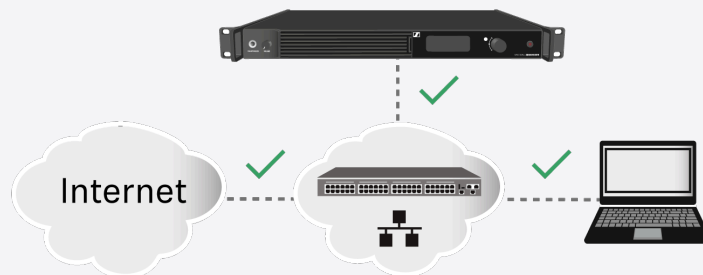

- ▶ Please connect your Base Station directly to a network with Internet access via a switch or router. For more information, refer to the chapter [Connecting to a network](#).
- ▶ Direct connections via laptop etc. are not supported for activation!

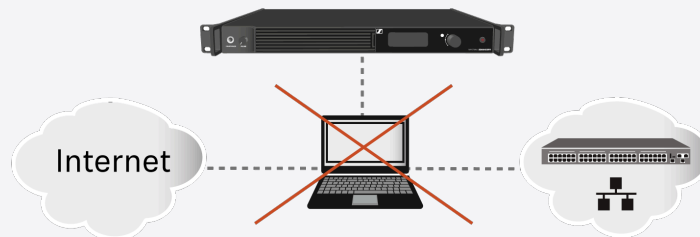

- ▶ The Internet is only required once for activation.

- ▶ If you want to activate a license via Spectera WebUI, follow the steps described here: [Activating a license \(WebUI\)](#).



3. Product information

All information about the product, the scope of delivery and the available accessories.

Spectera System

Sensing Capabilities - Audio detection and transmission

Spectera devices (Base Station, DAD, SEK) build audio transmission system for professional use. Once paired, SEK mobile devices can transmit audio signals captured by a connected microphone over radio frequencies. Due to its bi-directionality, the SEK is able to receive audio signals from DAD and the sound comes out of the headphones, if any connected. Here how it works:

Transmission:

1. The microphone connected to the SEK picks up the sound and converts it into electrical signals.
2. The SEK then prepares these signals for transmission by amplifying and modifying them.
3. The signals are sent over radio waves to the DAD Antenna.
4. The DAD antenna changes the radio back into electrical signals and sent them to the Base Station for further audio processing.

Receiving:

1. The Base Station forward audio signals to the DAD Antenna.
2. These signals are then prepared for transmission by boosting and modifying them.
3. The signals are sent over radio waves to the SEK mobile devices.
4. The SEK changes the radio back into electrical signals and at a further stage, sound will be directed to connected headphones.



Base Station



Base Station | 1350 - 1525 MHz | Art. no. 509162

The license for the Base Station is available in the following versions:

Name	Art. no.	Frequency range	Certified Countries*
SPECTERA LIC (ZONE 01)	700 532	UHF (470 - 608 MHz, 630 - 698 MHz) 1G4 (1350 - 1400 MHz, 1492 - 1525 MHz)	EU + EFTA, United Kingdom, Turkey
SPECTERA LIC (ZONE 02)	700 533	UHF (470 - 608 MHz, 657 - 663 MHz) 1G4 (1435 - 1525 MHz Certification pending)	USA
SPECTERA LIC (ZONE 03)	700 534	UHF (470 - 608 MHz, 657 - 663 MHz)	Canada
SPECTERA LIC (ZONE 04)	700 535	UHF (470 - 534 MHz, 534 - 608 MHz, 630 - 698 MHz)	Singapore
SPECTERA LIC (ZONE 05)	700 536	UHF (470 - 608 MHz, 630 - 698 MHz) 1G4 (1350 - 1400 MHz)	South Africa
SPECTERA LIC (ZONE 06)	700 537	UHF (470 - 608 MHz, 630 - 694 MHz)	Malaysia, Qatar
SPECTERA LIC (ZONE 07)	700 538	UHF (470 - 510 MHz, 630 - 698 MHz)	Israel
SPECTERA LIC (ZONE 08)	700 539	UHF (487 - 608 MHz, 630 - 694 MHz)	Indonesia
SPECTERA LIC (ZONE 09)	700 540	UHF (470 - 608 MHz, 630 - 694 MHz) 1G4 (1350 - 1400 MHz)	United Arab Emirates
SPECTERA LIC (ZONE 10)	700 541	UHF (470 - 608 MHz, 630 - 698 MHz)	Philippines
SPECTERA LIC (ZONE 11)	700 542	UHF (520 - 608 MHz, 630 - 694 MHz)	Australia
SPECTERA LIC (ZONE 12)	700 543	UHF (510 - 606 MHz)	New Zealand



Name	Art. no.	Frequency range	Certified Countries*
SPECTERA LIC (ZONE 13)	700 544	UHF (479 - 565 MHz)	Hong Kong
SPECTERA LIC (ZONE 14)	700 728	UHF (470 - 608 MHz)	Egypt, Mexico
SPECTERA LIC (ZONE 15)	701 015	UHF (510 - 530 MHz, 630 - 698 MHz, 6 MHz Bandwidth)	Taiwan
SPECTERA LIC (ZONE 16)	701 016	UHF (470 - 608 MHz, 6 MHz Bandwidth)	Brazil
SPECTERA LIC (ZONE 17)	701 016	UHF (470 - 510 MHz, 630 - 698 MHz)	China

* It is the responsibility of the user to inform themselves about the current local regulatory and certification requirements and to comply with them using wireless systems.

i You can find more detailed information about the Base Station in the following sections:

- **Startup and operation:** [Base Station](#)
- **Specifications:** [Base Station](#)



SEK



The SEK is available in the following versions:

SEK UHF | 470 - 698 MHz | Art. no. 509164

SEK 1G4 | 1350 - 1525 MHz | Art. no. 509163

i You can find more detailed information about the SEK in the following sections:

- **Startup and operation:** [SEK](#)
- **Specifications:** [SEK](#)



DAD



DAD (UHF)



DAD (1G4)

The Digital Antenna Directional (DAD) is available in the following versions:

DAD UHF | 470 - 698 MHz | Art. no. 509169

DAD 1G4 | 1350 - 1525 MHz | Art. no. 509170

i You can find more detailed information about the DAD in the following sections:

- **Startup and operation:** [DAD](#)
- **Specifications:** [DAD](#)



Accessories

Accessories for the Base Station

MADI Cards

MADI Card (BNC) for Base Station | Art. no. 509293



MADI Card (OM) for Base Station | Art. no. 509295

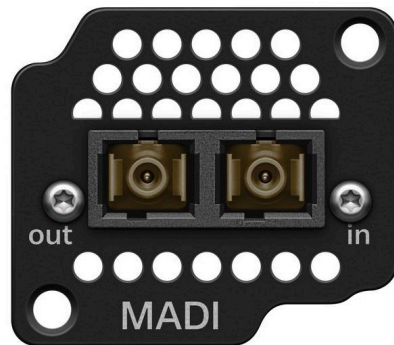

- See [Installing slot-in cards](#)

Spectera Filter set

Three exchangeable **filters** for the Base Station | Art. no. 700073



- See [Changing the fan filter](#)



Accessories for the SEK

Spectera SEK Antenna

SEK Antenna (UHF) | 470 - 698 MHz | Art. no. 700066



SEK Antenna (1G4) | 1350 - 1525 MHz | Art. no. 700067



- See [Mounting the antenna](#)

Spectera SEK Belt Clip

SEK Belt Clip | Art. no. 700071

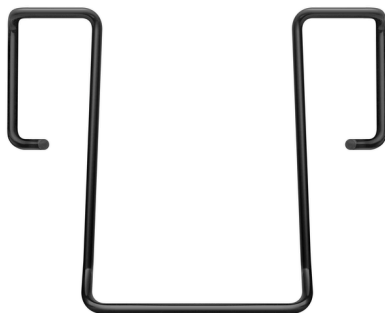

- See [Changing the belt clip](#)

3-pin protective cap MIC/LINE

Exchangeable protective **cap** for the microphone / instrument 3-pin connector | Art. no. 700072



- See [Using the protection cap](#)

COM Button

Command adapter for SEK | Art. no. 701014



- See Connecting the COM Button
- See Operating the SEK with the COM Button



Accessories for the DAD

Optional cables for DAD



Antenna cable cat 5e | 10 m | Art. no. 700068

Antenna cable cat 5e | 25 m | Art. no. 700069

Antenna cable cat 5e | 50 m | Art. no. 700070

- See [Connecting/disconnecting the antenna](#)



CHG 70N-C network-enabled charger



CHG 70N-C | Charger | Art. no. 700332



CHG 70N-C + PSU KIT | CHG 70N-C charger with NT 12-35 CS power supply unit | Art. no. 700333

i You can find more detailed information about the CHG 70N-C in the following sections:

- **Startup and operation:** [CHG 70N-C charger](#)
- **Specifications:** [CHG 70N-C charger](#) | [BA 70 rechargeable battery](#)



BA 70 rechargeable battery and L 70 USB charger



BA 70 | Rechargeable battery | Art. no. 508860

L 70 USB | Charger | Art. no. 508861

EW-D CHARGING SET | L 70 USB charger with two BA 70 rechargeable batteries | Art. no. 508862

i You can find more detailed information about the BA 70 rechargeable battery and the L 70 USB charger in the following sections:

- **Startup and operation:** [L 70 USB charger](#)
- **Specifications:** [L 70 USB charger](#) | [BA 70 rechargeable battery](#)



Modular L 6000 charger

The L 6000 charger is used to charge the BA 60, BA 61, BA 62 and BA 70 rechargeable batteries.

The charging modules LM 6060 (for the BA 60), LM 6061 (for the BA 61), LM 6062 (for the BA 62) or LM 6070 (for the BA 70) are required to do so. The rechargeable batteries and charging modules are available separately.



- **L 6000 EU** | Article no. 507300

i You can find more detailed information about the L 6000 charger and the LM 6060, LM 6061, LM 6062 and LM 6070 charging modules in the following sections:

- **Installation and Operation:** [Modular L 6000 charger](#)
- **Specifications:** [Modular L 6000 charger](#) and [LM 6060 | LM 6061 | LM 6062 | LM 6070 charging modules](#)

Delivery includes

- 1 L 6000 charger
- 1 mains cables (EU, UK, or US variant)
- 4 dummy caps including screws (preassembled)
- 4 rubber feet
- 1 quick guide
- 1 manual with safety instructions
- 1 manual with technical data and manufacturer declarations

Product overview

View with the charging modules and rechargeable batteries inserted:



View with the LM 6060 charging modules without rechargeable batteries inserted:



View with the LM 6061 charging modules without rechargeable batteries inserted:





Charging modules for L 6000 charger

The following **charging modules** are available for the **L 6000** charger:

LM 6060

The LM 6060 charging module is installed in the L 6000 charger to charge the BA 60 rechargeable battery.

LM 6060 | Article no. 507198



LM 6061

The LM 6061 charging module is installed in the L 6000 charger to charge the BA 61 rechargeable battery.

LM 6061 | Article no. 507199



LM 6062

The LM 6062 charging module is installed in the L 6000 charger to charge the BA 62 rechargeable battery.

LM 6062 | Article no. 508516





LM 6070

The LM 6070 charging module is installed in the L 6000 charger to charge the BA 70 rechargeable battery of the Evolution Wireless Digital series.

LM 6070 | Article no. 509457





4. Instruction manual

Detailed description of the start-up and operation of your selected hardware.

i Instruction manuals about controlling the Spectera System via LinkDesk and Spectera WebUI can be found here:

- Instruction manual [LinkDesk](#)
- Instruction manual [WebUI](#)

Important Information on License Activation

NOTICE



License activation requires a direct Internet connection to the device

In order to activate the Base Station using the 18-digit license code, a direct Internet connection is required.

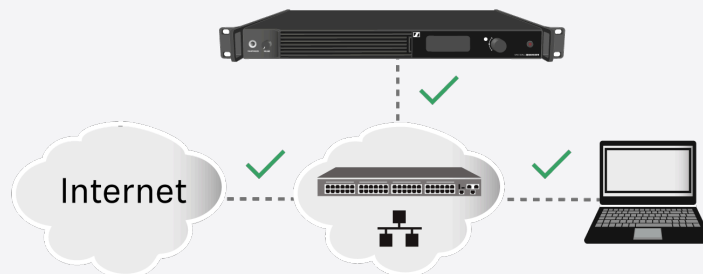

- ▶ Please connect your Base Station directly to a network with Internet access via a switch or router. For more information, refer to the chapter [Connecting to a network](#).
- ▶ Direct connections via laptop etc. are not supported for activation!

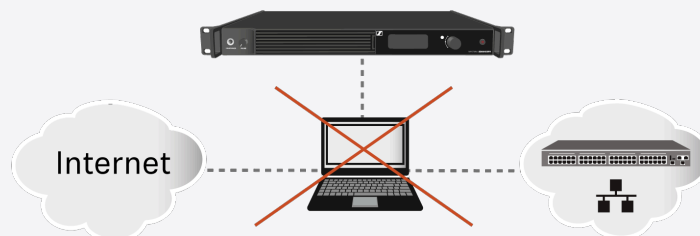

- ▶ The Internet is only required once for activation.



Base Station

Get started

Get your Base Station ready to use in a few steps.

After unpacking the Base Station you must update the firmware **before** activating a licence.

NOTICE



License activation requires a direct Internet connection to the device

In order to activate the Base Station using the 18-digit license code, a direct Internet connection is required.

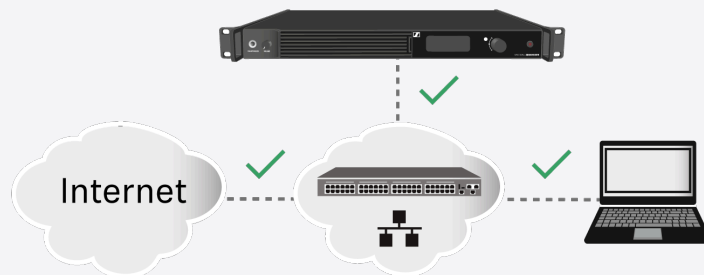

- ▶ Please connect your Base Station directly to a network with Internet access via a switch or router. For more information, refer to the chapter [Connecting to a network](#).
- ▶ Direct connections via laptop etc. are not supported for activation!

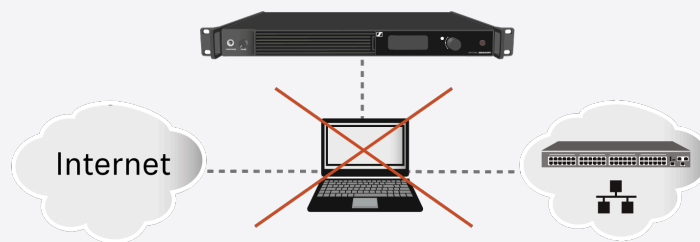

- ▶ The Internet is only required once for activation.



To connect the Base Station to the power supply system:

- ▶ Connect one mains cable to the power socket on the rear side of the Base Station.

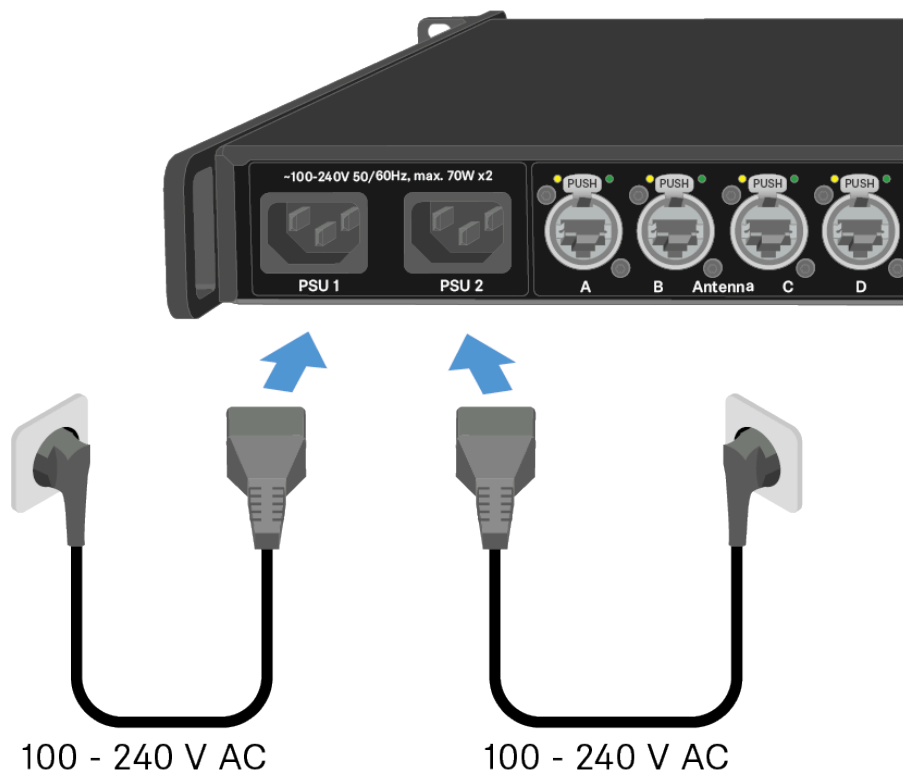

- ▶ Connect one mains cable plug into a suitable wall socket.
 - ✓ The Base Station is connected to the power supply.



To connect the Base Station to a network:

- ▶ Plug one side of the network cable into the **Control** socket.

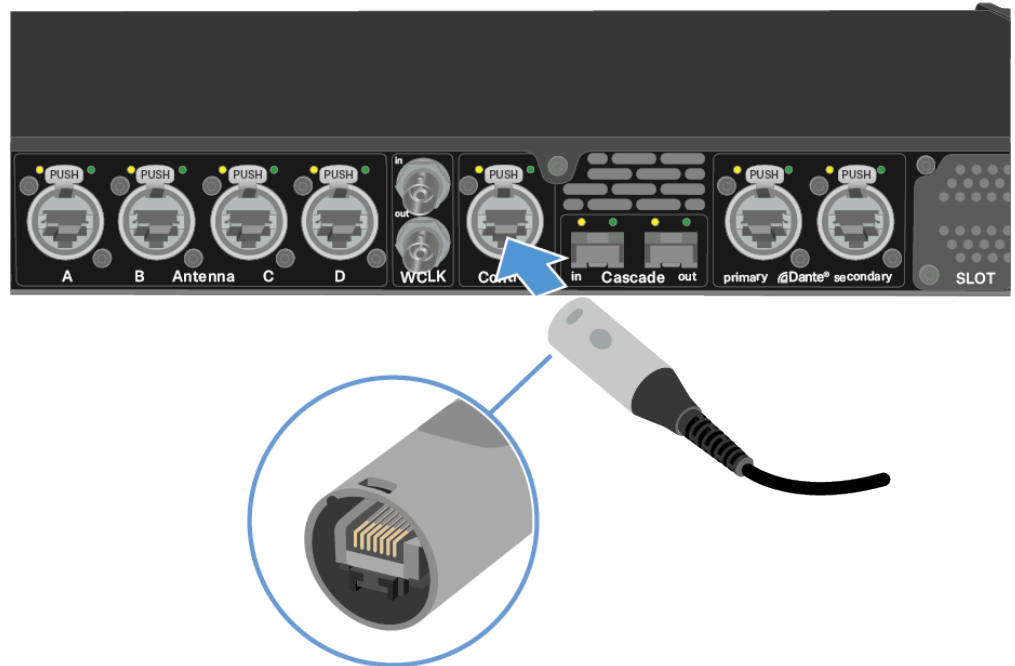

- ▶ Plug the other side of the network cable to a switch, router or directly to a computer.

i The Base Station needs a direct Internet access!

- ✓ The Base Station has been connected to a network.

To update the firmware:

- ▶ To start the Spectera WebUI, enter the following URL into your browser: `https://deviceIP`.

i The device IP can be found here: [Network](#).

- ✓ In some cases the internet browser might have trouble showing the page.

✓ Your Base Station is up to date.

You can now add a licence, see [Activating a license \(general\)](#).



General information for the System

Here you can find general information for your use of the System.

i A license has to be activated, otherwise you cannot use the Base Station.

The Base Station has two independent RF channels. Both variants of the antenna (UHF and 1G4) can be connected to the Base Station at the same time.

You can pair up to 128 mobile devices to a Base Station within one RF channel.

i Mobile devices can only be paired and operated with one Base Station at a time.



Product overview

Front



1 HEADPHONES socket

see [Using the headphone output](#)

2 VOLUME control for headphone

see [Using the headphone output](#)

3 Fan inlet with filter

see [Changing the fan filter](#)

4 Display for status information and operating menu

see [Information on the display](#)

5 LED to indicate the status

see [Meaning of the LED](#)

6 Jog-Dial (UP/DOWN/SET) for navigating the menu

see [Navigating the menu](#)

7 ON/OFF button

see [Switching the Base Station on and into standby](#)

Back

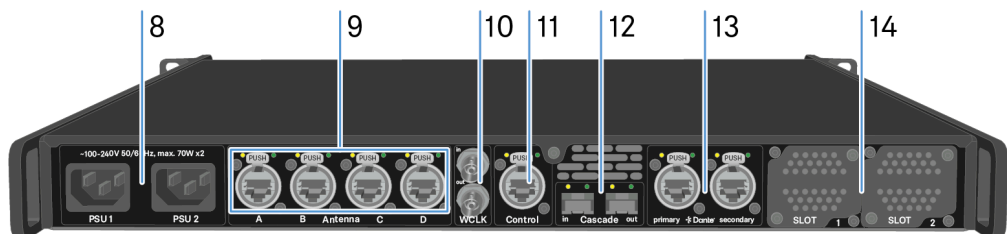

8 Power socket

see [Connecting/disconnecting the Base Station to/from the power supply system](#)

9 4x ruggedized RJ45 Antenna ports

see [Connecting antennas](#)

10 Word clock in/out

see [Connecting word clock](#)



11 ruggedized RJ45 **Control** port

see [Connecting to a network](#)

12 Cascade in/out

see [Cascading the Base Stations](#)

13 2x ruggedized RJ45 ports for **Dante**[®] primary | secondary

see [Connecting audio via Dante](#)[®]

14 Slot 1 | 2 for MADI Cards

see [Installing slot-in cards](#)



Installing slot-in cards

The same or different cards can be installed.

Two types of MADI Cards are available, see [MADI Cards](#).

Madi CARD (BNC)

Madi CARD (OM)

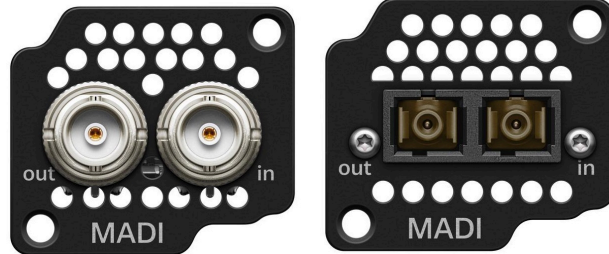

CAUTION



Improper handling of the device may result in its damage

Device contains sensitive electronics to electrostatic discharge (ESD).

- ▶ Observe the precautionary measures for handling components at risk of electrostatic discharge and take appropriate protective measures when touching the device.

To install a MADI Card in the Base Station:

- ▶ Completely disconnect the Base Station from the power supply system. See [Connecting/disconnecting the Base Station to/from the power supply system](#).
- ▶ Unscrew one of the dummy caps on the Base Station. To do so, you require a torx® 10 screwdriver.

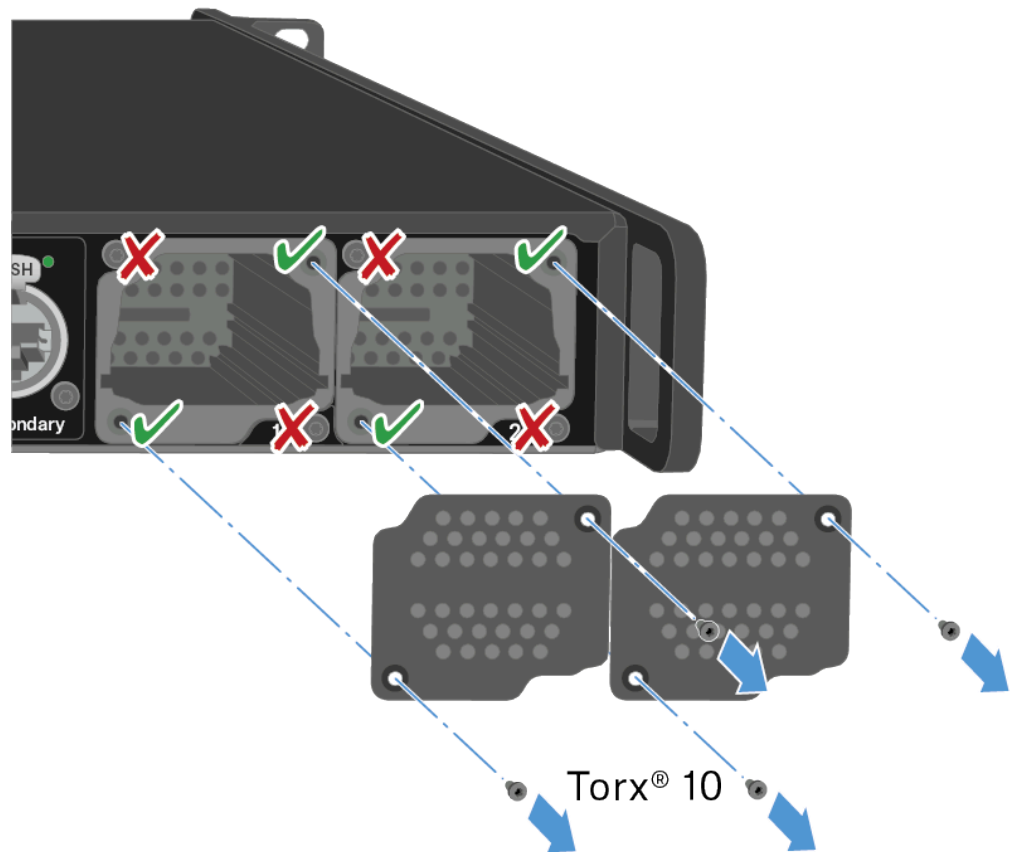

- ▶ Fully slide the MADI Card into the open slot as shown in the figure.
 - ✔ The card can be inserted into the Base Station housing only in one direction. The lettering on the card must face upward.
- ▶ Tightly screw on the MADI card with max. 65 cNm +/-10%.

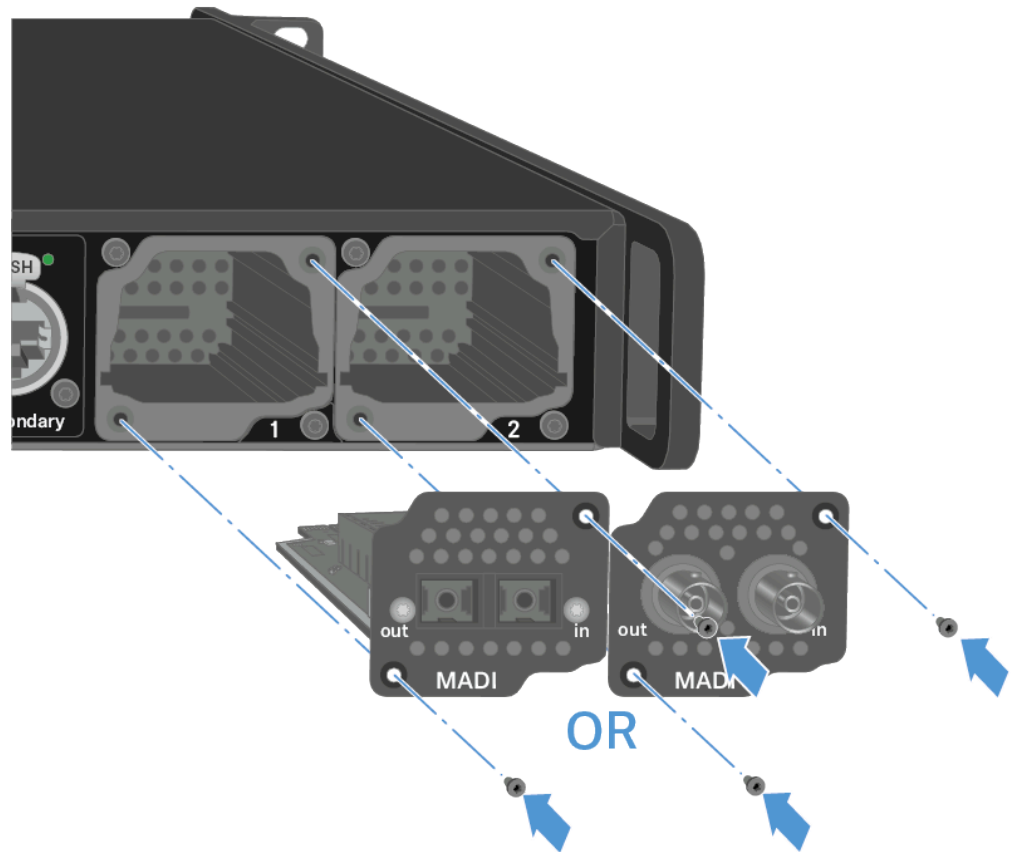

✓ The MADI Cards can be used directly.

✓ A MADI Card has been installed.



Connecting/disconnecting the Base Station to/from the power supply system

Optional for redundancy you can connect the Base Station with two cables. The optional cable is not included.

To connect the Base Station to the power supply system:

- ▶ Connect one mains cable to the power socket on the rear side of the Base Station.

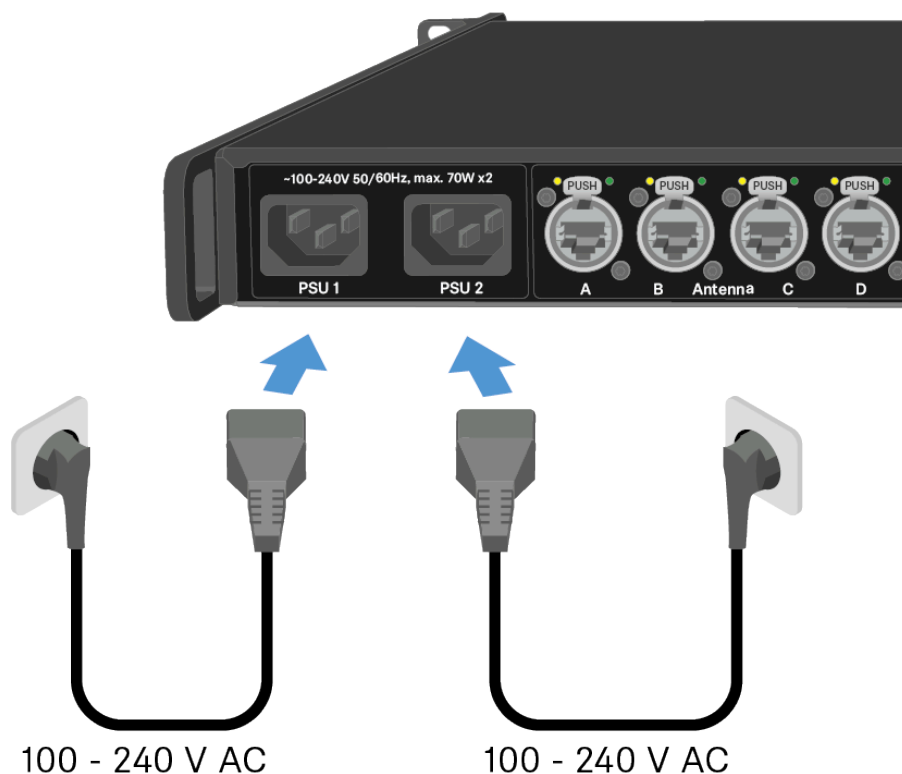

- ▶ Connect one mains cable plug into a suitable wall socket.
 - ✓ The last state is restored: on or standby.
- ▶ For redundancy connect an other cable (not included) as well.
 - ✓ The Base Station is connected to the power supply.

To completely disconnect the Base Station from the power supply system:

- ▶ Unplug both mains cable plugs from the wall socket.
- ▶ Unplug both mains cable from the power socket on the rear side of the Base Station.
 - ✓ The Base Station is completely disconnected from the power supply.



✓ The Base Station has been connected/disconnected successfully.



Connecting to a network

Connect the Base Station to a network for monitoring and controlling.

To connect the Base Station to a network:

- ▶ Plug one side of the network cable into the **Control** socket.

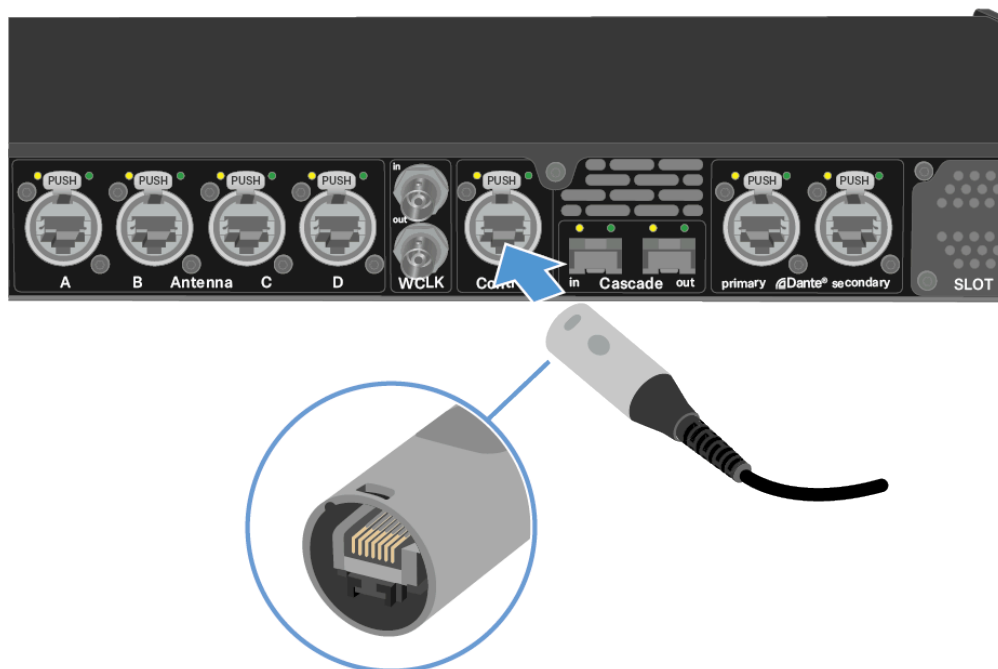

- ▶ Plug the other side of the network cable to a switch, router or directly to a computer.



NOTICE



License activation requires a direct Internet connection to the device

In order to activate the Base Station using the 18-digit license code, a direct Internet connection is required.

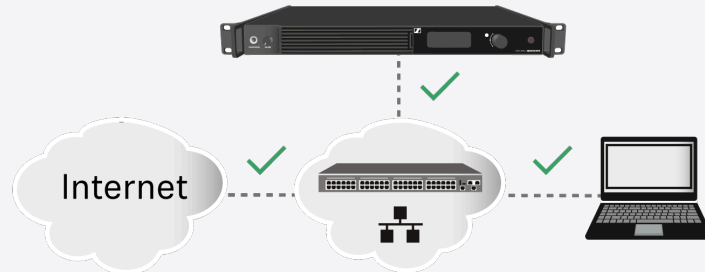

- ▶ Please connect your Base Station directly to a network with Internet access via a switch or router. For more information, refer to the chapter [Connecting to a network](#).
- ▶ Direct connections via laptop etc. are not supported for activation!

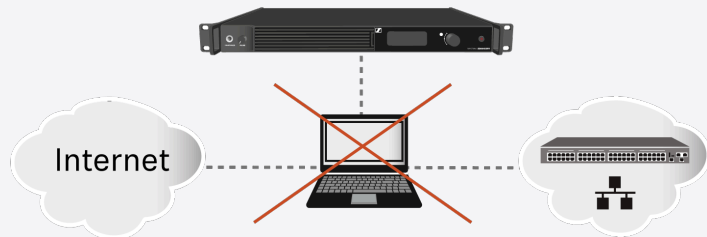

- ▶ The Internet is only required once for activation.

See [Activating a license \(general\)](#).

✓ The Base Station has been connected to a network.

You can monitor and control the Base Station via a network connection using Spectera WebUI.

To start the Spectera WebUI, enter the following URL into your browser: `https://deviceIP`.

i The device IP can be found here: [Network](#).



Connecting antennas

You can connect up to four antennas to the Base Station.

Recommendations regarding the antenna setup:

- Keep a distance more than 10 m (393.7") between the antenna and another antenna.
- Keep a distance more than 0.5 m (19.69") between the antenna and a wall.

The cable must

- be a CAT5e or higher,
- have ruggedized plugs and
- not extend 100 m (3937").

i We recommend using a antenna cable cat 5e (see [Accessories for the DAD](#)).

i Both variants (UHF and 1G4) can be connected to the Base Station at the same time.

To connect an antenna to the Base Station:

- ▶ Plug one side of the cable into one antenna port (A, B, C or D) at the rear side of the Base Station.
- ▶ Plug the other side of the cable into an antenna.

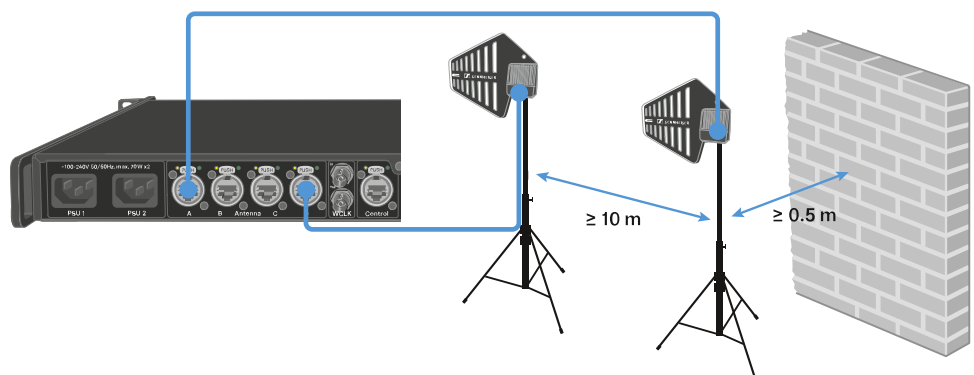

We recommend a distance greater than 10 m (393.7") for an optimal RF performance.

To disconnect an antenna from the Base Station:

- ▶ Hold down the push button.
- ▶ Unplug the cable from the Base Station.



✓ The Base Station has been connected to/disconnected from an antenna.

Antenna cable extension

Longer cable distances are possible with the use of fiber optic cables and media converters.

Sennheiser tested the recommend converters for a complete distance of 4 km (157480.31").

We only recommend the following converters for fully tested functionality:

i It is mandatory to use the media converters in pairs.

- Lantronix M/GE-PSW-PSE-01 (with PoE for DAD) **or**
- Lantronix M/GE-T-SFP-01 (needs a Class 2 PoE injector capable of supplying powering to the DAD (power consumption < 6.5 W)) **or**
- Barnfind Technologies BarnColor 4xEth (with PoE for DAD) **or**

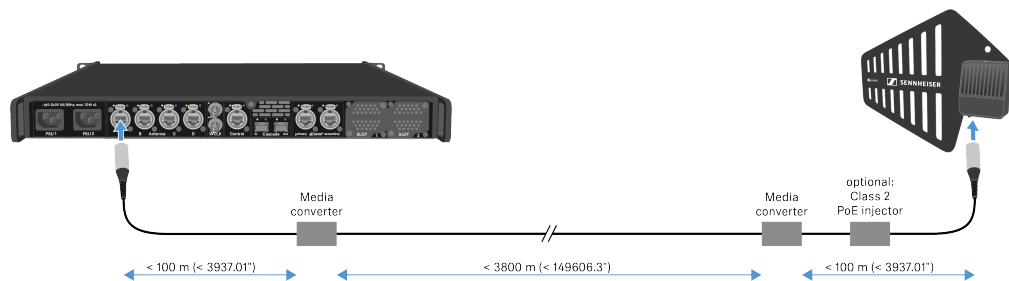

i The media converter must not have a switch function.



Connecting word clock

You can use the internal word clock on the Base Station or connect an external word clock.

You can also output the external word clock and cascade it up to 8 Base Stations.

The word clock output transmits only the external word clock that is connected via the word clock input. The internal word clock is not output via the word clock output.

i For more information about the word clock, see [Word clock scenarios for digital audio](#).

To connect an external word clock:

- ▶ Use a coaxial BNC cable (75 Ω) to connect the external word clock to the **word clock in** input.

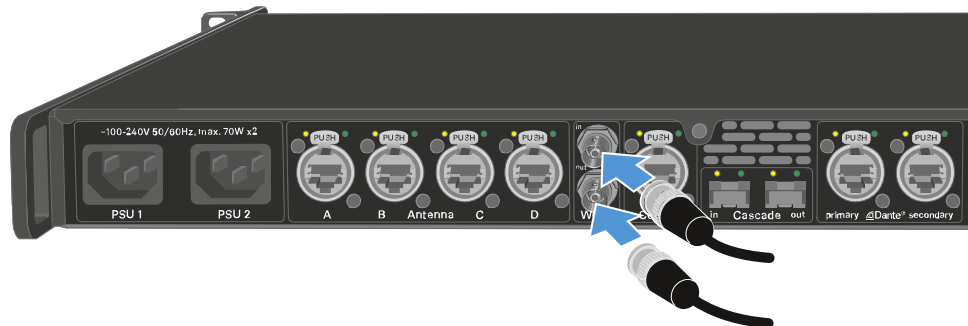



To cascade the word clock:

- ▶ Connect the cable from the **word clock in** input of the next Base Station to the **word clock out** output of the previous Base Station.

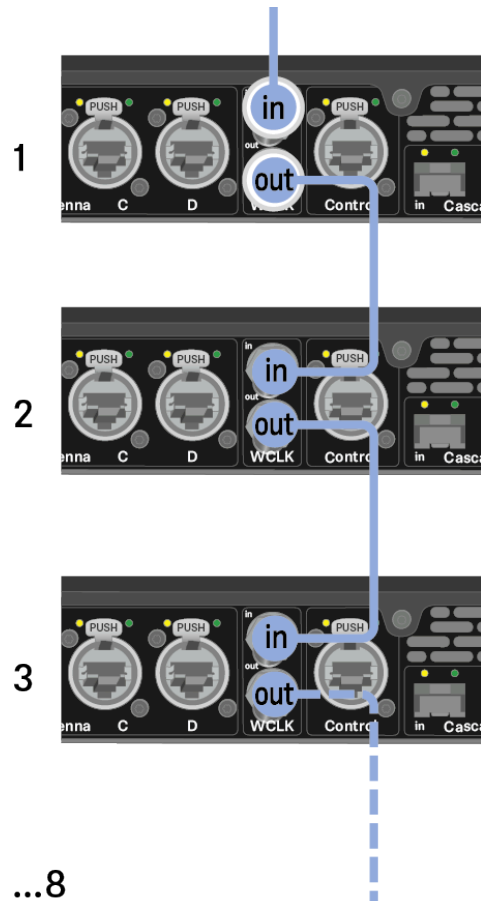

✓ The Base Station has been connected to word clock.

Word clock scenarios for digital audio

The Base Station supports two clock rates: 48 kHz and 96 kHz.

You can use either the internal word clock on the Base Station or connect an external word clock.

An external word clock can also be forwarded to a downstream device via the word clock output. This feature allows you to cascade up to 8 Base Station devices.

i Note that only the word clock on the word clock input can be forwarded via the word clock output. The internal word clock is not forwarded via the word clock output.



Word clock with digital audio

If multiple devices with digital audio signals are connected in a production environment, their clock signals must be synchronized via a word clock, otherwise audio errors occur. The word clock of one device becomes the master. All of the other devices become slaves and synchronize with the master.

Dante®

The Audinate Brooklyn III Dante® interface installed in the Base Station should be understood as a standalone digital audio device with its own word clock and also has to be clocked either internally or externally.

i You require the Dante Controller software from Audinate for these settings. You can access it using the link: [Dante Controller](#).

Defining the master and slave

The Base Station word clock input, the Base Station internal word clock, the word clock of the Audinate Brooklyn III Dante® interface, or the Dante® network can be defined as the master.

For WebUI see: [Audio interfaces](#).



Connecting audio via Dante®

You can input and output audio via Dante®.

To connect audio via Dante®:

- ▶ Plug one side of a ruggedized RJ45 cable to the Dante® primary socket.

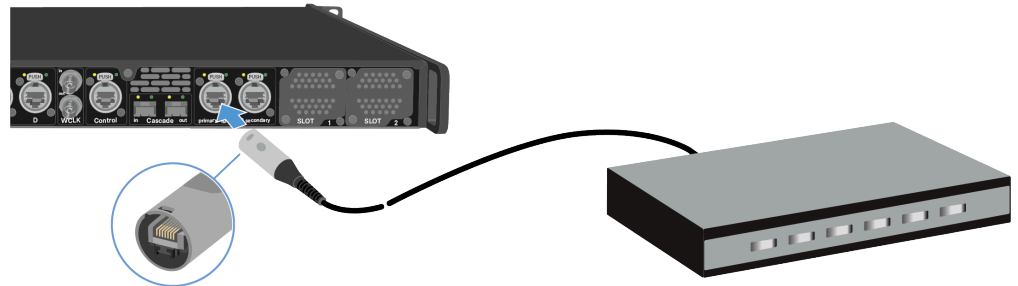

- ▶ Plug the other side into a router.
- ▶ Download the Dante® Controller.
This is typically a host computer (PC or Mac), with the Dante® Controller software application installed. This application configures and controls all the Dante® devices and audio streams inside the network.

i Information about the Dante Controller and the Dante® network protocol settings is available on the Audinate website: audinate.com.

✓ The Base Station can input and output audio via Dante®.

Shared network mode

In Shared Network Mode both networks for Control and Dante® are using the same physical network infrastructure.

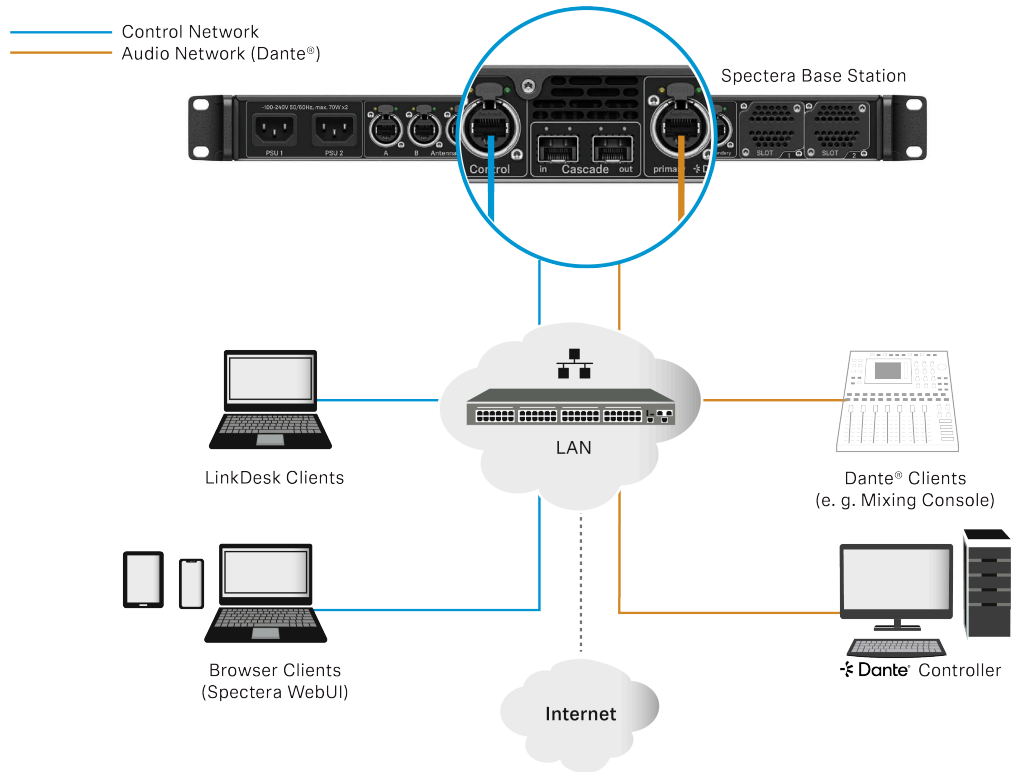

Split Network Mode

In Split Network Mode both networks for Control and Dante® are using different physical network infrastructure.

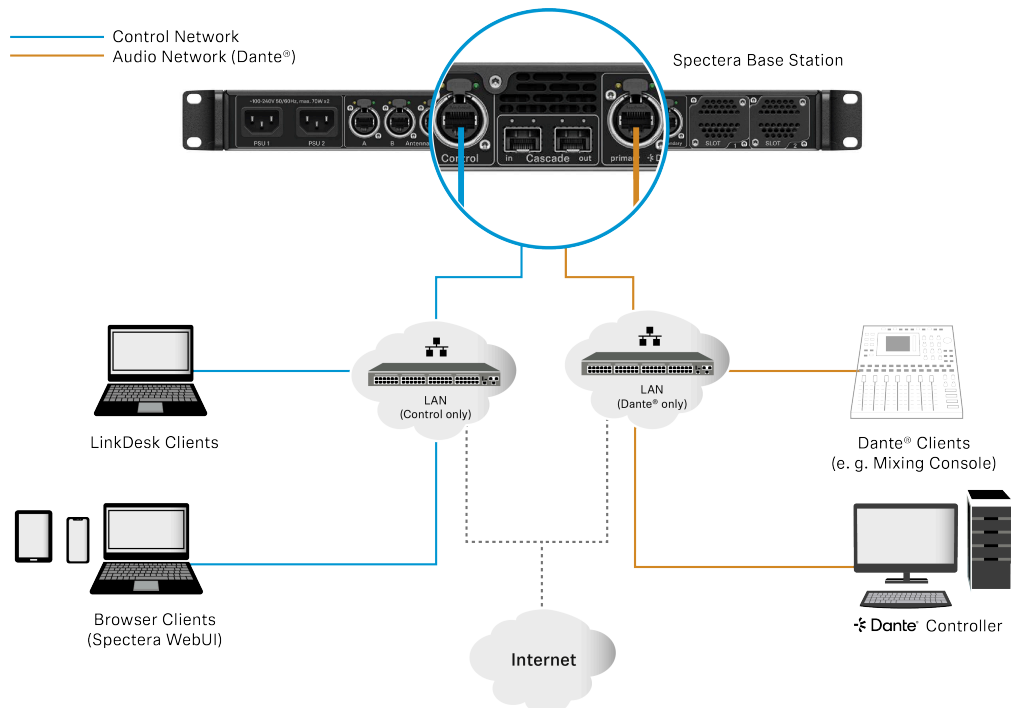



i For more information, please refer to the [Network guide](#).



Connecting audio via MADI

To connect audio via MADI:

- ▶ Plug one side of the (BNC or OM) cable to the installed MADI card.

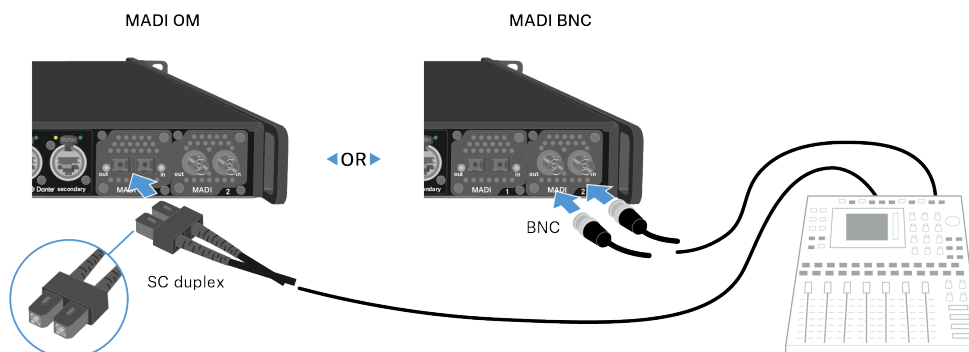

- ▶ Plug the other side of the cable to a mixing console.

✓ The Base Station can input and output audio via MADI.



Changing the fan filter

The filter protects the fans from dust.

- i** Check the filter from time to time and replace it to ensure safe operation and sufficient cooling.

To change the filter:

- ▶ Switch the Base Station into standby. See [Switching the Base Station on and into standby](#).
- ▶ Push down the release and pull the cover forward at the same time.

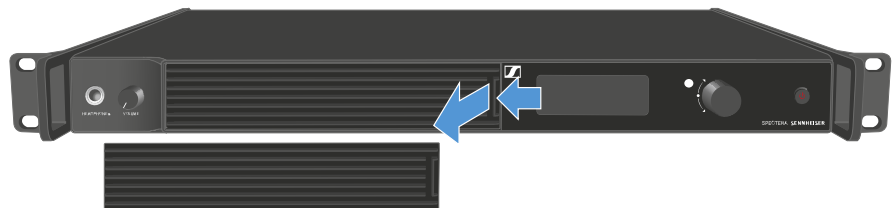

- ▶ Remove the filter and dispose it properly.
- ▶ Place a new filter in the Base Station.
Information about new filter can be found here: [Spectera Filter set](#).
- ▶ Make sure that the recesses match those in the device.

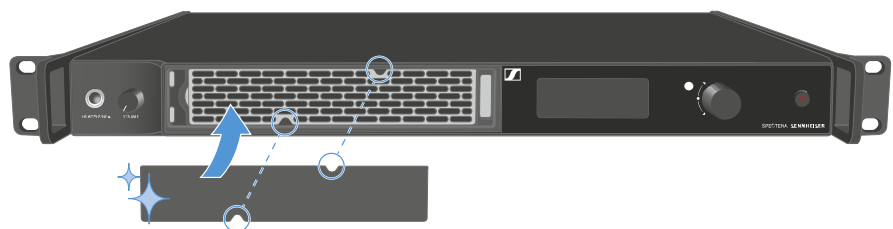

- ▶ Slide the cover into the left side.





- ▶ On the right side, press the cover firmly until you hear it click into place.



✓ The filter has been replaced.



Installing the Base Station in a rack

You can install the Base Station in any conventional 19" rack. The rack mounting angles are already attached to the device.

Always observe the following information during rack mounting.

NOTICE



Material damages caused by devices overheating

When there is insufficient ventilation, the devices mounted in the rack may overheat.

- ▶ Ensure that there is sufficient ventilation in the rack, particularly if several devices are installed.
- ▶ If necessary, install a fan in the rack.

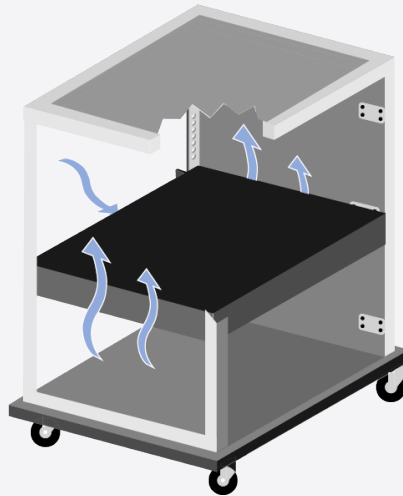

- ▶ Support the Base Station after installation in the rack.

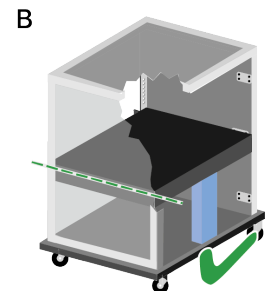
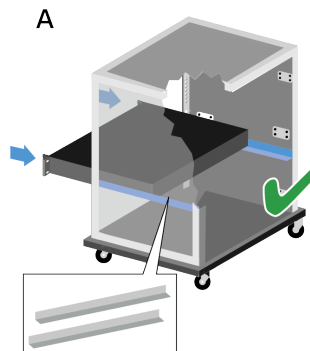
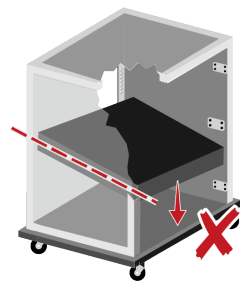

Due to the weight and depth of the device, there is a risk that it may break off in the rack and become damaged as a result.



Version A

- ▶ Use special rack mounting rails.
- ▶ The design of the rack used must be suitable for the installation of these mounting rails.

Version B

- ▶ Use a suitable object to support the device on the rear side.
- ▶ Ensure that this object cannot become loose.

✓ The Base Station has been installed in a rack.



Switching the Base Station on and into standby

- i** The Base Station cannot be switched off. You have to disconnect it from the power supply, see [Connecting/disconnecting the Base Station to/from the power supply system](#).

To switch the Base Station on:

- ▶ Short-press the **ON/OFF** button.
 - ✓ The Sennheiser Logo appears in the display and the Base Station is booting. When booting is done, the power button LED lights up white.

To switch the Base Station into standby:

- ▶ Long-press the **ON/OFF** button.
 - ✓ The display and the LED go off. The **ON/OFF** button pulses white.
- The DAD goes off.

- ✓ The Base Station has been switched on/into standby.



Activating a license (general)

i A license has to be activated, otherwise you cannot use the Base Station.

NOTICE



License activation requires a direct Internet connection to the device

In order to activate the Base Station using the 18-digit license code, a direct Internet connection is required.

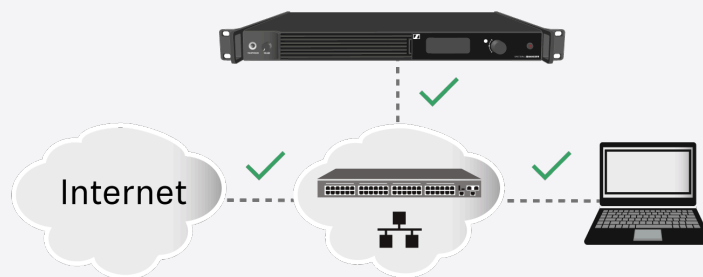

- ▶ Please connect your Base Station directly to a network with Internet access via a switch or router. For more information, refer to the chapter [Connecting to a network](#).
- ▶ Direct connections via laptop etc. are not supported for activation!

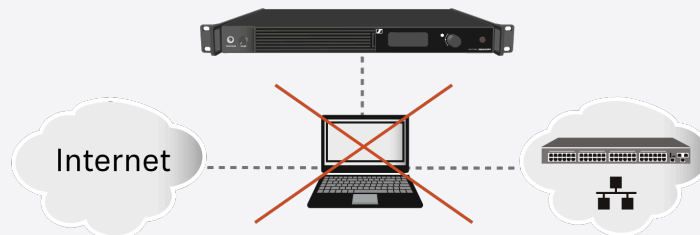

- ▶ The Internet is only required once for activation.

The license specifies the country-specific frequency ranges and the RF power.

You can activate a license via Spectera WebUI.

Only one license per Base Station is possible.

To activate a license:

- ▶ Connect the Base Station to the power supply, see [Connecting/disconnecting the Base Station to/from the power supply system](#).
- ▶ Connect the Base Station to a network via a switch or router, see [Connecting to a network](#).



i The Base Station needs a direct Internet access!

- ▶ Connect a computer to the same switch or router.
- ▶ If you want to activate a license via Spectera WebUI, follow the steps described here: [Activating a license \(WebUI\)](#).
- ▶ Check the product page sennheiser.com/base-station for the latest firmware.

✓ A license has been activated.



Using the headphone output

You can use the headphone output on the front of the Base Station (6.35 mm jack) to listen to the audio signals of the channels.

i First you have to set up audio links in Spectera WebUI.

WARNING



Danger due to high volume levels

Volume levels that are too high may damage your hearing.

- ▶ Turn down the volume of the headphone output before you put on the headphone.

To listen to an audio source:

- ▶ Connect the headphone to the **HEADPHONES** socket.

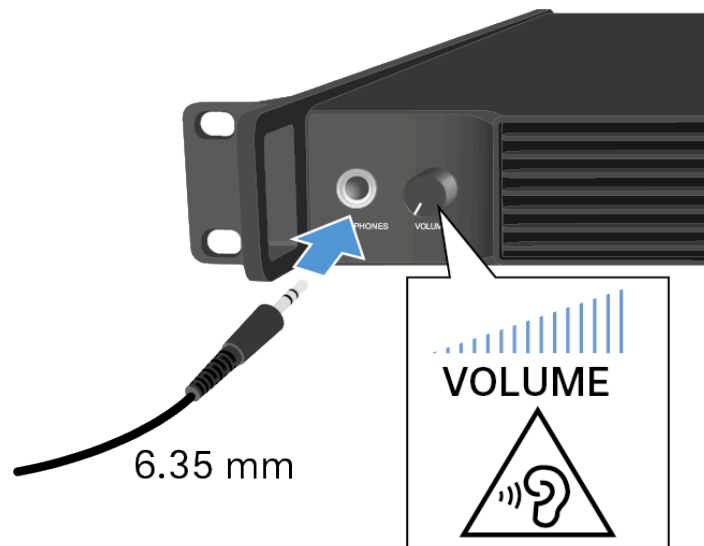

- ▶ You can select the audio source here: [Headphone](#).
- ▶ Control the volume by turning the **VOLUME** control next to the **HEADPHONES** socket.

✓ You can now listen to the selected audio source.



Meaning of the LED

The LED on the front of the Base Station indicates the following information.



The LED is off:

- Base Station is in standby.



The LED is green:

- Base Station is on and one or both RF channels are active.



The LED is yellow:

- One or both RF channels are muted.

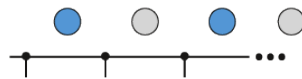

The LED is flashing blue:

- Paring is enabled.

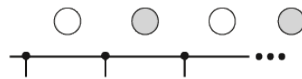

The LED is flashing white:

- The Base Station is identified.

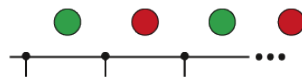

The LED is flashing green and red:

- Firmware update is in progress.



The LED is red:

- Base Station is working, but shows a warning on the display.

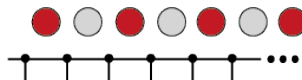

The LED is flashing red quickly:

- Error. Base Station is not working and shows a warning on the display.



Information on the display

Basic information are shown on the display.

The display goes into screen saver after some time.

You can wake up the display by pressing or turning the jog-dial.

The display shows the operating menu, which can be used to configure a few settings (see [Menu structure](#)).

i More options and other parameters are available in Spectera WebUI!

To navigate the menu, see [Navigating the menu](#).

Status messages

In certain situations, status messages may appear on the display.

**Critical Temperature -
Audio processing stopped
Please cool down Base Station!**

Error - The temperature is critical. The audio processing stopped. Cool down the Base Station.

**High Temperature -
Check ventilation to
avoid audio interruption**

Warning - The temperature is high. Check the ventilation to avoid audio interruption.

**Heating up Base Station
Please stand by**

Warning - The temperature is low. The Base Station is heating up. Please stand by.



Navigating the menu

Use the jog-dial to navigate through the operating menu.



Press the jog dial



- Calls up a menu item
- Changes to a submenu
- Saves settings

Turn the jog dial



- Changes to the previous or next menu item
- Changes the setting of a menu item



Menu structure

In the Base Station menu, you can configure a few settings.

i More options and other parameters are available in Spectera WebUI!

The following settings can be changed:

Mute/Unmute the RF-Channels

- [Main menu](#)

Change the IP mode

- [Network](#)

Select the audio source for the headphone

- [Headphone](#)

Reset the Base Station

- [Reset](#)

Main menu

In this menu item, you can view information about connections.

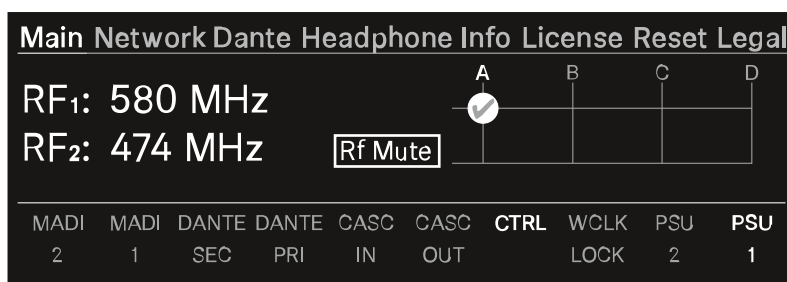

In the upper part you can view information about the RF channel:

- The selected frequency
- The state of the antenna (mute, active)
- Which antenna port is used for the RF channel.

In the lower part you can view information about the used connection:

- Connected ports are highlighted.
- The order corresponds to the ports on the back.



To mute/unmute the RF channel:

- ▶ Press the jog-dial.
- ✓ The RF Status menu opens.

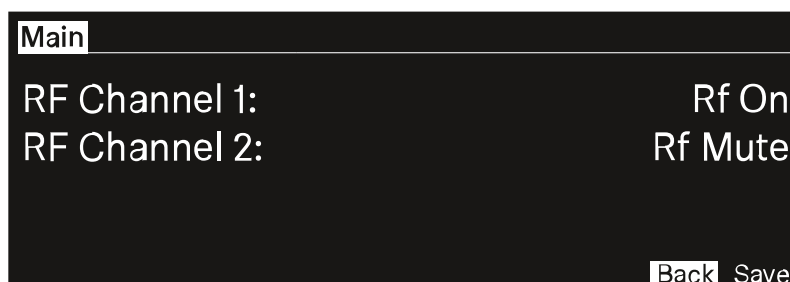

- ▶ Rotate and press the jog-dial to change the settings.
You can select between Rf on and Rf Mute.
- ▶ Confirm by selecting Save or discard the changes by selecting Back.

- ✓ The RF Channels have been muted/unmuted.



Network

In this menu item, you can configure the settings for the network connection.

Main Network Dante Headphone Info License Reset Legal	
IP Mode	AutoIp/mDNS
IP Addr	169.254.1.1
Netmask	255.255.0.0
Gateway	0.0.0.0

You can make the following settings here:

IP Mode

- Manual
 - You can change the IP Address, the Netmask and the Gateway.
- Manual/mDNS
 - You can change the IP Address, the Netmask and the Gateway.
- AutoIp
 - You can **not** change the IP Address, the Netmask and the Gateway.
- AutoIp/mDNS
 - You can **not** change the IP Address, the Netmask and the Gateway.



Dante

In this menu item, you can view information about the two Dante® connections.

<u>Main Network Dante Headphone Info License Reset Legal</u>	
Sampling rate	48 kHz
Primary	Autolp/mDNS
Secondary	Autolp/mDNS
Status	connected

The following information are displayed:

- Sampling rate
- IP mode for Primary
- IP mode for Secondary
- Status

To display a Dante® connection:

- ▶ Press the jog-dial to change the Dante® connection.
- ▶ Rotate the jog-dial to change between Primary and Secondary.

Dante	
Primary	Secondary
IP Addr	XX.XX.XX.XX
Netmask	XXX.XXX.XXX.XXX
Gateway	XX.XX.XX.X

- ▶ Press the jog-dial to enter the setting.

✓ The selected Dante® connection is displayed.



Headphone

In this menu item, you can select the headphone output.

You have to set up audio links via Spectera WebUI for the mobile devices.

If no audio link is set this note will appear:

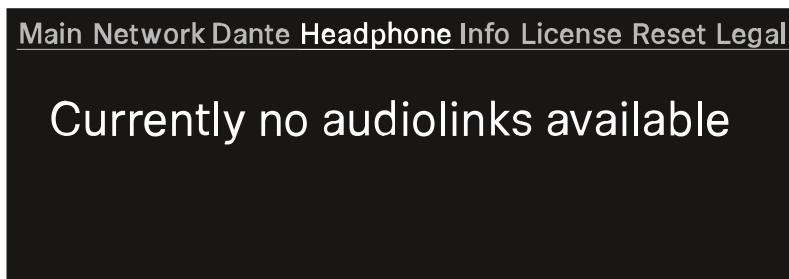

i First you have to set up audio links in Spectera WebUI.

To select an audio link:

- ▶ Press the jog-dial to enter the headphone menu.
Each audio output will be shown independent.
- ✔ The created audio links appear.

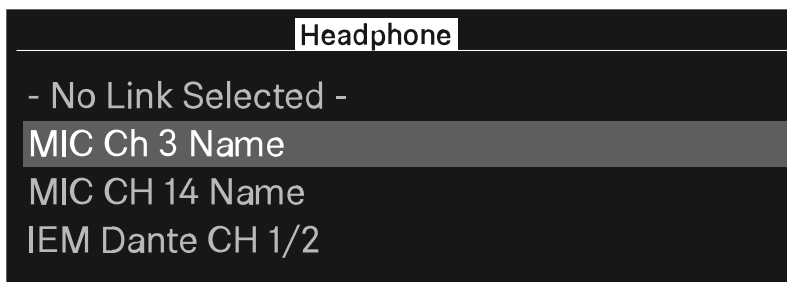

- ▶ Turn the jog-dial to select the wanted audio link.
- ✔ The name of the selected link pulses two times.

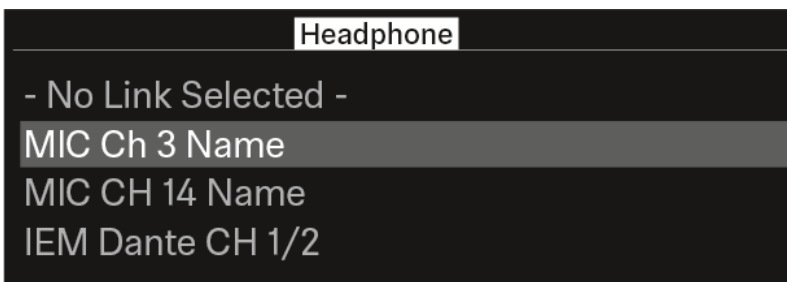

- ▶ Press the jog-dial to return to the main menu.



- ✓ The selected link appears.

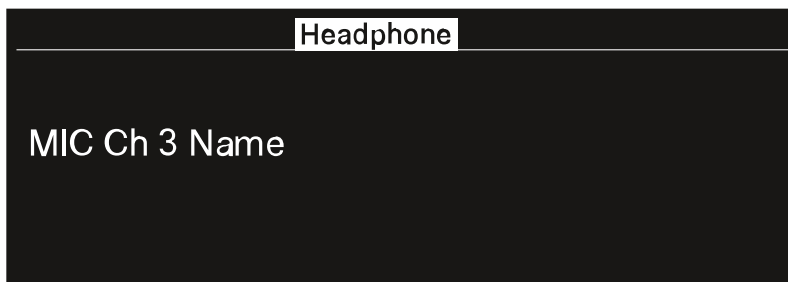

- ✓ You can now listen to the selected audio link.



Info

In this menu item, general information can be shown here.

Main Network Dante Headphone Info License Reset Legal	
Name	BaseStation Name
Serial	XXXXXXXXXX
Firmware	vX.X.X

Name: The name of the Base Station.

Serial: The serial number of the Base Station.

Firmware: The installed firmware version.



License

In this menu item, information about the license can be shown here.

i A license has to be activated, otherwise you cannot use the Base Station.

You can activate a license via Spectera WebUI.

Only one license per Base Station is possible.

The license specifies the country-specific frequency ranges and the RF power.

No license is activated:

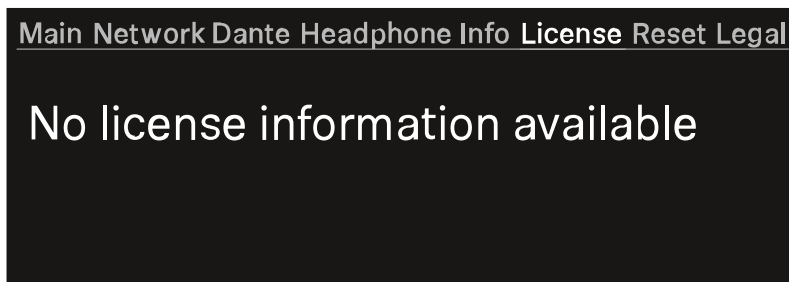

A license is activated

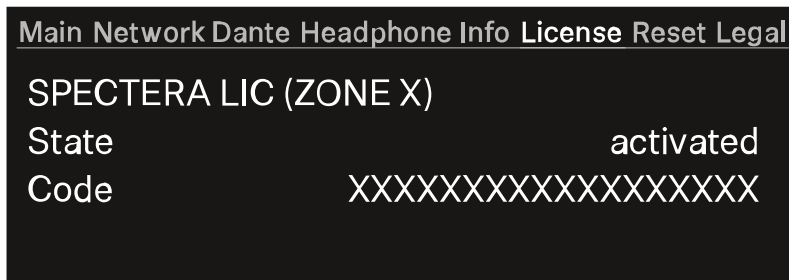

Name of the purchased license:

- Spectera LIC (ZONE 01)
- ...
- Spectera LIC (ZONE XX)

State: Status of the license.

- activated
- unknown

Code:

- The activated license number has 18 digits.
- n/a



Reset

In this menu item, you can reset the Base Station to its factory settings.

NOTICE



Data loss during the factory reset

All audio devices will be unpaired and all audio routes will be deleted.

All settings (including the device password) are reset to the default values. The license remains activated.

After the reset, the device is restarted automatically.

- ▶ Do not reset the Base Station during an active live audio transmission.

[Main](#) [Network](#) [Dante](#) [Headphone](#) [Info](#) [License](#) [Reset](#) [Legal](#)

Press to reset Base Station

To reset the Base Station to its factory default settings using the device:

- ▶ On the Base Station, rotate the jog-dial and navigate to the menu **Reset**.
- ▶ Press the jog-dial to enter the menu.
 - ✓ A warning will appear.

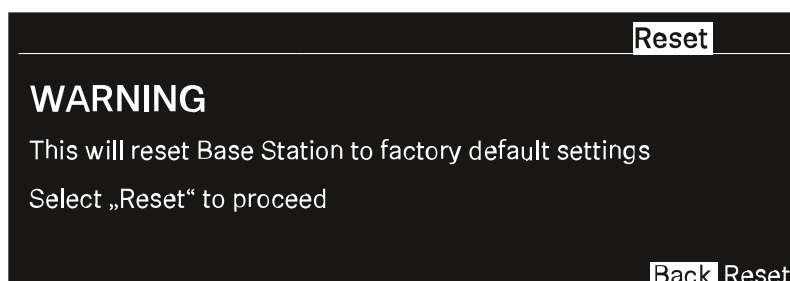

- ▶ Rotate the jog-dial to **Reset**.
- ▶ Press the jog-dial again.



- ✓ The Base Station will be set back to factory settings and reboot.

i After rebooting, check the IP address as it may have changed.

- ✓ The Base Station has been reset to its factory default settings.



Legal

In this menu item, legal information can be shown.

Legal information about the Base Station and connected antennas are displayed depending on the activated license.

If no label are available, the display shows:

Main Network Dante Headphone Info License Reset **Legal**

No legal information available



Updating the Base Station

You can update the firmware of the Base Station via Spectera WebUI.

All Spectera devices must use the same firmware. The Base Station determines the firmware version.

Please note that firmware versions are not backward compatible.

NOTICE



Data loss during firmware update

The audio transmission is interrupted during the firmware update of the Base Station, the antenna or the mobile device.

After the firmware update, the device is restarted automatically.

- ▶ Do not update the firmware during an active live audio transmission.

To update the firmware:

- ▶ If you want to update the Base Station via Spectera WebUI, follow the steps described here: [Updating the firmware \(Base Station\)](#).
- ✓ The LED is flashing green and red during the update.

When the update is installed, the Base Station restarts.

The update will be installed on the connected antennas automatically.

✓ The firmware has been updated.

The new firmware is distributed to the other devices via the Base Station.



SEK

Product overview

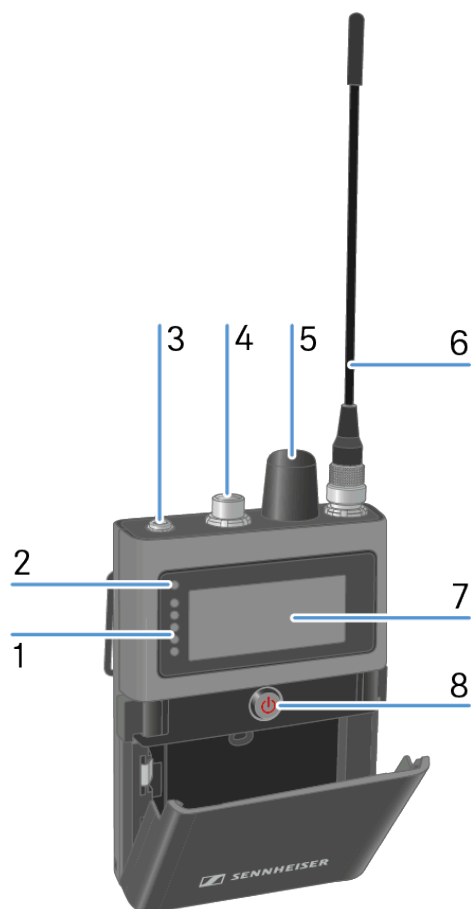

1 LEDs

see [Meaning of the LEDs](#)

2 Status LED

see [Meaning of the LEDs](#)

3 Phones 3.5 mm jack

see [To use the Phones jack](#)

4 Microphone / Instrument input

see [Connecting a microphone / instrument](#)

5 Rotary encoder

with push function

see [Information on the display](#)

6 Antenna

see [Mounting the antenna](#)



7 Display

see [Information on the display](#)

8 ON/OFF Button

see [Switching the SEK on and off](#)



Inserting and removing the rechargeable battery

The SEK operates only with the rechargeable battery BA 70 (separate accessory).

i The BA 70 can be charged in the L 70 USB, the L 6000 with LM 6070 or with the SEK in the CHG 70N-C. See

- L 70 USB: [Charging the rechargeable battery](#)
- L 6000: [Charging the rechargeable batteries in the L 6000 charger](#)
- CHG 70N-C: [Charging the rechargeable battery](#)

To insert the rechargeable battery into the SEK:

- ▶ Press the two catches and open the battery compartment cover.



- ▶ Insert the BA 70 rechargeable battery in the battery compartment.



- ▶ Close the battery compartment.



- ✓ The cover locks into place with an audible click.



✓ The battery has been inserted.



Mounting the antenna

Two antennas are available, one for each frequency range.

For more information see [Spectera SEK Antenna](#).

The antenna is screwed on when it is delivered.

To mount the antenna to the SEK:

- ▶ Connect the antenna to the SEK antenna socket.
- ▶ Tightly screw the antenna coupling ring onto the SEK antenna socket.

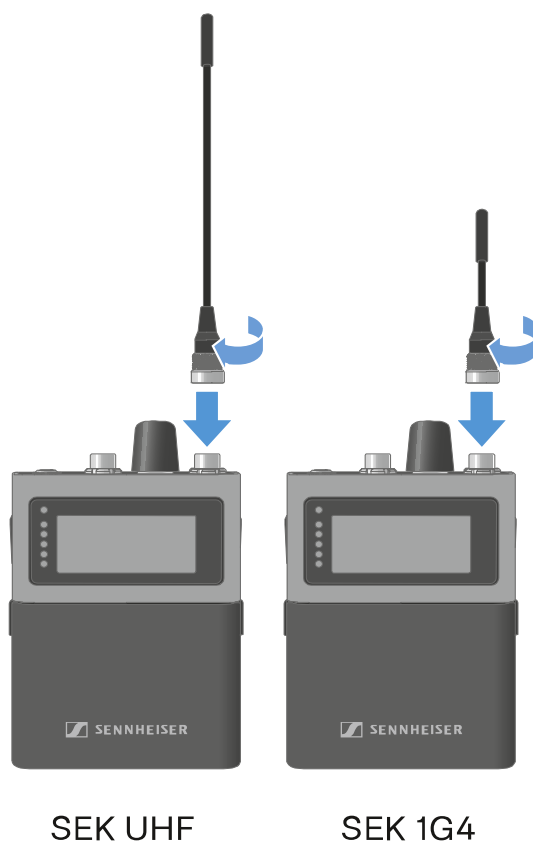

✓ The antenna has been mounted.



Using the protection cap

The cap protects the microphone / instrument input, when not in use.

To screw the cap on the SEK:

- ▶ Screw the cap on the microphone / instrument input socket.

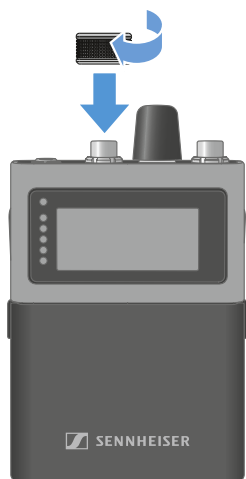

✓ The cap has been attached.



Connecting a microphone / instrument

You can connect a microphone or instrument to the SEK.

To connect a microphone to the SEK:

- ▶ Use a 3-pin audio connector to connect the microphone cable to the SEK microphone / instrument input socket.
- ▶ Screw the plug's coupling ring onto the microphone / instrument input thread of the SEK.

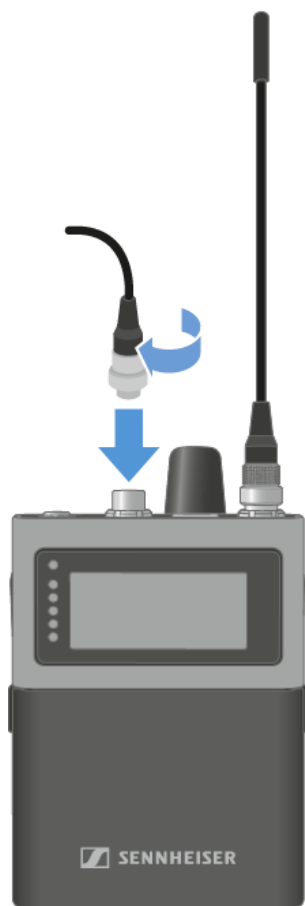



To connect a instrument to the SEK:

- ▶ Use a 3-pin audio connector to connect the instrument cable to the SEK microphone / instrument input socket.
- ▶ Screw the plug's coupling ring onto the microphone / instrument input thread of the SEK.



✓ A microphone or instrument has been connected.

i The automatic mic/line detection is based on power consumption and is optimized for use with Sennheiser microphones. Because third-party microphones vary widely, reliable detection cannot always be ensured. To select the auto input manually, see **Selecting the Mic/Line input**.

The following microphones are compatible:

- **Headmic 1 (3-Pin)** | Headset microphone with omni-directional pattern
- **Headmic 4 (3-Pin)** | Headset microphone with cardioid pattern
- **HM 200 (3-Pin)** | Headset microphone with omni-directional pattern
- **HSP 2 (3-Pin)** | Headset microphone with omni-directional pattern



- **HSP 4 (3-Pin)** | Headset microphone with cardioid pattern
- **ME 102 (3-Pin)** | Mini-microphone with omni-directional pattern
- **MKE 1 (3-Pin)** | Lavalier microphone with omni-directional pattern
- **MKE 2 (3-Pin) blue label** | Lavalier microphone with omni-directional pattern
- **MKE 40 (3-Pin)** | Lavalier microphone with cardioid pattern
- **MKE Essential (3-Pin)** | Lavalier microphone with omni-directional pattern



To use the Phones jack

i You have to set up an audio link in Spectera WebUI.

CAUTION



Danger due to high volume levels

Volume levels that are too high may damage your hearing.

- ▶ Turn down the volume of the headphone output before you put on the headphone.

The SEK checks the headphone's impedance when a headphone is plugged in at switching on, or each time a headphone is newly plugged in.

To connect earphones to the SEK:

- ▶ Turn down the volume.

i The volume can be altered between -100 dB to +27.5 dB in steps of 0.5 dB.

- ▶ Insert the cable's 3.5 mm jack plug into the phones socket on the SEK.

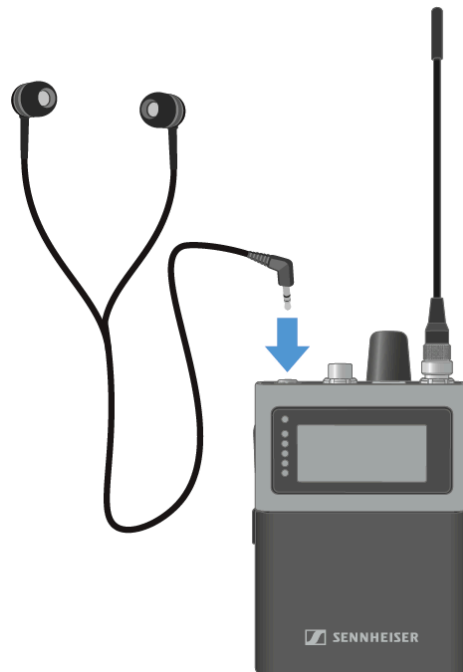



To connect an adapter cable:

- ▶ Insert the 3.5 mm jack plug of the cable into the **Phones** jack on the SEK.
- ▶ Connect the other plug to the desired device.
- ▶ In the WebUI, set the **Phones Output** to **Balanced**, see [Selecting the phones output](#). The **Balanced** setting can only be used with mono Link Modes.

✓ The **Phones** jack is used.



Changing the belt clip

You can change the belt clip on the SEK or flip it over depending on how you want to wear it.

To remove the belt clip:

- ▶ Hold down the belt clip with the thumb to the housing.
- ▶ Use the other hand to carefully pull back and then out one side of the belt clip.

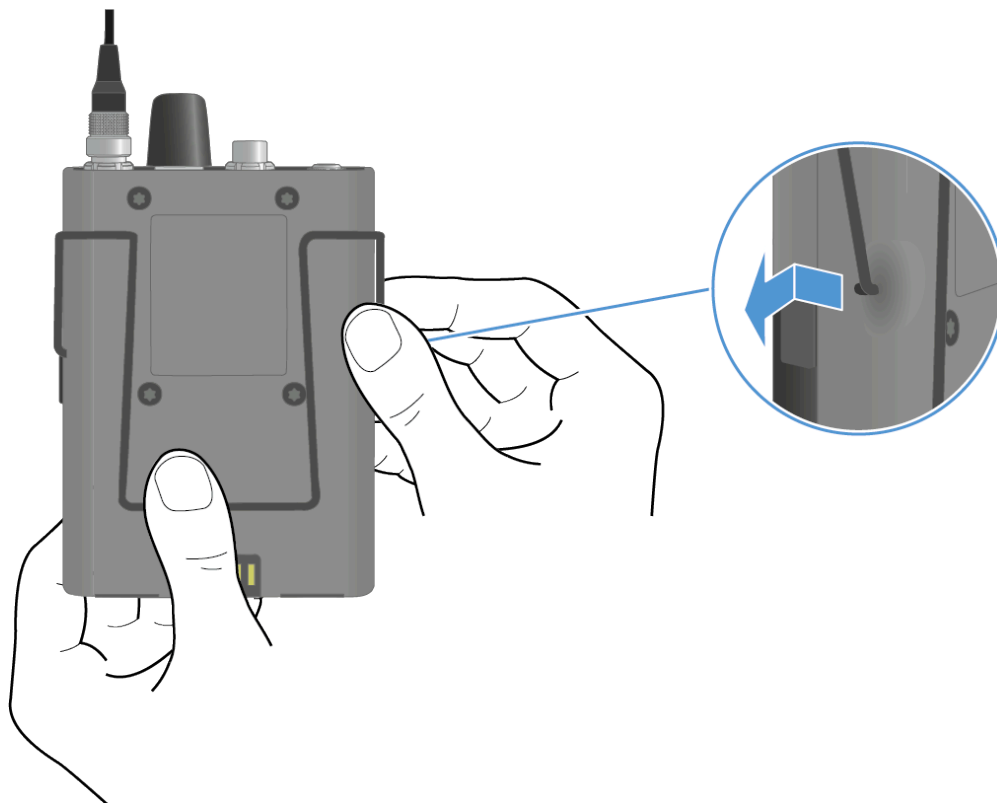



- ▶ While still holding the belt clip down, carefully pull back and then out the other side of the belt clip.

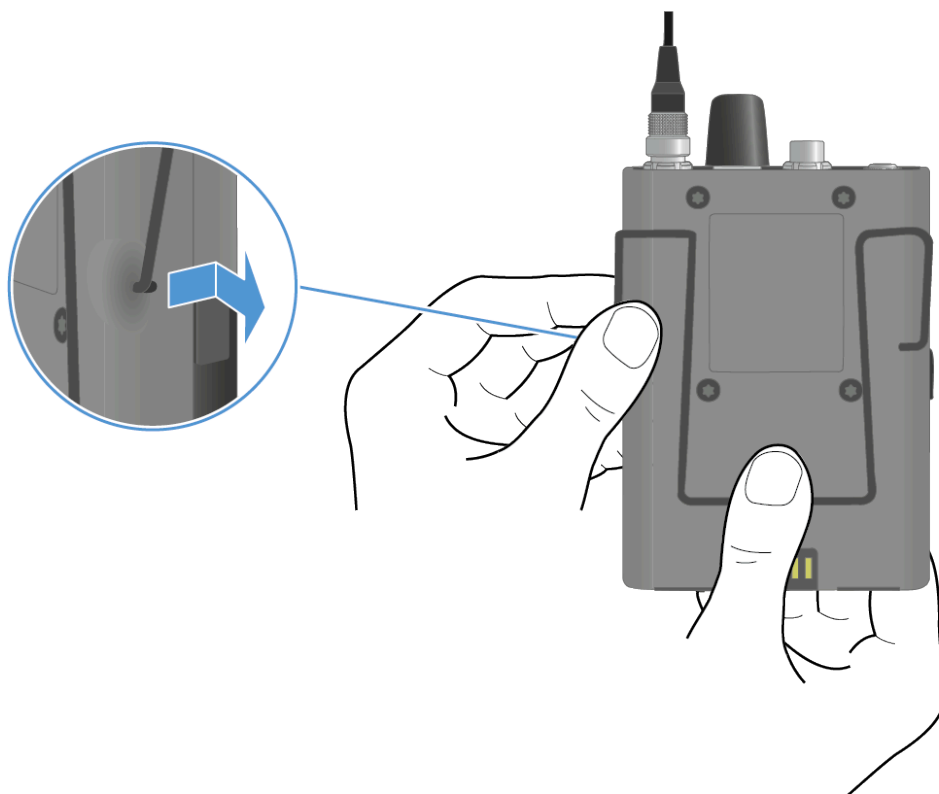

To insert the belt clip:

i Always insert one side before the other, not at the same time, as otherwise the belt clip could bend.

- ▶ Hold down the belt clip with the thumb to the housing.
- ▶ Insert one side of the belt clip first.

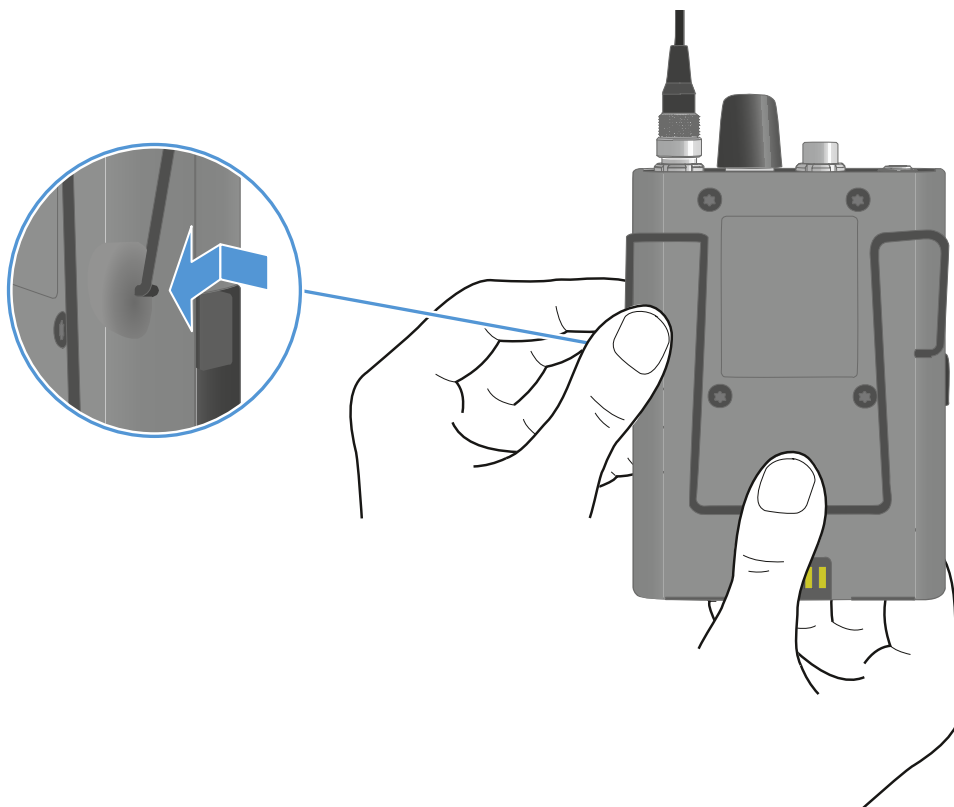

▶ Then insert the second side of the belt clip.

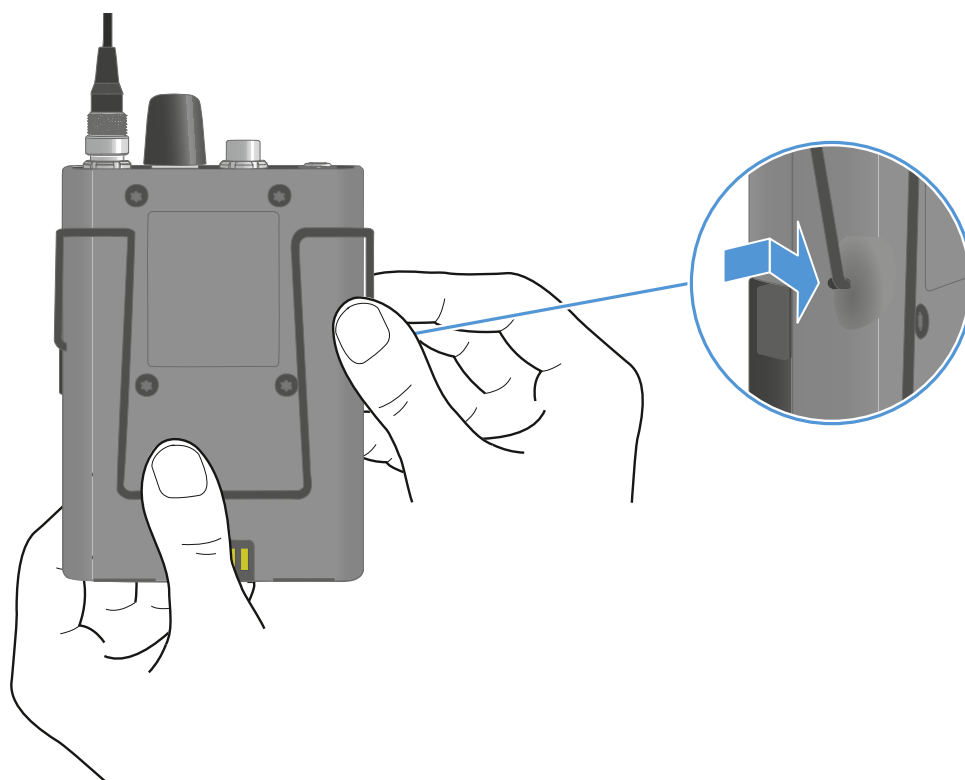



✓ The belt clip has been removed and inserted.



Meaning of the LEDs

The **Status LED** and **LEDs** can indicate the following information.

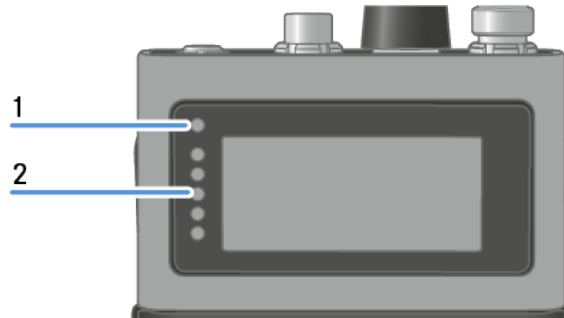





1 **Status LED**

2 **LEDs**

Status LED

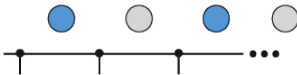
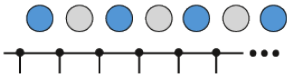
The **Status LED** provides information about the status between the SEK and Base Station, as well as status information for the SEK.

	The LED is off: <ul style="list-style-type: none">• SEK is switched off
	The LED is orange: <ul style="list-style-type: none">• SEK is starting
	The LED is flashing blue: <ul style="list-style-type: none">• Searching for a new Base Station to pair
	The LED is flashing blue quickly: <ul style="list-style-type: none">• Pairing to new Base Station is in progress• SEK turns off after five minutes, when no Base Station was found
	The LED is blue: <ul style="list-style-type: none">• Connected to new Base Station, waiting for confirmation

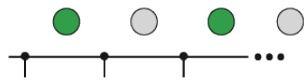

The LED is flashing green:

- SEK is searching for previously paired Base Station

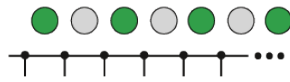

The LED is flashing green quickly:

- SEK is connecting to previous paired Base Station



The LED is green:

- SEK is on
- SEK is connected to the Base Station



The LED is pulsing green:

- SEK is in sleep mode

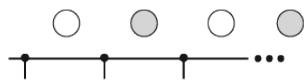

The LED is flashing white:

- Identify of SEK is in progress

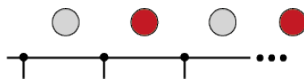

The LED is flashing red:

- Battery state is below 10 %

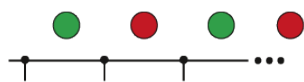

The LED is flashing green and red:

- Firmware update is in progress

LEDs

The **LEDs** provide information about the mic line input level, if a microphone or instrument is connected to the SEK.

i You have to set up an audio link in Spectera WebUI.

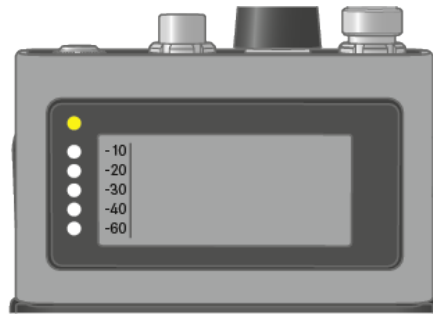
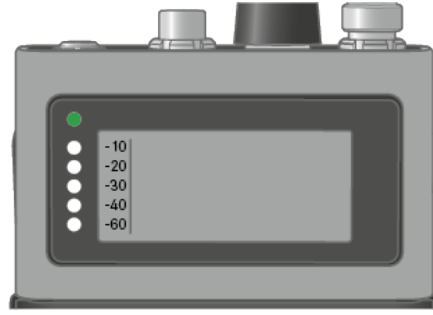

above -5 dBFS RMS

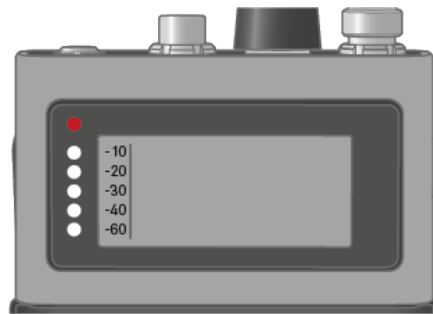

above -1 dBFS
PEAK



Switching the SEK on and off

To switch the SEK on:

- ▶ Short-press the ON/OFF button.

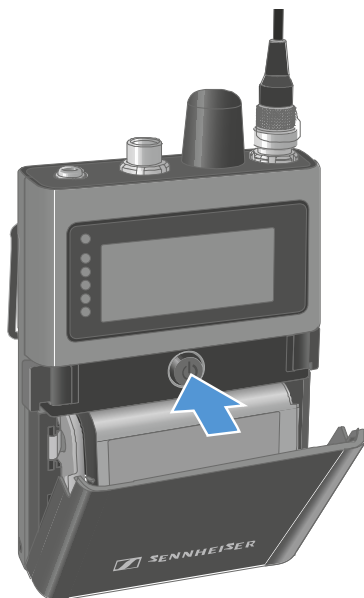

- ✓ The SEK is starting. The status LED is orange.

To put the SEK in pairing mode:

- ▶ When the SEK is off, long press the ON/OFF button.
- ✓ The SEK is searching for a new Base Station to pair. The status LED is flashing blue.

To switch the SEK off:

- ▶ Press the ON/OFF button.
- ✓ The status LED goes off.

i The display will stay on when the device is switched off or the battery has been removed.

- ✓ The SEK has been switched on/off.

When the SEK is unpaired via the software Spectera WebUI, the SEK will automatically switch into pairing mode. The status LED is flashing blue.



Sleep mode

The SEK switches to sleep mode after 5 minutes if it cannot establish a connection to the Base Station. The LED then pulses green.

Once per minute, the SEK wakes up automatically and checks whether a connection to the Base Station can be established.

Operating the jog dial wakes the SEK up immediately and it attempts to establish a connection.

In doing so, the SEK searches for a connection for 10 seconds.

If a connection is established, the SEK remains active; otherwise, it switches back to sleep mode.



Information on the display

You can view the following information on the SEKs display.

i The display will stay on when the device is switched off or the battery has been removed.

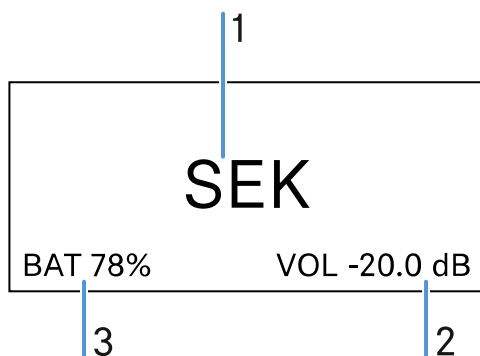

- 1 Name of mobile device
- 2 In-Ear volume level (only applicable when an audio link mode for IEM is set)
- 3 Battery status

The order of the displayed information changes depending on the setting.

- ▶ Press the rotary encoder to navigate through the menu.

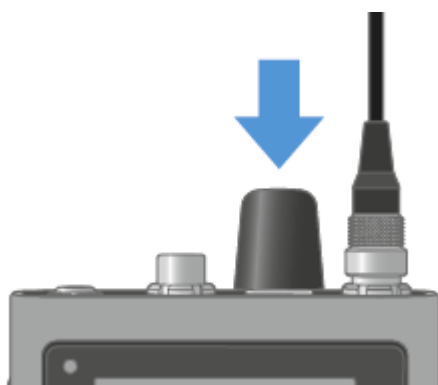

To turn on the backlight:

i No microphone or headphone is connected.

- ▶ Press the rotary encoder.
 - ✓ The backlight is on for five seconds.



To check the battery status:

i No audio link is set.

- ▶ Press the rotary encoder for two times.

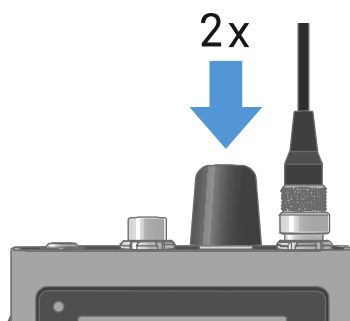

- ✔ The battery status displays for five seconds.

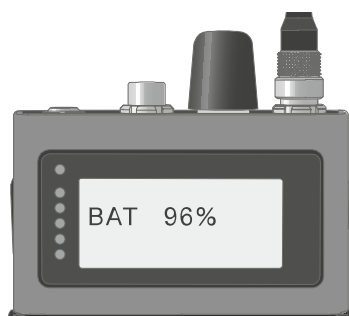

To display the headphone volume:

i Only available if in-ear audio link mode is activated.

- ▶ Press the rotary encoder.
 - ✔ The backlight is on for five seconds.
- ▶ Press the rotary encoder again within 5 seconds after the first press.
 - ✔ The headphone volume displays for five seconds.



i The volume can be altered between -100 dB to +27.5 dB in steps of 0.5 dB.

- ▶ Turn the rotary encoder slowly to change the volume.
 - ✓ The volume changes by 0.5 dB per click.
- ▶ Turn the rotary encoder quick to change the volume.
 - ✓ The volume changes dynamically in larger increments.

To display the mic/line level:

i Only available if mic audio link is activated.

- ▶ Press the rotary encoder.
 - ✓ The backlight is on for five seconds.
- ▶ Press the rotary encoder again within 5 seconds after the first press.
 - ✓ The mic/line level is displayed. The five LEDs show the input level.

To display the E-label:

i The SEK is paired to the Base Station and the activated license uses E-labels.

- ▶ Press the rotary encoder.
 - ✓ The backlight is on for five seconds.
- ▶ Press the rotary encoder till the end of the menu.
- ▶ Press the rotary encoder long for E-label screen.
 - ✓ The first page of the E-label displays.



- ▶ Press the rotary encoder again to display subsequent E-labels.
- ▶ Press the rotary encoder long to return to the information screen.
- ▶ Press the rotary encoder for two seconds to leave the E-label menu.



Pairing the SEK to the Base Station

i Mobile devices can only be paired and operated with one Base Station at a time.

You can pair up to 128 mobile devices to a Base Station within one RF channel.

Please make sure that on the Base Station

- a RF channel is configured and
- this RF channel is activated (RF on).

To pair the SEK to a Base Station:

- ▶ Put the Base Station into **Pairing Mode** using Spectera WebUI.

✓ The LED flashes blue.

i Pairing Mode is activated for five minutes. The audio signal is not interrupted.

- ▶ While the SEK is off, long-press the ON/OFF button until the Status LED is blue.

✓ The status LED is flashing blue while searching for a new Base Station.

When the SEK found the Base Station, the status LED is flashing blue quickly and then is blue.

The SEK appears in the software.

- ▶ Confirm the pairing in the software, see Spectera WebUI: **Pairing/unpairing mobile devices**.

✓ The status LED of the SEK is flashing green quickly while connecting. When connecting is completed, the status LED is green.

To unpair the SEK from a Base Station:

- ▶ The SEK can only be unpaired in Spectera WebUI.

- Spectera WebUI: **Pairing/unpairing mobile devices**

✓ The SEK will automatically switch to pairing mode. The status LED is flashing blue.

✓ The SEK has been paired to a Base Station.



Updating the SEK

You can update the firmware of the SEK via Spectera WebUI.

All Spectera devices must use the same firmware version. The Base Station determines the firmware version.

NOTICE



Data loss during firmware update

The audio transmission is interrupted during the firmware update of the Base Station, the antenna or the mobile device.

After the firmware update, the device is restarted automatically.

- ▶ Do not update the firmware during an active live audio transmission.

The remaining battery state must be higher than 10 % to start the update.

To update the firmware:

- ▶ If you want to update the SEK via Spectera WebUI: **Updating the firmware (mobile devices)**.
 - ✓ The Status LED is flashing green and red during the update.

✓ The firmware has been updated.



DAD

Product overview

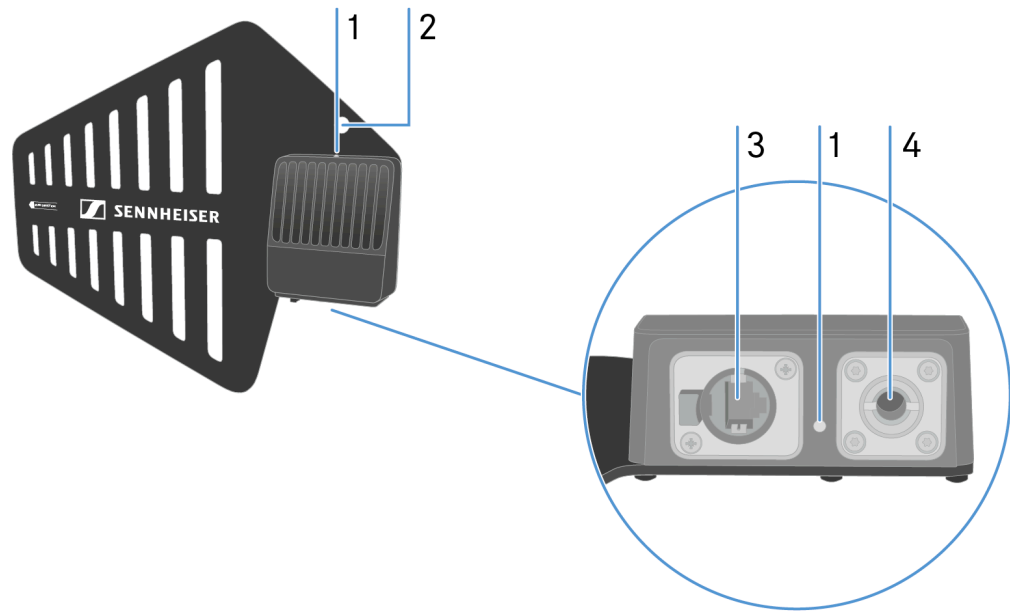

- 1 LED to indicate the status
see [Meaning of the LED](#)
- 2 Hole for rigging safety cable
- 3 Ruggedized RJ45
see [Connecting/disconnecting the antenna](#)
- 4 Microphone stand
see [Information on antenna setup](#)



Information on antenna setup

i Handle with care: The antenna contains electrical components.

Setup with other antennas

- Keep a distance more than 10 m (393.7") between the antenna and another antenna.
- Keep a distance more than 0.5 m (19.69") between the antenna and a wall.

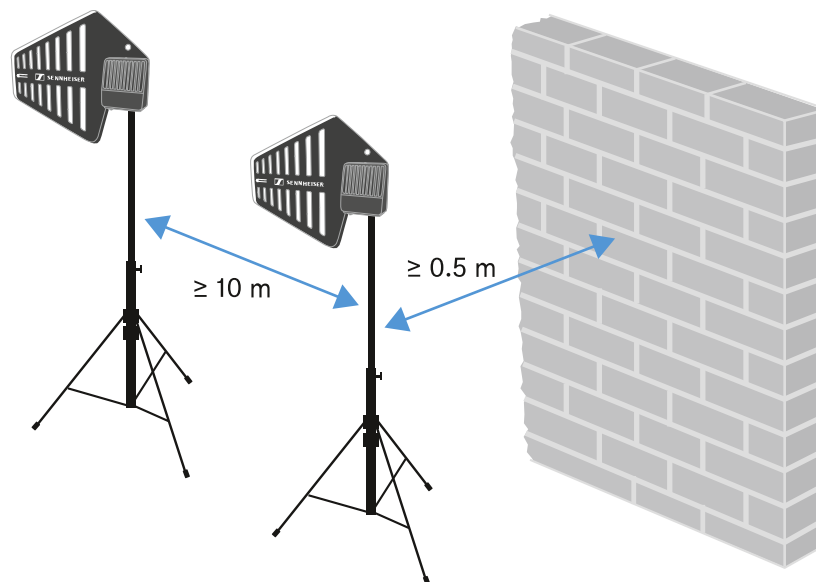

Setup with a mobile device

- Keep a distance more than 5 m (169.85") between the antenna and the mobile device.

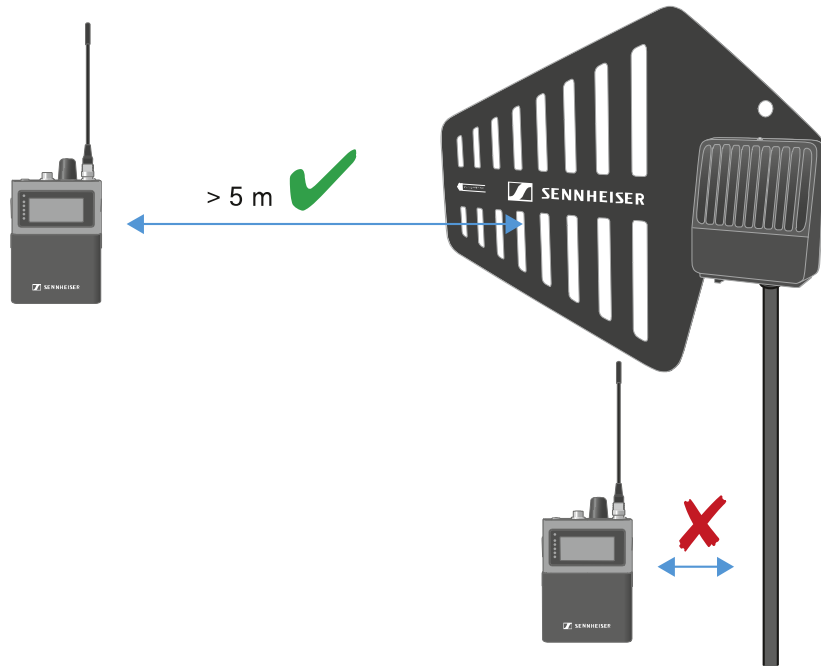



Meaning of the LED

The LED on top and below indicates the same information.



The LED is off:

- The antenna is not connected to the Base Station.

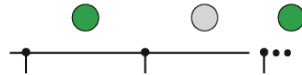

The LED is flashing green:

- The antenna is connecting to the Base Station.



The LED is green:

- The antenna is connected to the Base Station and one or both RF channels are active.



The LED is yellow:

- The antenna is connected to the Base Station and one or both RF channels are muted.

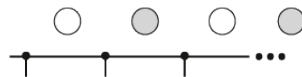

The LED is flashing white:

- The connected antenna is identified.

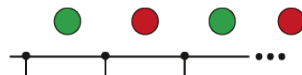

The LED is flashing green and red:

- Firmware update is in progress.



Placing on a stand

The thread is suitable for mounting on a standard microphone stand with 3/8" or 5/8" thread.

i Handle with care: The antenna contains electrical components.

CAUTION



Personal injury and damage to property if the antennae should tip or fall over

If you do not secure the antennae against tipping or falling over, they may cause personal injury and damage to property.

- ▶ Secure antennae so that they cannot tip and fall over. Use safety wires for this purpose. The safety wires, rope terminations and coupling links must comply in their dimensioning and condition with the regulations and standards of the country in which they are used!



To place the DAD on a stand:

- ▶ Screw the DAD to the stand.
- ▶ Make sure to use the correct hole!

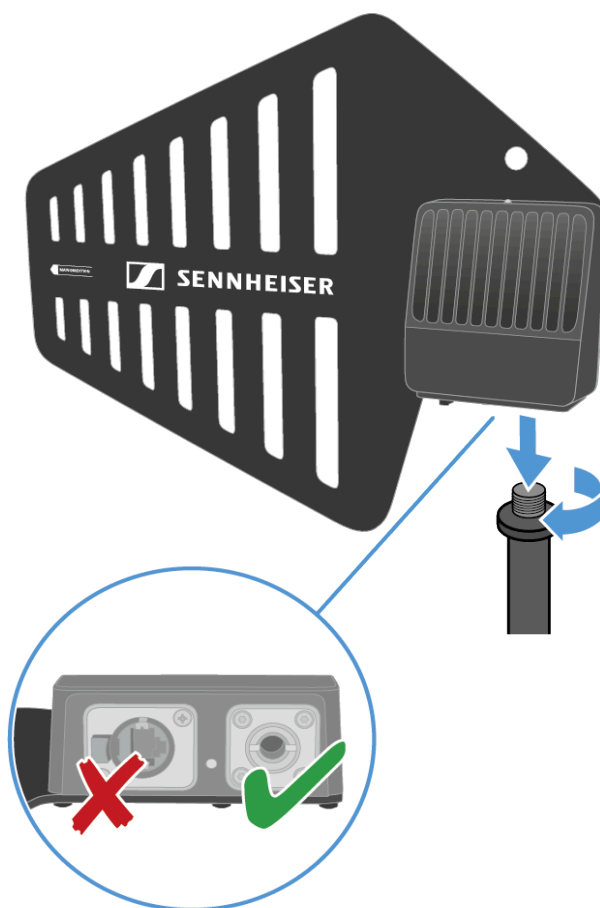

✓ The DAD has been placed on a stand.



Connecting/disconnecting the antenna

The cable supplies power and exchanges data.

i Handle with care: The antenna contains electrical components.

The cable must

- be a CAT5e or higher,
- have ruggedized plugs and
- not extend 100 m (3937").

i We recommend using an antenna cable cat 5e (see [Accessories for the DAD](#)).

To connect the antenna to the Base Station:

- ▶ Observe the information: [Information on antenna setup](#).

i The antenna must be connected directly to the Base Station, with no switch in between.

- ▶ Plug on side of the cable into the antenna.
- ▶ Make sure to use the correct hole!

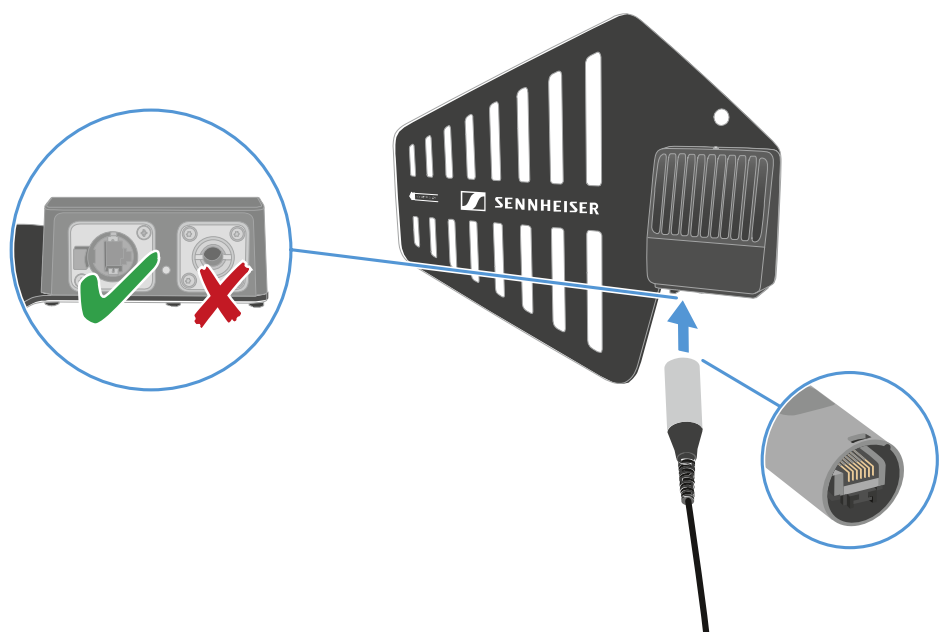



- ▶ Plug the other side of the cable into one antenna port (A, B, C or D) at the rear site of the Base Station.

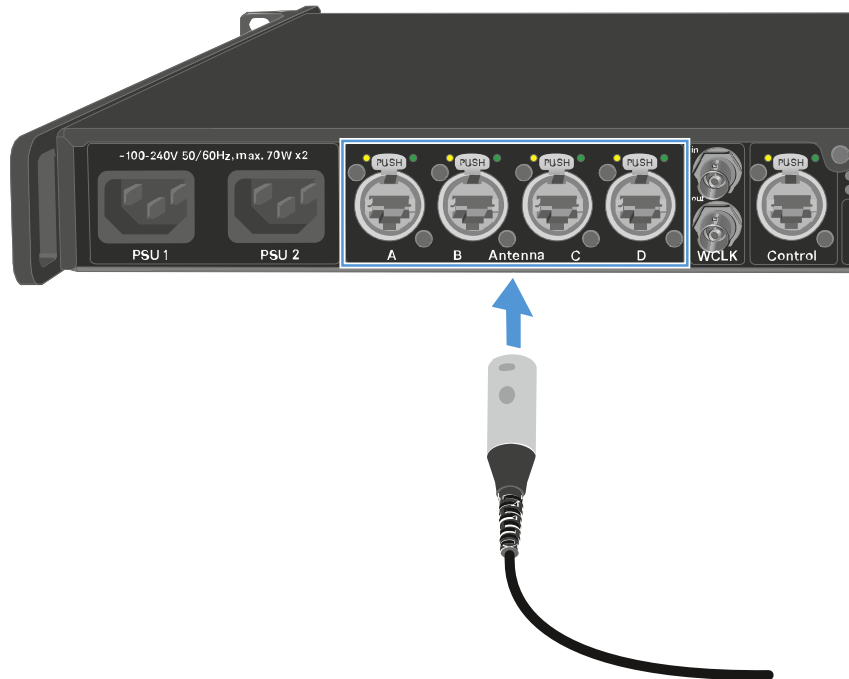

- ✓ The LED flashes green to connect to the Base Station.

The LED is green, when the antenna is connected to the Base Station and one or both RF channels are active.

Or the LED is yellow, when the antenna is connected to the Base Station and the radio signal is muted.

Or the LED is flashing green and red, when the firmware is updating automatically.

i If the Base Station is in standby, the DAD is off.

- ▶ You can connect up to four antennas to one Base Station.

The Base Station has two independent RF channels. Both variants of the antenna (UHF and 1G4) can be connected to the Base Station at the same time.

To disconnect the antenna from the Base Station:

- ▶ Hold the push button down.
- ▶ Unplug the cable from the Base Station.



To disconnect the cable from the antenna:

- ▶ Hold the snap-in nose down.

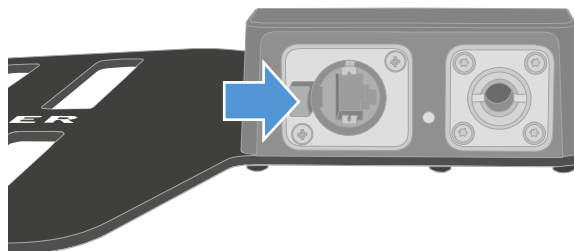

- ▶ Unplug the cable from the antenna.

✓ The antenna has been connected/disconnected.



Antenna cable extension

Longer cable distances are possible with the use of fiber optic cables and media converters.

Sennheiser tested the recommend converters for a complete distance of 4 km (157480.31").

We only recommend the following converters for fully tested functionality:

i It is mandatory to use the media converters in pairs.

- Lantronix M/GE-PSW-PSE-01 (with PoE for DAD) **or**
- Lantronix M/GE-T-SFP-01 (needs a Class 2 PoE injector capable of supplying powering to the DAD (power consumption < 6.5 W)) **or**
- Barnfind Technologies BarnColor 4xEth (with PoE for DAD) **or**

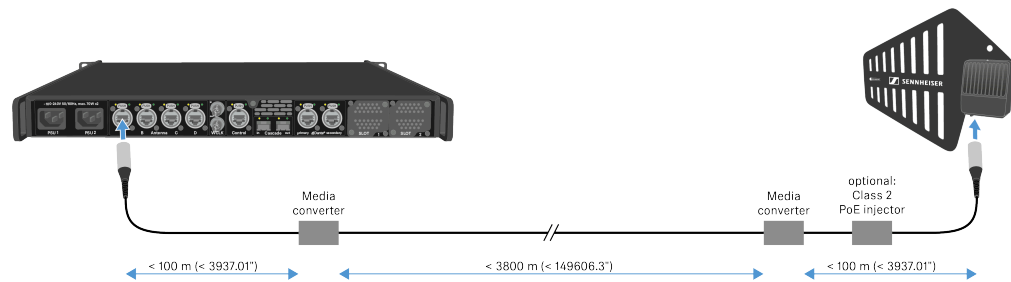

i The media converter must not have a switch function.



Updating the DAD

The firmware of the antenna will update automatically, when connected to the Base Station.

NOTICE



Data loss during firmware update

The audio transmission is interrupted during the firmware update of the Base Station, the antenna or the mobile device.

After the firmware update, the device is restarted automatically.

- ▶ Do not update the firmware during an active live audio transmission.

To update the firmware:

- ▶ Connect the antenna to a Base Station. See [Connecting/disconnecting the antenna](#). To update the Base Station, see [Updating the Base Station](#).
- ✓ The LED is flashing green and red during the update.

✓ The firmware has been updated.



CHG 70N-C charger

The CHG 70N-C is a network enabled charger featuring two individual charging bays.

Compatible products:

- EW-DX SKM/EW-DX SKM-S handheld transmitter
- EW-DX SK/EW-DX SK 3-PIN bodypack transmitter
- SPECTERA SEK bidirectional transmitter
- BA 70 rechargeable battery

Product overview

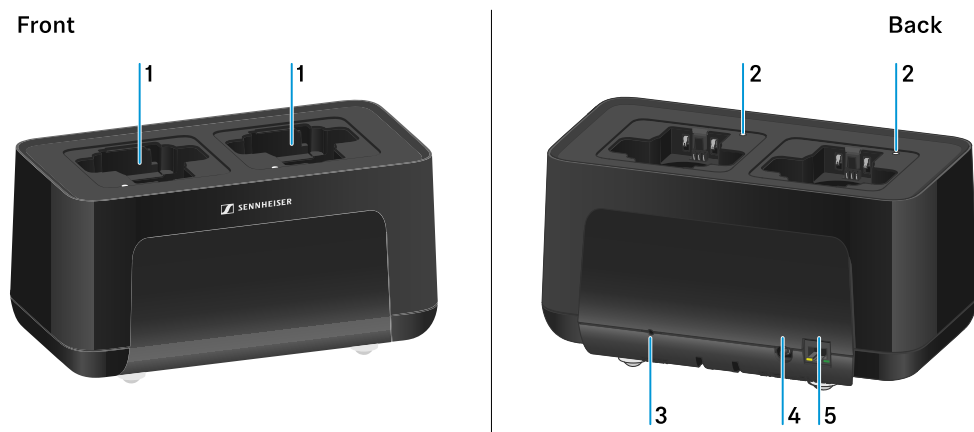

1 Charging slots

- See [Charging the rechargeable battery](#)

2 Status LED of the charging slots

- See [Charging the rechargeable battery](#)

3 Reset button

- Press and hold for 10 seconds to reset the device's network settings, see [Connecting a charger in a network](#)
- Press and hold for 4 seconds to enable power saving mode, see [Power saving mode](#)

4 DC in connection socket for the NT 12-35 CS power supply unit

- See [Connecting/disconnecting the charger to/from the power supply system](#)



5 PoE/Ethernet RJ45 socket for controlling the device over the network and for Power over Ethernet power supply

- See [Connecting a charger in a network](#)
- See [Connecting/disconnecting the charger to/from the power supply system](#)

i You can cascade up to 5 devices with only one power supply and one network connection. See [Cascading chargers](#).



Connecting/disconnecting the charger to/from the power supply system

You can operate the charger either with the Sennheiser NT 12-35 CS power supply unit or with Power over Ethernet (PoE IEEE 802.3af Class 0). Please refer to the following information.

Power from the NT 12-35 CS power supply unit

- ▶ Use only the **NT 12-35 CS** power supply unit from Sennheiser. It is designed for your charger and ensures safe operation.

i The power supply unit is available either separately (Sennheiser article number 508995) or together with the charger as a kit (see [CHG 70N-C network-enabled charger](#)).

Power from the NT 12-35 CS power supply unit

i Use only the **NT 12-35 CS** power supply unit from Sennheiser. It is designed for your charger and ensures safe operation. The power supply unit is available either separately (Sennheiser article number 508995) or together with the charger as a kit (see [CHG 70N-C network-enabled charger](#)).

- ▶ Connect the hollow jack plug of the power supply unit to the **DC in** socket on the charger.
- ▶ Pass the cable through the strain relief.
- ▶ Plug the power supply unit into the wall outlet using the correct power cable for your country.

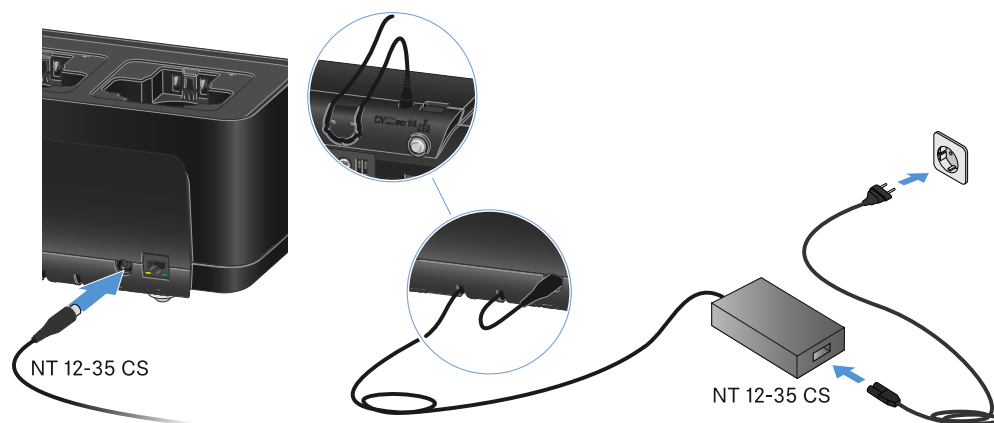



Disconnecting the charger completely from the power supply system

- ▶ Unplug the mains cable from the wall socket.
- ▶ Unplug the hollow jack plug of the power supply unit from the **DC in** socket on the charger.

Power over Ethernet (PoE)

i The charger can be powered via **Power over Ethernet** (PoE IEEE 802.3af Class 0).

- ▶ Connect the charger to a **PoE-enabled** network switch.

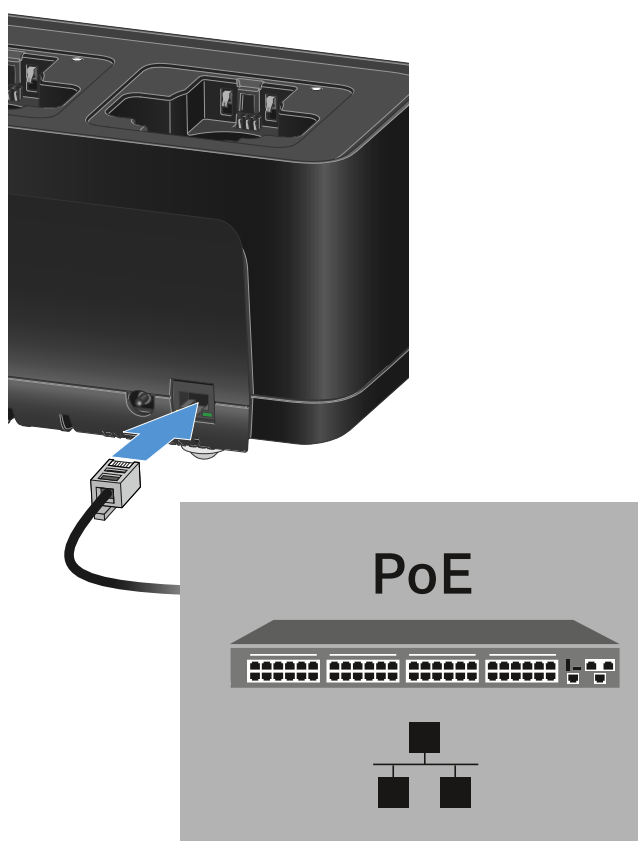



Connecting a charger in a network

You can monitor and control one or more chargers via a network connection using the **Sennheiser Control Cockpit (SCC)** software.

- i** The network does not have to be a homogeneous network including only chargers. You can integrate the charger into your existing network infrastructure with any other types of devices.

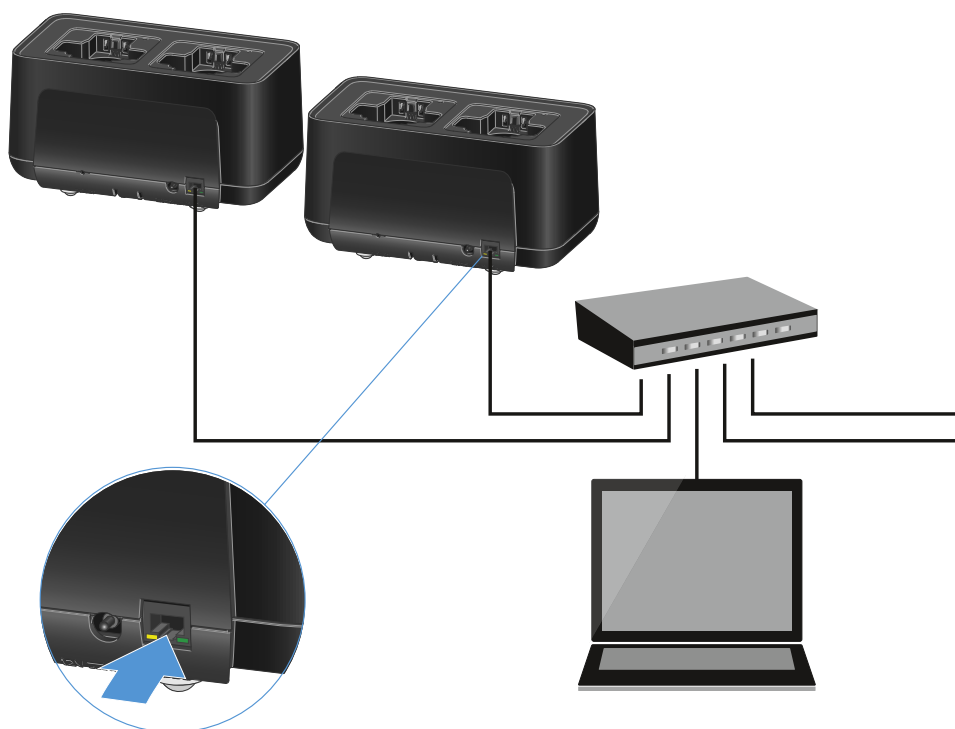

You can integrate the devices into the network individually or cascade up to 5 chargers (see [Cascading chargers](#)).

To reset the network settings to their factory defaults:

- ▶ Hold the **Reset** button for 4 seconds.

- i** For more information about controlling devices via the Sennheiser Wireless Systems Manager or Sennheiser Control Cockpit software, refer to the instruction manual for the software. You can download the software here: sennheiser.com/control-cockpit



Cascading chargers

You can cascade up to five CHG 70N-C chargers and operate them with a single power supply and a single network connection. This minimizes the cabling required for larger systems.

- i** The power must be supplied via the NT 12-35 CS power supply unit. Power over Ethernet (PoE) is not possible when cascading.

To cascade the chargers:

- ▶ Make sure that no chargers are connected to the power before you start.
- ▶ Plug the chargers into each other as shown in the figure.

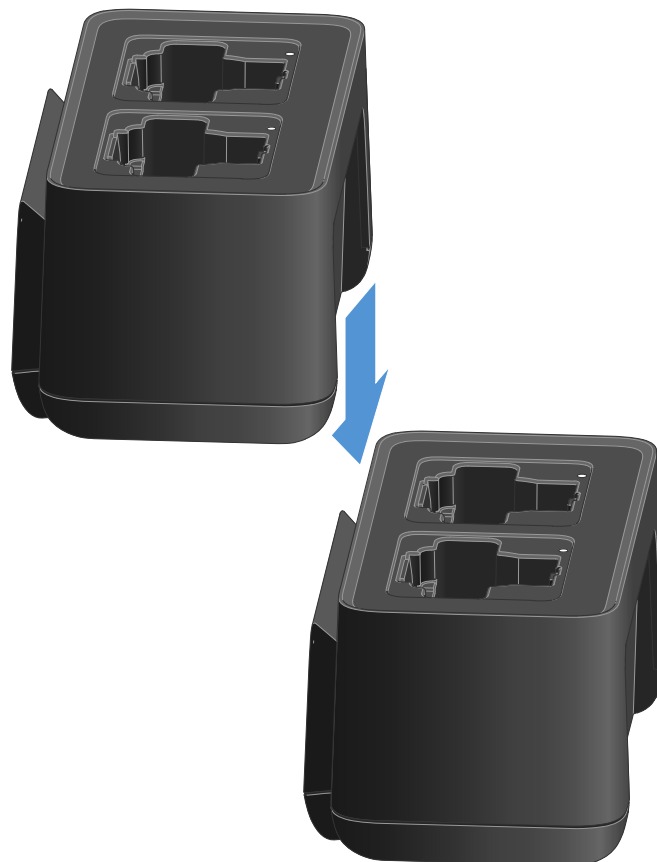

- ▶ Detach the connecting rail on the bottom of the charger.
- ▶ Fasten the connecting rail beneath two chargers as shown in the figure.
- ✓ The power and the network connection are passed on to all devices via the connecting rails.

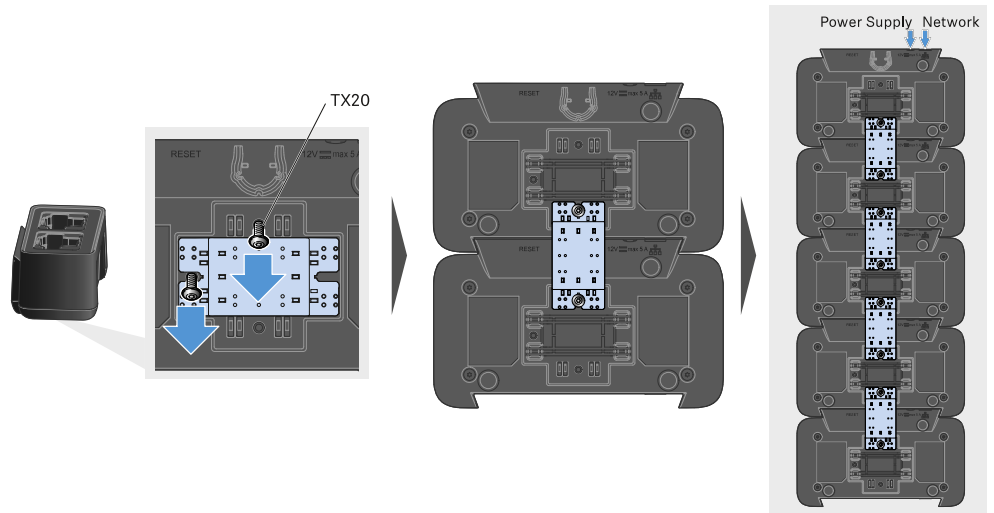

- ▶ Connect the first charger in the cascade to the network (see [Connecting a charger in a network](#)).
- ▶ Finally, connect the NT 12-35 CS power supply unit to the first charger in the cascade (see [Connecting/disconnecting the charger to/from the power supply system](#)).

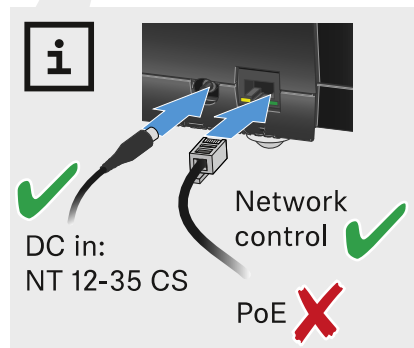



Charging the rechargeable battery

You can use the CHG 70N-C charger to charge individual BA 70 rechargeable batteries, or to charge EW-DX SKM, EW-DX SKM-S, EW-DX SK, EW-DX SK 3-PIN or Spectera SEK with the BA 70 rechargeable battery already inserted.

To charge the battery:



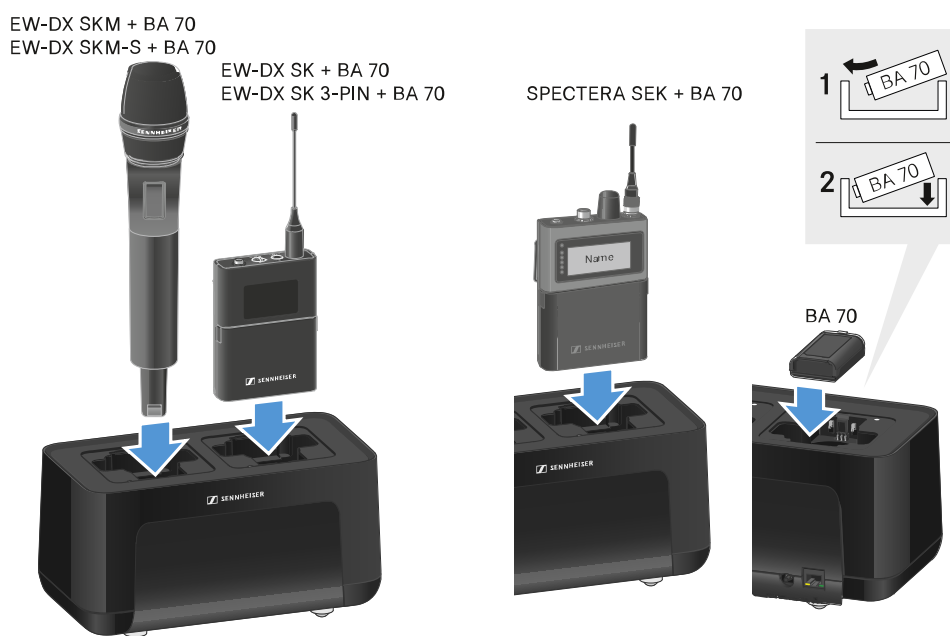



- ▶ Insert the individual rechargeable battery or the transmitter with battery already inserted into the charging slot as shown in the figure.

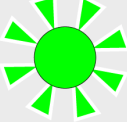

- ✓ The rechargeable battery will begin charging.

The LED on the charging slot shows the battery's charge level.



LEDs	
	100 %
	> 60 %
	> 20 %
	> 0 %
	Error



Power saving mode

In power saving mode, the transmitters are charged only once. The charger also does not provide any trickle charge.

To activate power saving mode:

i In power saving mode, the CHG 70N-C cannot be controlled over the network.

- ▶ Remove all transmitters and/or rechargeable batteries from the charging slots.
- ▶ Hold the **Reset** button for 4 seconds.
 - ✓ The charging slot LEDs light up purple.
- ▶ Insert the rechargeable battery/transmitter for charging.
 - ✓ The rechargeable battery will begin charging. The charging slot LED turns green once it reaches full charge.

To deactivate power saving mode:

- ▶ Disconnect the charger from the power supply system.
- ▶ Then reconnect it to the power supply system.
 - ✓ The charger will start up in the configuration that was set before you activated power saving mode.



Updating the firmware of the charger

You can update the charger firmware using the **Sennheiser Control Cockpit** software.



i Note on firmware version 4.0.0

Devices with outdated firmware can no longer be reached in a cascade if the first charger has the new firmware.



- ▶ Disconnect the chargers from the cascade.

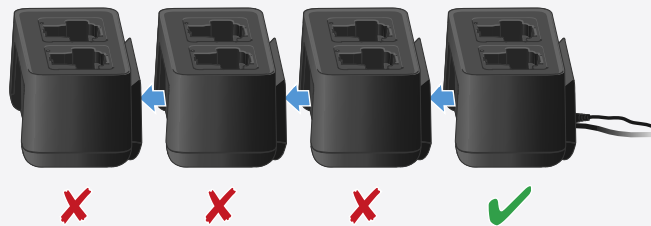

- ▶ Update the firmware of each charger individually.

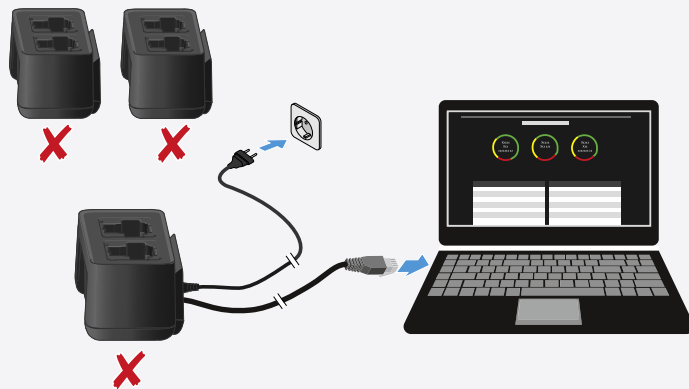

- ▶ Connect the chargers.





Updating with the Sennheiser Control Cockpit:

- ▶ Connect the charger to a network (see [Connecting a charger in a network](#)) and establish the connection with the software.

i For more information about controlling devices with the **Sennheiser Control Cockpit** software, refer to the software help. You can download the software here:
sennheiser.com/control-cockpit



L 70 USB charger

Connecting/disconnecting the charger to/from the power supply system

To connect the charger to the power supply system:

- ▶ Use only the **NT 5-20 UCW** power supply unit from Sennheiser.
- ▶ Connect the USB-C plug on the charging cable to the USB-C port on the side of the charger.
- ▶ Plug the power supply unit with the correct country adapter into a suitable power outlet.

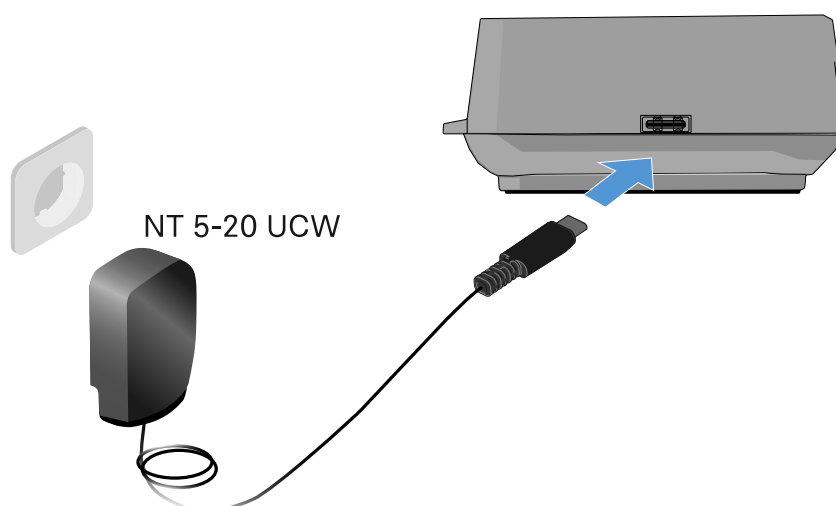

To disconnect the charger from the power supply system:

- ▶ Unplug the power supply unit from the wall socket.
- ▶ Remove the USB-C plug on the charging cable from the USB-C port on the side of the charger.



Charging the rechargeable battery

To charge the BA 70 rechargeable battery in the L 70 USB charger:



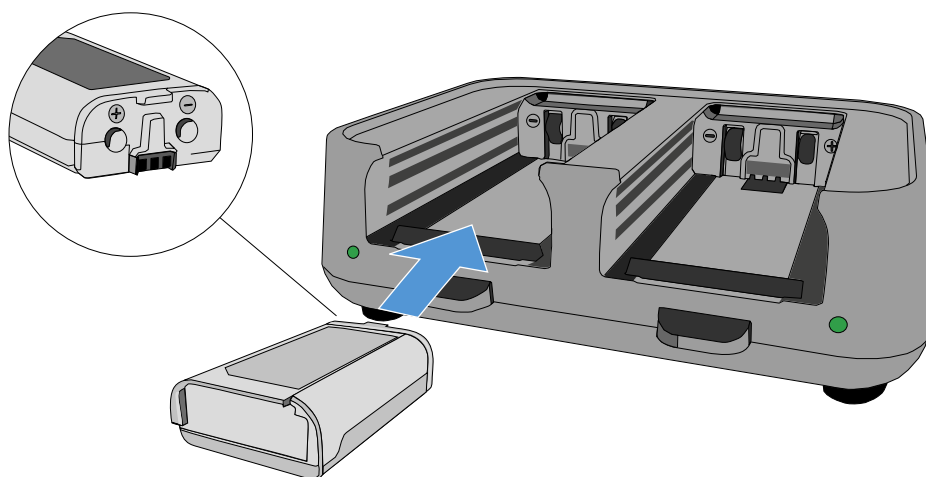



- ▶ Slide the rechargeable battery completely into the charging slot as shown in the figure.

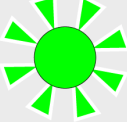

- ✔ The rechargeable battery will begin charging.

The LED on the charging slot shows the battery's charge level:



LEDs	
	100 %
	> 60 %
	> 20 %
	> 0 %
	Error



Modular L 6000 charger

These sections contain information about installing, starting up and operating the modular L 6000 charger and the corresponding charging modules.

Product overview

Front

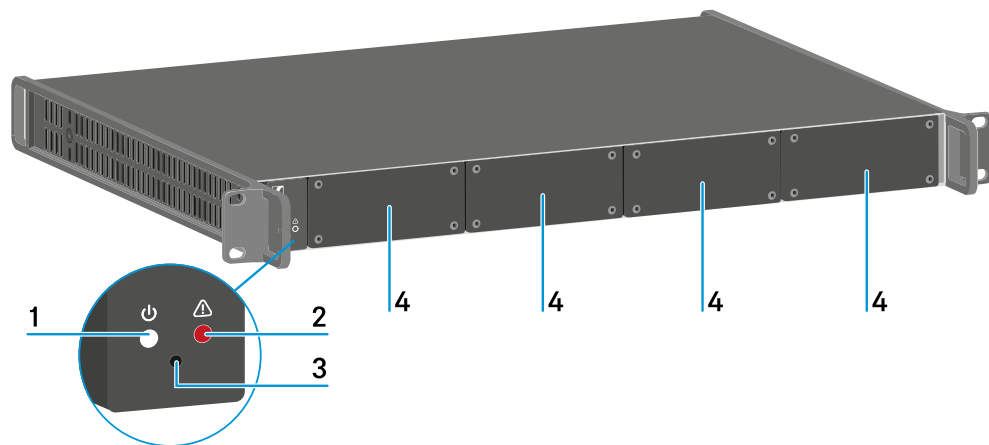

1 Power status LED

See [Meaning of the LEDs](#)

2 Warning status LED

See [Meaning of the LEDs](#)

3 Reset

See [Resetting settings \(factory reset\)](#)

4 Dummy caps

See [Installing a charging module in the L 6000 charger](#)

Back

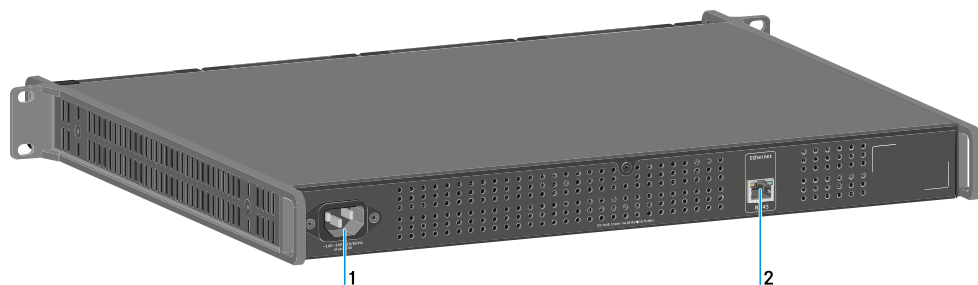

1 Power socket

See [Connecting/disconnecting the L 6000 to/from the power supply system](#)



2 Ethernet socket

See [Connecting the L 6000 to a network](#)



Connecting/disconnecting the L 6000 to/from the power supply system

To connect the L 6000 to the power supply system:

- ▶ Connect the mains cable IEC connector to the power socket on the rear side of the L 6000.
- ▶ Connect the mains cable plug into a suitable wall socket.

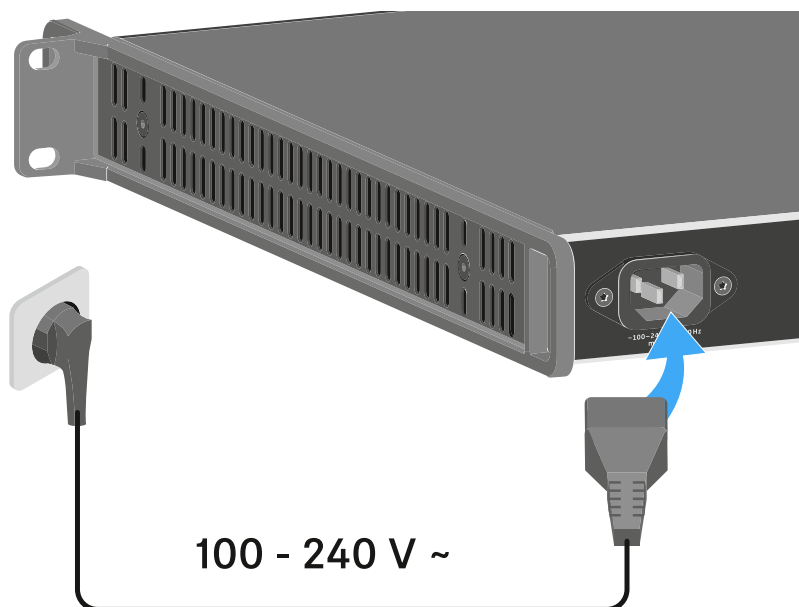

To completely disconnect the L 6000 from the power supply system:

- ▶ Unplug the mains cable plug from the wall socket.
- ▶ Unplug the mains cable IEC connector from the power socket on the rear side of the L 6000.



Connecting the L 6000 to a network

You can monitor and control one or more L 6000s via a network connection using the **Sennheiser Wireless Systems Manager (WSM)** software.

The network does not have to be a homogeneous network including only chargers. You can integrate the L 6000 into your existing network infrastructure with any other types of devices.

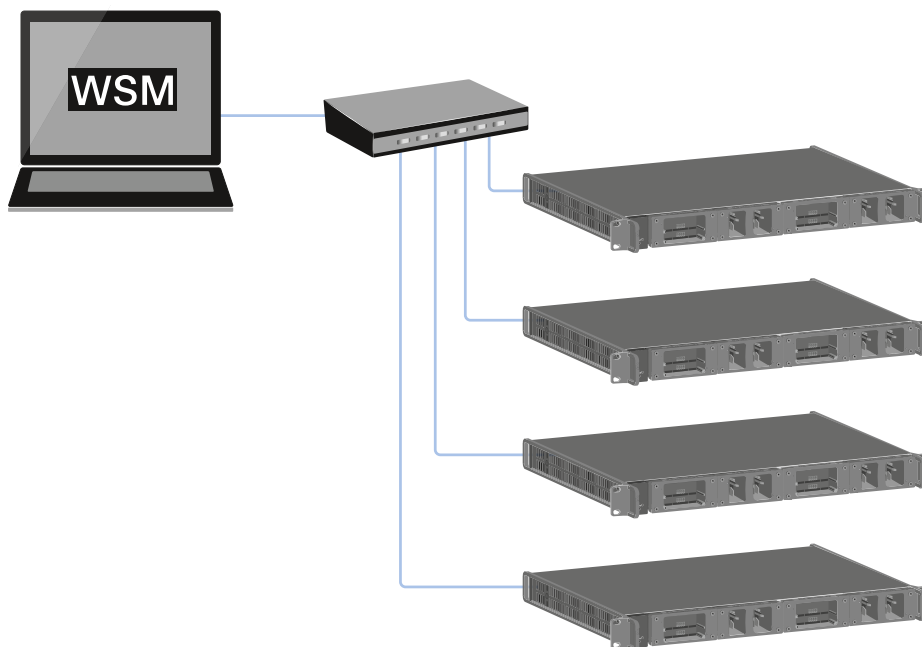



To connect the L 6000 to a network:

- ▶ Connect a network cable with an RJ-45 connector (Cat5 at minimum) to the **Ethernet** socket on the rear side of the L 6000.

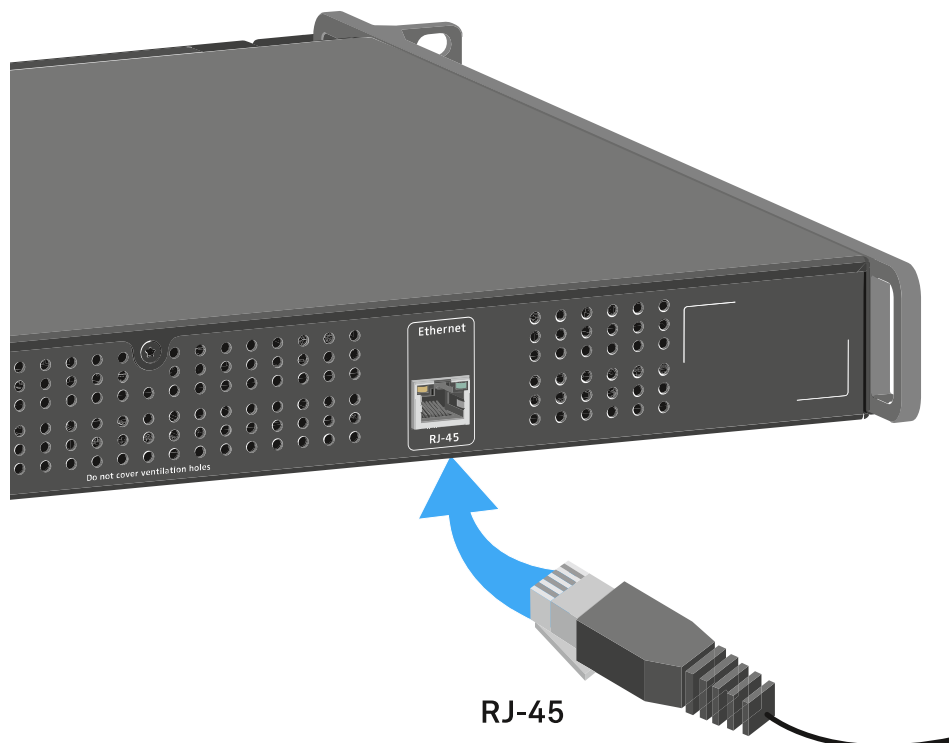

i For more information about controlling devices via the **Sennheiser Wireless Systems Manager (WSM)** software, refer to the instruction manual for the software. You can download the software here: sennheiser.com/wsm



Installing a charging module in the L 6000 charger

The following charging modules are available for the L 6000 charger.

- **LM 6060** -> for charging the **BA 60** rechargeable battery

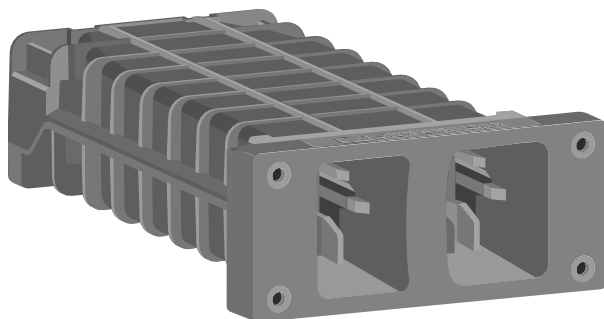

- **LM 6061** -> for charging the **BA 61** rechargeable battery

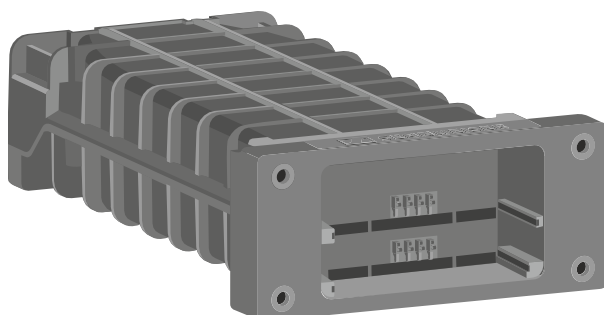

- **LM 6062** -> for charging the **BA 62** rechargeable battery

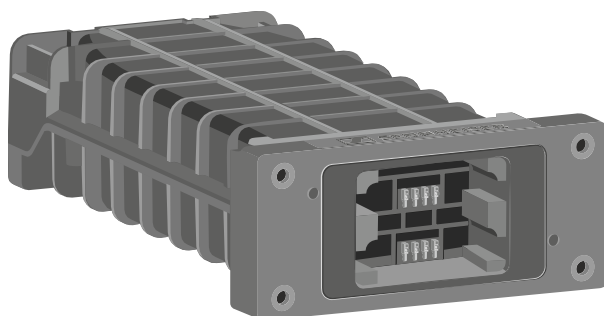

- **LM 6070** -> for charging the **BA 70** rechargeable battery

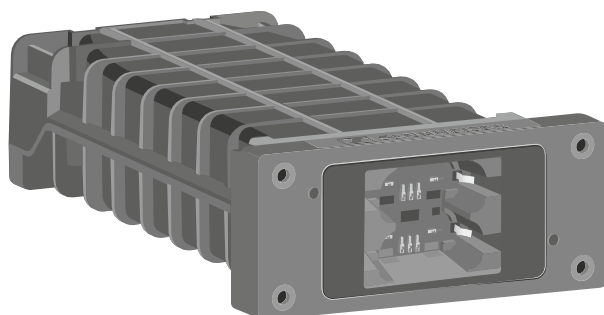



You can combine the LM 6060, LM 6061, LM 6062 and LM 6070 in any way in the L 6000 charger.

To install a charging module in the L 6000 charger:

- ▶ Completely disconnect the L 6000 charger from the power supply system. See [Connecting/disconnecting the L 6000 to/from the power supply system](#).
- ▶ Unscrew one of the dummy caps on the L 6000. To do so, you require a Torx 10 screwdriver.

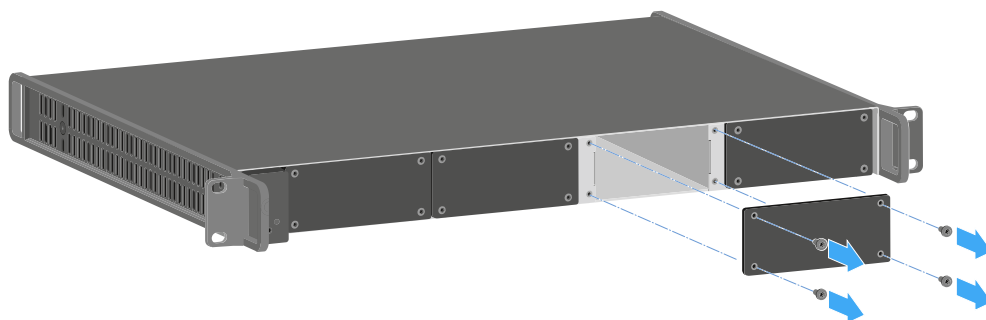

- ▶ Fully slide the charging module into the open charging slot as shown in the figure.
 - ✓ The charging module can be inserted into the L 6000 housing only in one direction. The Sennheiser lettering on the charging module must face upward.

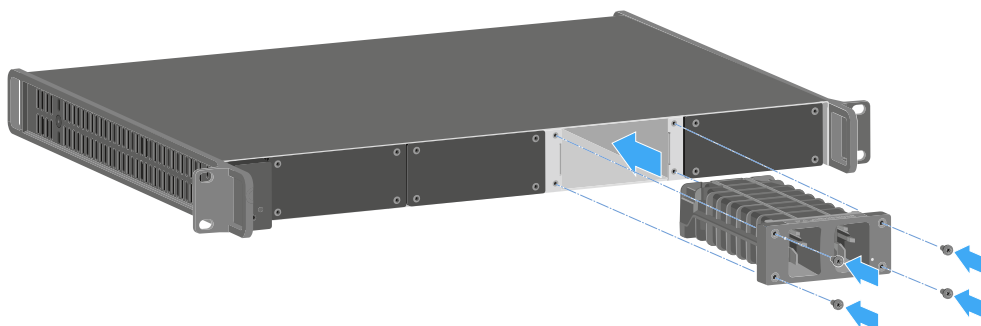

- ▶ Tightly screw on the charging module.

Always use the latest firmware for the L 6000 charger (version 2.0 or later) to ensure you have access to the full range of functions. You can download the latest firmware from the following address:

sennheiser.com/l-6000

i For more detailed information about charging the BA 60, BA 61 and BA 62 and BA 70 rechargeable batteries, see [Charging the rechargeable batteries in the L 6000 charger](#).



Installing the L 6000 in a rack

You can install the L 6000 charger in any conventional 19" rack.

The rack mounting angles are already attached to the device.

Always observe the following information during rack mounting.

NOTICE



Material damages caused by devices overheating

When there is insufficient ventilation, the devices mounted in the rack may overheat.

- ▶ Ensure that there is sufficient ventilation in the rack, particularly if several devices are installed.
- ▶ If necessary, install a fan in the rack.

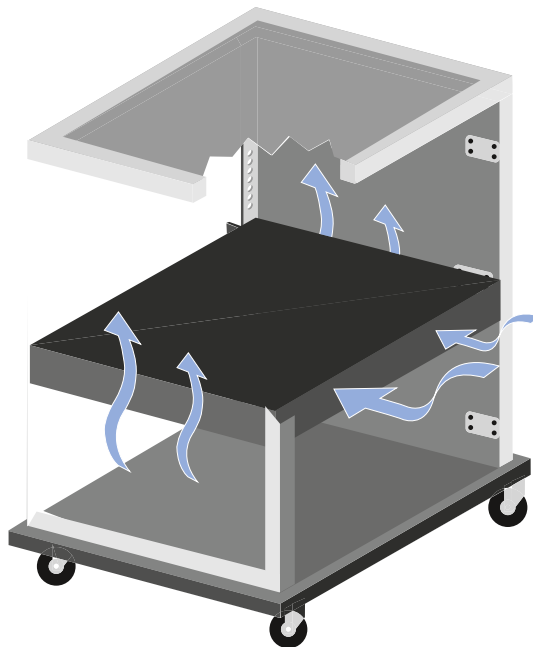



- ▶ Support the EM 6000 after installation in the rack. Due to the weight and depth of the device, there is a risk that it may break off in the rack and become damaged as a result.

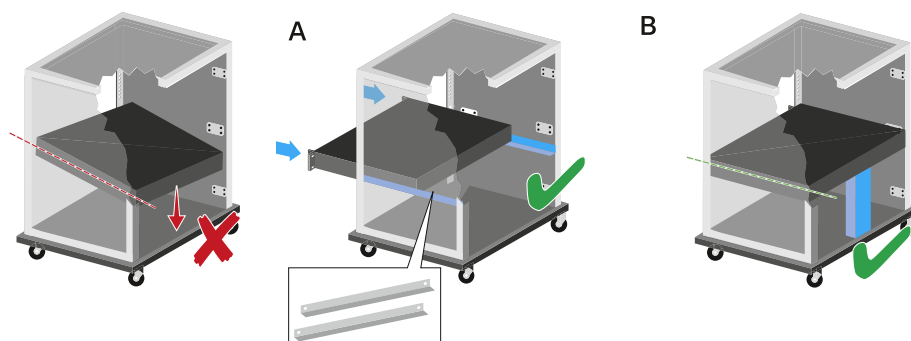

Version A:

- ▶ Use special rack mounting rails.
- ▶ The design of the rack used must be suitable for the installation of these mounting rails.

Version B:

- ▶ Use a suitable object to support the device on the rear side.
- ▶ Ensure that this object cannot become loose.



Switching the L 6000 on and off

The L 6000 does not have a separate on/off switch.

Once the power supply is established, the device is switched on.

- ▶ See [Connecting/disconnecting the L 6000 to/from the power supply system](#).



Charging the rechargeable batteries in the L 6000 charger

To charge the BA 60, BA 61, BA 62 and BA 70 rechargeable batteries with the L 6000 charger, you need the LM 6060, LM 6061, LM 6062 or LM 6070 charging modules.

Before charging, you have to install the charging modules in the L 6000 charger. For installation information, see [Installing a charging module in the L 6000 charger](#).

i **Note on the charger firmware**

Always use the latest firmware for the L 6000 charger (version 2.0 or later) to ensure you have access to the full range of functions. You can download the latest firmware from the following address:

sennheiser.com/l-6000

i **Note on the BA 62 rechargeable battery for the SK 6212 bodypack transmitter**

It is possible that new rechargeable batteries cannot be fully charged to 100 % in the first few charging cycles.

The remaining operating time may still be unclear after the first few charging cycles. This will improve over time after more charging cycles because the rechargeable battery calibrates itself.

NOTICE



Damage to the charging contacts in the charging slot

If you touch the contacts in the charging slot, they may become dirty or bent.

- ▶ When replacing and removing the rechargeable batteries, ensure that you do not touch the charging contacts in the charging slots.



To charge the rechargeable batteries:

- ▶ Insert the rechargeable battery into the charging module as shown in the figure until it audibly clicks into place.
- ✓ The rechargeable batteries can be inserted into the charging modules only in one direction. You can see the charge level of the rechargeable batteries from the LEDs on the charging modules (see [Meaning of the LEDs](#)).

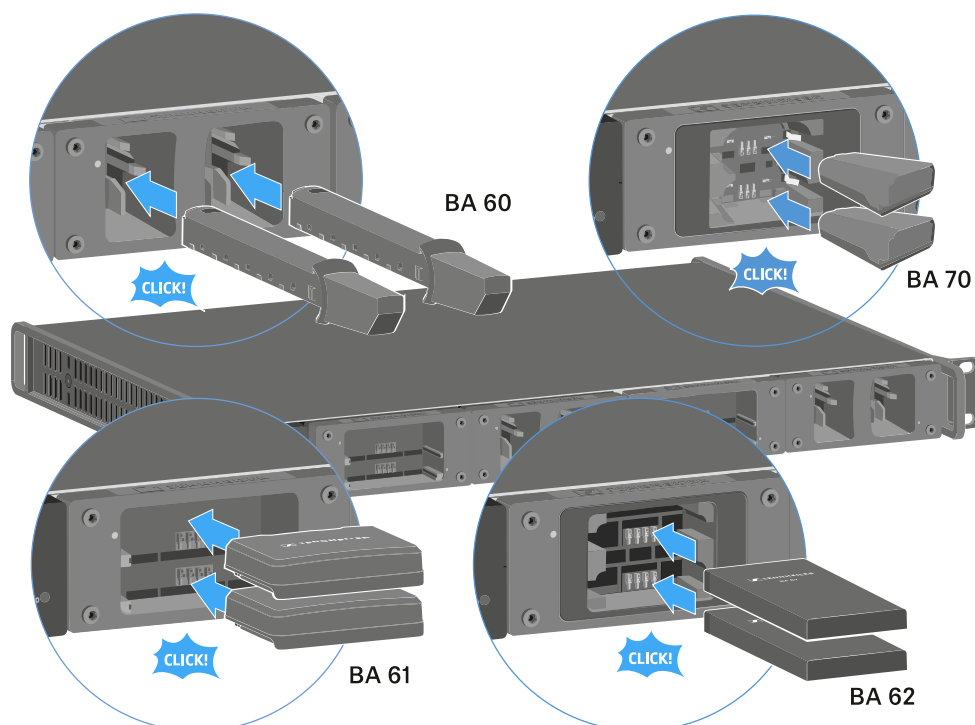

i At ambient temperatures of 45° C (113° F) and above, the rechargeable batteries can no longer be fully charged. They can only be charged to a maximum of 70 %.









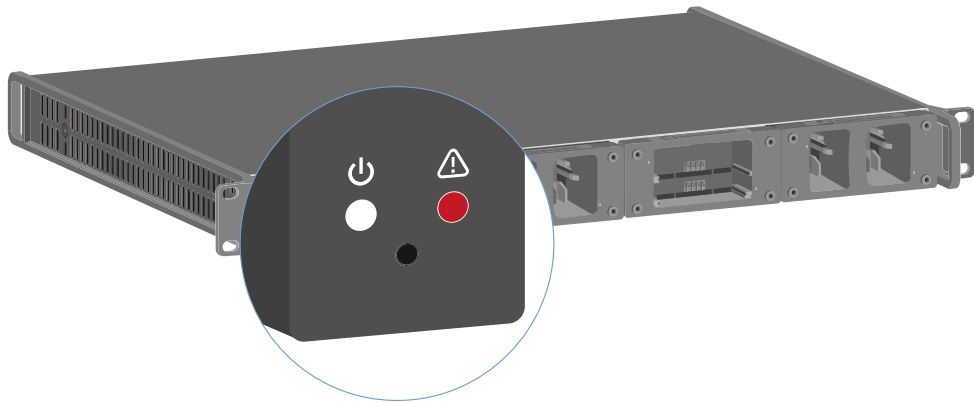

Meaning of the LEDs

You can read the following information from the LEDs on the L 6000 charger and the LM 6060, LM 6061, LM 6062 and LM 6070 charging modules:

L 6000 status LEDs

The L 6000 charger has two status LEDs on the front of the device to the left.



 	White LED flashing >> device is starting or firmware is being updated
 	White LED illuminated >> device is ready for operation
 	Red LED flashing >> fan is damaged
 	Red LED illuminated >> device is too hot or too cold and the charging process was stopped

LM 6060 | LM 6061 | LM 6062 | LM 6070 status LEDs

The LM 6060, LM 6061, LM 6062 and LM 6070 modules each have two charging slots. Next to each charging slot, there is a status LED that displays the following status information:



	Flashing red >> the charging slot or rechargeable battery is too hot or too cold and the charging process was stopped.
---	---



Lights up red >> the rechargeable battery is defective.



Flashing yellow >> the rechargeable battery is being regenerated.



Lights up yellow >> the rechargeable battery is being charged. Charge level **0% to 80%**



Flashing green >> the rechargeable battery is being charged. Charge level **81% to 96%**



Lights up green >> the rechargeable battery is fully charged. Charge level **100%**

LM 6060, LM 6061, LM 6062 and LM 6070 status LEDs in storage mode

If you are operating the L 6000 charger in **storage mode** via **WSM**, the meaning of the status indicators changes. You can find more information under [Preparing rechargeable batteries for storage \(storage mode\)](#).



Preparing rechargeable batteries for storage (storage mode)

If you are not using the rechargeable batteries for a longer period of time and therefore want to store them, the rechargeable batteries should have a charge of approx. 70%.

You can set this level using the **storage mode** from the Sennheiser Wireless Systems Manager (WSM) software.

- ▶ To do so, connect the L 6000 charger to a network (see [Connecting the L 6000 to a network](#)) and establish the connection with the WSM software.

i For more information about controlling devices via the **Sennheiser Wireless Systems Manager** (WSM) software, refer to the instruction manual for the software. You can download the software here: sennheiser.com/wsm

Meaning of the status LEDs in storage mode

In **storage mode**, the status LEDs next to the individual charging slots show the following status information:

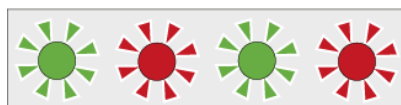

Flashing green/red >> rechargeable battery not inserted.



Flashing yellow/red >> the rechargeable battery is being charged or discharged to 70%.

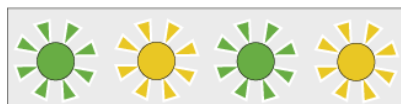

Flashing green/yellow >> the rechargeable battery has reached the storage charge level of 70%.



Resetting settings (factory reset)

To reset the L 6000 charger settings to the factory settings:

- ▶ Use a pointed object to press the Reset button on the front of the L 6000 charger.
- ✓ The settings are reset to the factory settings.

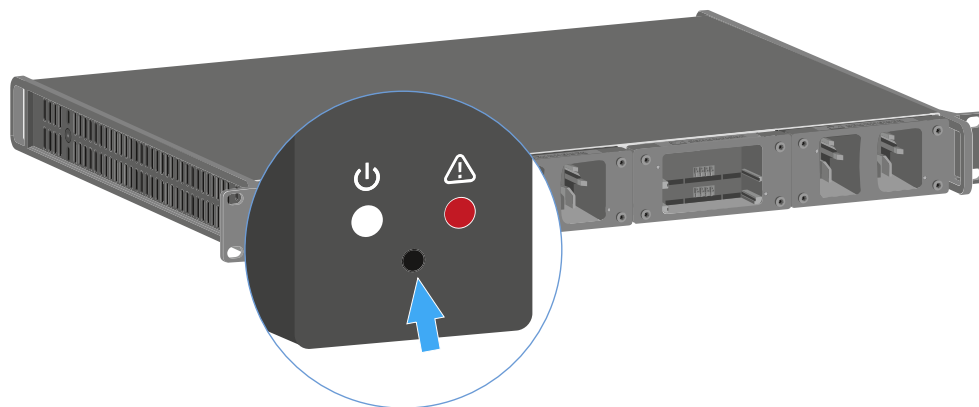



Updating the firmware

You can update the firmware for the L 6000 charger using the Sennheiser **Wireless Systems Manager** (WSM) software.

- ▶ To do so, connect the L 6000 charger to a network (see [Connecting the L 6000 to a network](#)) and establish the connection with the WSM software.

i For more information about controlling devices via the **Sennheiser Wireless Systems Manager** (WSM) software, refer to the instruction manual for the software. You can download the software here: sennheiser.com/wsm

i You can find the **latest firmware** on the Digital 6000 product page or in the Sennheiser website's download area: sennheiser.com/digital-6000
sennheiser.com/download



Operating the L 6000 via a network

You can use the Sennheiser **Wireless Systems Manager** software to operate the charger via a network connection.

- ▶ To do so, connect the L 6000 charger to a network (see [Connecting the L 6000 to a network](#)) and establish the connection with the WSM software.

i For more information about controlling devices via the **Sennheiser Wireless Systems Manager** (WSM) software, refer to the instruction manual for the software. You can download the software here: sennheiser.com/wsm

You can perform the following actions using WSM:

- Update the L 6000 charger firmware
- Prepare rechargeable batteries for storage (see [Preparing rechargeable batteries for storage \(storage mode\)](#)).



Cleaning and maintenance

Note the following information when cleaning and maintaining products of the Spectera series.

NOTICE



Liquids can damage the electronics of the product

Liquids entering the product housing can cause a short-circuit and damage the electronics.

- ▶ Keep all liquids away from the products.
- ▶ Do not use any solvents or cleansing agents.
- ▶ Disconnect the mains-operated products from the power supply system and remove rechargeable batteries and batteries (if present) before you begin cleaning.
- ▶ Clean all products only with a soft, dry cloth.

- ▶ Note the special cleaning instructions below for the following products.

Replacing the Base Stations fan filter

- ▶ Check the filter from time to time and replace it if necessary. See [Changing the fan filter](#).

Cleaning the L 70 USB and CHG 70N chargers

- ▶ Remove all rechargeable batteries from the charging slots.
- ▶ Disconnect the charger from the power supply system before cleaning.
- ▶ Clean the product with a dry cloth.
- ▶ In addition, use a brush to remove dust from the charging slots.
- ▶ Clean the charging contacts from time to time with a cotton swab, for instance.



5. Knowledge base

Central hub for information, resources, and guides with further content on the product and/or service.

Network guide

This network guide is intended for IT administrators, system integrators and event technicians and serves as an planning and configuration guide for integrating components of the Spectera offering into diverse network environments from small home networks up to enterprise networks.

The guide contains recommendations on network setup for transmission of control data and audio content (via Dante®).

Introduction

This network guide is intended for IT administrators, system integrators and event technicians and serves as an planning and configuration guide for integrating components of the Spectera offering into diverse network environments from small home networks up to enterprise networks.

The guide contains recommendations on network setup for transmission of control data and audio content (via Dante®).



General requirements

Operating systems

The Spectera Base Station as network device is able to be controlled by network-capable PC or Mac devices.

The following system requirements apply for operation with Spectera WebUI and Sennheiser LinkDesk:

System requirements

- Intel i5 Dual Core processor/M1 Mac/or similar
- 16 GB RAM
- At least 4 GB hard disk space (5 GB for Mac devices)
- Gigabit LAN interface
- Windows® 10, 11, Server 2019, Server 2022 (x64) or higher
- Mac OS Big Sonoma or later
- IPv4 network

Supported web browsers for Spectera WebUI

- Google Chrome: 125 or later
- Microsoft Edge: 125 or later
- Mozilla Firefox: 128 or later
- Apple Safari: 17 or later
- JavaScript must be activated



Network

Bandwidth and speed

When it comes to bandwidth requirements for high-quality audio, there are a number of factors that can affect the input and output of the audio. The network speed required for especially audio transmission via Dante® should be as high as possible to ensure a smooth listening experience. As a rule, the minimum bandwidth for transmitting and receiving audio at the Spectera Base Station is approximately the following:

The majority of audio used in professional settings is PCM (uncompressed), sampled at 48 kHz and a bit depth (word length) of 24 bits. Dante® audio is unicast by default but can be set to use multicast for cases of one-to-many distribution.

- Dante® packages audio into flows to save on network overhead.
- Unicast Audio flows contain up to 4 channels. The samples-per-channel can vary between 4 and 64, depending on the latency setting of the device. Bandwidth usage is about 6 Mbps per typical unicast audio flow.
- Bandwidth for multicast flows is dependent on the number of audio channels used. Bandwidth is about 1.5 Mbps per channel.

Source: [Audinate Dante Information for Network Administrators \(PDF\)](#)

Internet access

For both components Spectera Base Station and Sennheiser LinkDesk we recommend to provide permanent Internet access. Please refer to chapter [Ports, protocols and services](#) to get more details about used Internet services.

i At least for the initial product activation of the Spectera Base Station and for the use of the optional Sennheiser Account Login in Sennheiser LinkDesk it is mandatory to have a direct Internet access and DNS support.

i At the moment it is not possible to manually configure any network proxy and DNS server at Spectera Base Station. Please make sure to provide direct Internet access e.g. via white-listing the device and any used port, protocol and domain and using DHCP to provide DNS server settings.



Network infrastructure (switches/cables)

Generally any kind of unmanaged or managed network switch can be used for control and audio data transmission. For proper operation of Dante® some fundamental requirements need to be fulfilled:

- When using managed switches, ensure that they allow EEE (Energy Efficient Ethernet or "Green Ethernet") to be disabled. Make sure that EEE is disabled on all ports used for real-time Dante traffic.
- When using unmanaged switches, do not use switches that support the EEE function, because it cannot be disabled.
- Make sure that the switch supports Quality of Service (QoS) and that it is enabled.
- For larger networks, consider using VLANs to segment audio traffic from other types of network traffic.

i For further information about that topic, please refer to the: [Audinate FAQ - Networks and Switches](#). Additionally, there is a list of incompatible switches available at Audinate: [Audinate List of incompatible EEE switches \(PDF\)](#)

To ensure a reliable transmission speed of audio and control data with the Spectera Base Station, please use an RJ45 network cable with the CAT5e S/FTP standard or higher.



Network setups

To operate the several components of the Spectera offering they need to be integrated into a network setup, either existing or new. Following figure shows a general overview of the network setup and their participants.

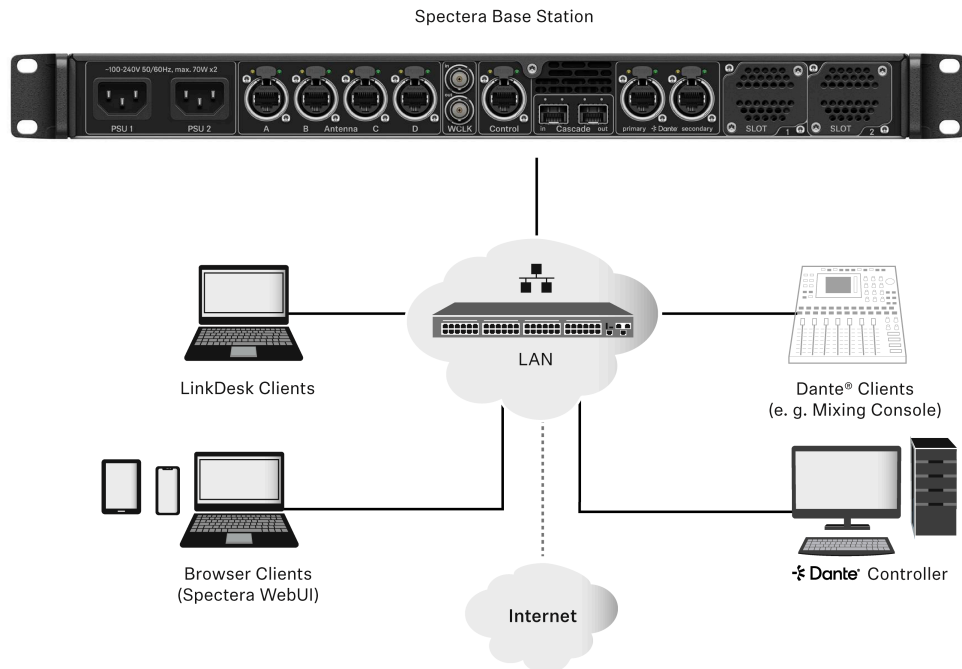

Spectera Base Station

This Sennheiser device has 3 network interfaces. One interface dedicated for control data and two interfaces for audio data (specifically Dante®). There is a primary and a secondary interface for redundancy of the audio transmission.

Sennheiser LinkDesk client

This client can be any host computer (PC or Mac), with the LinkDesk software application installed.

Browser Client (Spectera WebUI)

This client can be any host computer (PC, Mac, Tablet, Smartphone), with a supported web browser installed, accessing the Spectera WebUI.

Dante® client

This can be any device with a Dante® network interface installed. This ranges from Virtual Dante® Soundcards installed on a host computer up to dedicated devices like a Mixing Console.



Dante® Controller

This is typically host computer (PC or Mac), with the Dante® Controller software application installed. This application configures and controls all the Dante® devices and audio streams inside the network.

LAN with network switches and router

This can be any network switch for routing the network communication inside the Local Area Network (LAN) and any network router providing the gateway to other networks and to the Internet.

Spectera Base Station - network configuration

Depending on the desired network address configuration all network interface (Control and both Dante®) can be operated in following IP Modes with IPv4 only:

- Fixed/Static IP
- Auto IP (DHCP or Zeroconf)

Additionally it can be configured if mDNS/DNS-SD information shall be published by the device or not.

i Dante® restrictions

- It is not possible to deactivate the Dante® functionality for the both Dante® ports.
- Dante® ports are shutdown when the device is in standby mode.
- Network configuration of Dante® ports can only be done via Dante® Controller software application.
- By default the Dante® ports are configured to Auto IP. If Fixed/Static IPs have been configured and the device cannot be reached anymore, the IP Mode can only be reset to Auto IP by a Factory Reset of the device.
- The Dante primary and secondary networks must not be directly connected to each other (network loop). Make sure you always connect the Base Station Dante network ports to two different networks that do not run via a common switch.

Shared Network Mode

In Shared Network Mode both networks for Control and Dante® are using the same physical network infrastructure.

- Configure both Control and Dante® networks over one switch / router.
- Use two different IPs to address the Control network and the Dante® network separately.



i The Spectera Base Station can not be configured to use VLAN tagging (IEEE 802.1Q) at its network ports. Still it is possible to use network switches that support VLANs to separate the Control and Dante® traffic within the same physical network. Please make sure that the switch is configured to forward untagged traffic from both networks to the respective ports of the Base Station. Additionally, make sure that the switch is configured to forward multicast traffic for the Dante® network.

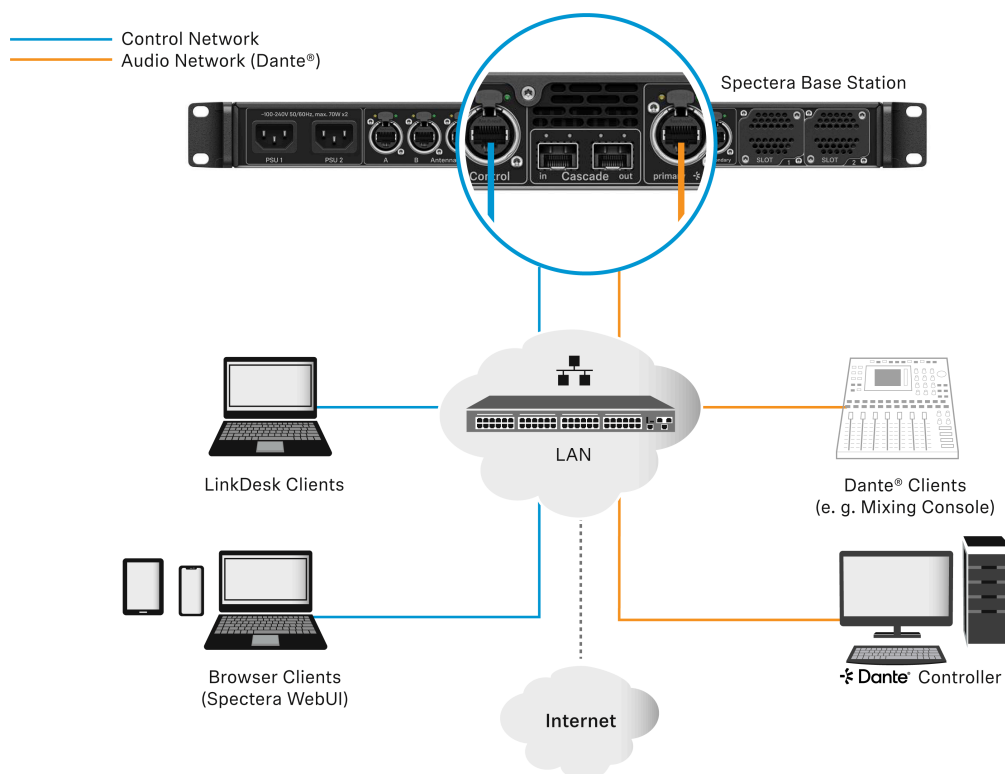

Split Network Mode

In Split Network Mode both networks for Control and Dante® are using different physical network infrastructure.

- Configure both Control and Dante® networks over two different switches / routers.
- Use two different IPs to address the Control network and the Dante® network separately.

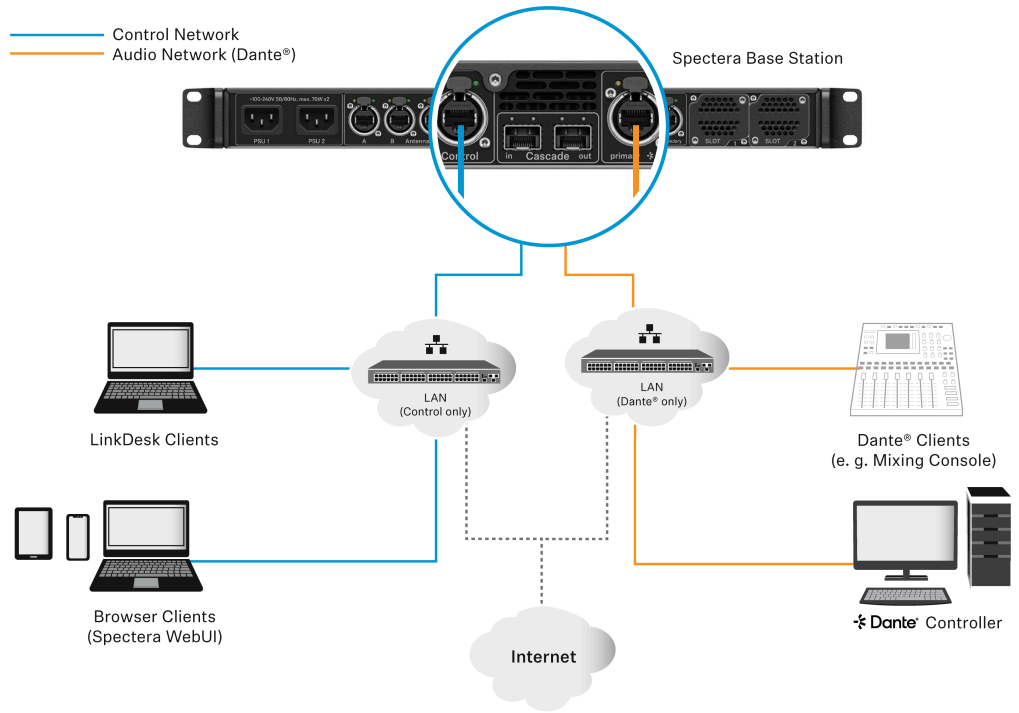



Ports, protocols and services

Spectera Base Station

In order to use the Spectera Base Station device in a network, certain ports must be enabled (especially for the organization/enterprise firewall) for communication between software and devices.

i If necessary, please contact the local administrator to configure the required ports.

Ports - Base Station Control Network Interface

Address	Port	Protocol	Type	Service	Usage
Requests from device to ...					
Sennheiser License Server address ¹	80	HTTPS (TCP)	Unicast	Sennheiser License Server	Activation of devices
ANY address of time server (see list of NTP time server pools)	123	NTP	Unicast	NTP Time Server	Synchronize system time
224.0.0.251	5353	mDNS (UDP)	Multicast	mDNS, DNS-SD	(optional - if desired) Device/Service Discovery
Requests to device from ...					
ANY IP of SSCv2 client	443	HTTPS (TCP)	Unicast	SSCv2 - Spectera Base Station API	Monitor+Control communication from clients
¹ my.nalpeiron.com					

NTP servers

To correctly operate with licenses and certificates, the Spectera Base Station needs a correct system time. The device will use the well-established NTP mechanism from the IP protocol stack to synchronize clock between a time server in a network and the client inside the device.

Currently for an IT administrator or system integrator it is not possible to manually configure a dedicated NTP server to be used by the Spectera Base Station. Being able to configure a dedicated NTP server manually is a planned feature for an upcoming release.



The device behaves the following way:

- If a time server configuration has been provided via DHCP or manually, it tries to connect and sync to that time server first.
- Otherwise the device is trying to access any server of following list of time server pools worldwide publicly available.

i An IT administrator has to assure to provide Internet access to at least one of the server pools and to provide DNS settings via DHCP to the device.

List of NTP time server pools:

- pool.ntp.org
- time.nist.gov
- time.aws.com
- time.cloudflare.com

Ports - Base Station Dante® Network Interfaces

Spectera Base Station requires several ports to be opened for both Dante® Network Interfaces to operate properly. For the list of ports and more detailed information, please refer directly to the Dante® website: [Audinate FAQ - Networks and Switches](#).



Spectera WebUI

In order to use the Spectera WebUI, certain ports must be enabled (especially for the organization/enterprise firewall) for communication between software and devices.

i If necessary, please contact the local administrator to configure the required ports.

Port requirements

Address	Port	Protocol	Type	Service	Usage
Requests from host to ...					
ANY IP of a Base Station	443	HTTPS (TCP)	Unicast	SSCv2 - Spectera Base Station API	Monitor+Control communication to devices
Sennheiser User Insights addresses ¹	443	HTTPS (TCP)	Unicast	Sennheiser User Insights	Analytics of usage and operational data
¹ sennheiseruserinsights.matomo.cloud cdn.matomo.cloud					



Sennheiser LinkDesk

In order to use the Sennheiser LinkDesk software, certain ports must be enabled (especially for the organization/enterprise firewall) for communication between software and devices.

i If necessary, please contact the local administrator to configure the required ports.

Port requirements

Address	Port	Protocol	Type	Service	Usage
Host Internal					
LOCALHOST	54352	HTTPS (TCP)	Unicast	LinkDesk backend	Internal backend communication
Requests from host to ...					
ANY IP of a Base Station	443	HTTPS (TCP)	Unicast	SSCv2 - Spectera Base Station API	Monitor+Control communication to devices
Sennheiser CIAM addresses ¹	443	HTTPS (TCP)	Unicast	Sennheiser CIAM	Sennheiser account Sign-in/Log-in
Sennheiser User Insights addresses ²	443	HTTPS (TCP)	Unicast	Sennheiser User Insights	Analytics of usage and operational data
Requests to host from ...					
224.0.0.251	5353	mDNS (UDP)	Multicast	mDNS, DNS-SD	(optional - if desired) Device/service discovery

¹ accounts-pro-emea.sennheiser-cloud.com

b2c-config.sennheisercloud.com

² sennheiseruserinsights.matomo.cloud

cdn.matomo.cloud



Best practice

Sharing Internet connection in small network setups

It is possible to operate the Spectera offering without dedicated router networks e.g. in really small setups, but we do recommend to always use some kind of home network router for trouble-free usage.

Especially for providing Internet access to Spectera Base Station it is possible to use the builtin functionality of Windows and MacOS for Internet Connection Sharing.

i For enterprise networks we DO NOT RECOMMEND the usage of Internet Connection Sharing. Most of the times it is even prohibited by enterprise IT policy to use such service.

The network setup might look like this:

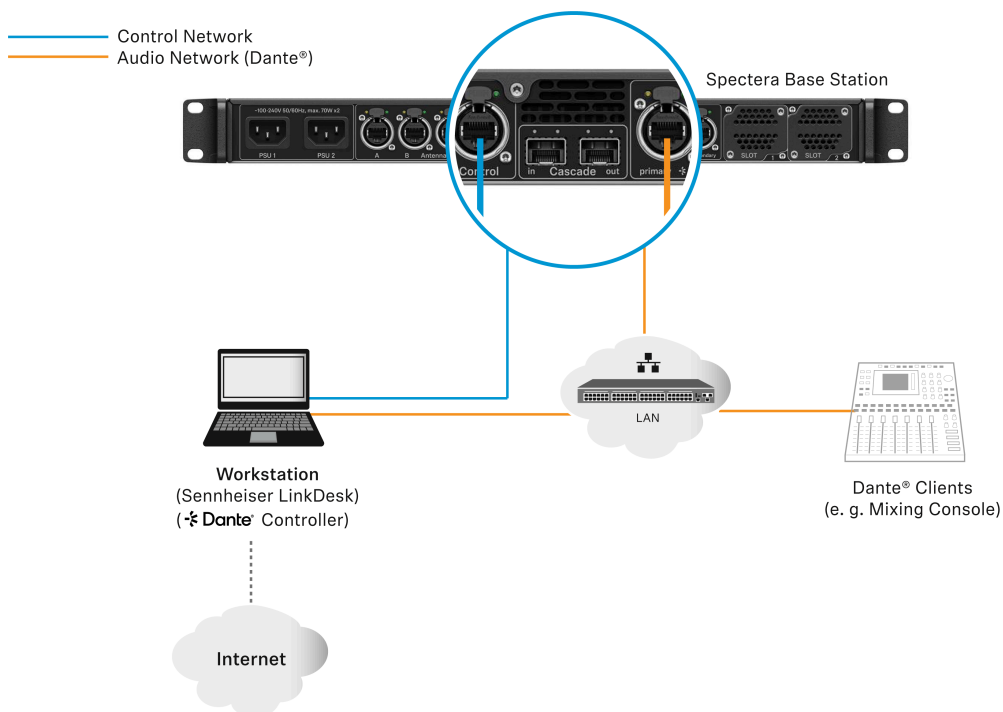

Inside this setup one workstation is used for all client software applications (Sennheiser LinkDesk, Spectera WebUI, Dante® Controller). Either two separated wired network interface are used for control and audio (Dante®) or one interface gets shared. Please be aware that in such setups (typically) no DHCP service is activated. Use either manual IP settings or ZeroConf configuration.

For Internet Connection Sharing typically an existing network connection (Wi-Fi or Ethernet) with Internet access gets shared with another selected network interface of the host.



In order to share your Internet connection on Windows:

- ▶ Connect your client device to your host PC using an Ethernet cable. If either device doesn't have a free Ethernet port, use a USB-to-Ethernet adapter.
- ▶ Go to the **Network Connections** menu. The easiest way to get there is by searching for "Network Connections" in the Windows Search box.
- ▶ Right-click on the network adapter connected to the Internet (for example, Wi-Fi or modem), and then select **Properties**.
- ▶ Toggle **Allow other network users to connect** to **ON** from the Sharing tab and select the relevant Ethernet port from the pull-down menu.

i Note that, if you have VPN software installed, you may see a lot of virtual Ethernet ports on your list and you'll need to pick the real one.

- ✓ After you click OK, Internet should flow to your client device over its Ethernet port. For more details on sharing an Internet connection please refer to the [Microsoft Support](#) page.

In order to share your Internet connection on MacOS:

- ▶ On your Mac, choose **Apple menu > System Settings**.
- ▶ Click on **General** in the sidebar and then on **Sharing** (you may need to scroll down).
- ▶ Turn on **Internet Sharing** and click on **Configure**.
- ▶ Click the **Share your connection** from pop-up menu.
- ▶ Choose the Internet connection you want to share ((For example, if you're connected to the Internet over Wi-Fi, choose Wi-Fi).
- ▶ Under **To devices using**, turn on the port other devices can use to access the shared internet connection. (For example, if you want to share your Internet connection over Ethernet, select Ethernet).

i If you're sharing to devices using Wi-Fi, configure the Internet-sharing network, then click **OK**.

- ▶ Click on **Done**.

i For more details on sharing an Internet connection please refer to the [Apple Support](#) page.



✓ Your Internet connection will be shared on MacOS/Windows.



Security guide

This security guide provides essential information and best practices for IT administrators, system integrators, and event technicians to ensure robust security measures are implemented effectively.

Professional audio systems, extensively deployed in environments such as broadcasting, live events, and corporate settings, are increasingly integrated into enterprise networks — making them susceptible to threats like unauthorized access, data interception, and signal interference. To ensure secure deployment and system integrity, Sennheiser enforces the highest security standards across all products, supported by robust protective measures and comprehensive management practices.

- **Security Principles and System Design:**

Sennheiser embeds security from product development through regular risk assessments and secure configurations, following a “security by design” approach. Compliance with international standards ensures consistent protection and proactive threat mitigation.

- **Communication Security and Encryption:**

Industry-standard encryption protocols like AES-256 and TLS protect audio and control data from interception and unauthorized access. Secure methods such as HTTPS and REST APIs are used for networked and third-party integrations.

- **Authentication and Access Control:**

Role-based authentication and device claiming validate users and devices before granting access. Credentials and regular updates maintain system integrity and prevent unauthorized access.

- **Network Configuration and Interfaces:**

Enable only essential ports, segment networks, and apply firewall rules for secure operation. Proper configuration of protocols like Dante®, mDNS, and Bluetooth® is critical for a robust network infrastructure.

This guide provides comprehensive measures to protect professional audio systems from threats through secure design, encryption, authentication, and best practices throughout the system lifecycle.

Introduction

This security guide provides essential information and best practices for IT administrators, system integrators, and event technicians to ensure robust security measures are implemented effectively.

Professional audio systems, extensively deployed in environments such as broadcasting, live events, and corporate settings, are increasingly integrated into enterprise networks — making them susceptible to threats like unauthorized access, data interception, and signal interference. To ensure secure deployment and system integrity, Sennheiser enforces the



highest security standards across all products, supported by robust protective measures and comprehensive management practices.

- **Security Principles and System Design:**

Sennheiser embeds security from product development through regular risk assessments and secure configurations, following a “security by design” approach. Compliance with international standards ensures consistent protection and proactive threat mitigation.

- **Communication Security and Encryption:**

Industry-standard encryption protocols like AES-256 and TLS protect audio and control data from interception and unauthorized access. Secure methods such as HTTPS and REST APIs are used for networked and third-party integrations.

- **Authentication and Access Control:**

Role-based authentication and device claiming validate users and devices before granting access. b credentials and regular updates maintain system integrity and prevent unauthorized access.

- **Network Configuration and Interfaces:**

Enable only essential ports, segment networks, and apply firewall rules for secure operation. Proper configuration of protocols like Dante®, mDNS, and Bluetooth® is critical for a robust network infrastructure.

This guide provides comprehensive measures to protect professional audio systems from threats through secure design, encryption, authentication, and best practices throughout the system lifecycle.



Key product security features

Key security features of Spectera devices and software tools are detailed, emphasizing best practices for IT administrators to ensure secure communication and data protection.

Spectera devices (Base Station, DAD, and Mobile Devices (SEK)) and software tools such as **Spectera Base Station WebUI** and **Sennheiser LinkDesk** support enhanced security measures, ensuring both a secure connection between devices via radio and secure data transfer over the network. It offers the following security features:

- **AES-256 Link Encryption:**

The AES-256 Link Encryption protects audio and control communication between devices.

- **Control Protocol Encryption:**

The WebUI is always using encrypted HTTPS communication. The SSCv2 protocol secures the communication between devices and software tools via HTTPS.

- **Device Claiming & Authentication:**

The Device Claiming & Authentication feature ensures authorized control access using passwords.

- **Dante® Media Encryption:**

The Dante® Media Encryption is an optional channel encryption for Dante networks

AES-256 Link Encryption

All wireless communication between the Spectera devices will be protected with AES-256, a top-tier encryption standard designed to safeguard sensitive data.

Link Encryption includes the following interfaces:

- The connection between the Base Station and Mobile Devices for audio transmission.
- The connection between the Base Station and Mobile Devices for device setting synchronization.

i The AES-256 Link Encryption is always enabled and can not be disabled.



Control Protocol Encryption

All control communication over the network to the Base Station is encrypted and authenticated.

It offers end-to-end security, utilizing HTTPS (TLS 1.3). Communication to the Sennheiser license server is encrypted on application level.

The Protocol Encryption is always enabled and can not be disabled.



Device Claiming & Authentication

Device claiming and authentication enhance security by requiring password protection for device access and ensuring only authorized users can modify settings through encrypted connections.

The device access via network control API and WebUI of Spectera Base Station and via Sennheiser LinkDesk is password protected, to avoid configuring the device by unauthorized actors inside the network.

The Device Authentication is always enabled and can not be disabled.

Benefits of device claiming

- **Device Claiming Feature:**

Device claiming is a feature of the Sennheiser LinkDesk and Spectera Base Station WebUI that allows the user to claim ownership of their Sennheiser devices, providing an extra layer of security and control.

- **Device Assignment:**

It allows assigning a device to one or more remote installations, which prevents any unauthenticated device control within the network.

- **Initial Configuration:**

As part of the initial configuration, users claim a device by configuring a mandatory device password.

- **Usability:**

Within an installation, multiple software applications can be used simultaneously with this device password for optimal usability

- **Security Measures:**

Once a device is claimed, its settings can only be viewed and modified via an encrypted connection, which requires entry of the configuration password.



Dante® Media Encryption (available as of Spectera Dante® firmware Brooklyn3 version 1.1.0)

Dante® Media Encryption extends the security benefits of using Dante® on your network by concealing the media content during transmission between devices.

Dante® utilizes the Advanced Encryption Standard (AES) with a 256-bit key to provide industry-leading media protection.

Concealing the contents of media packets prevents malicious or unauthorized users eavesdropping or interfering with Dante media traffic.

i By default, Dante Media Encryption is disabled, since encryption can only be configured by using the Dante Director application. Please refer to the Audinate documentation for detailed information on Dante® encryption, on how to enable and configure encryption and to update the Dante® firmware:

- Dante Media Encryption: [Audinate/Media Encryption](#)
- Updating Dante® firmware: [Dante Updater](#)



How to use the security features

The following section explains how you can use the various security features both via the device itself and via supported software applications.

Certificates

Spectera Base Station is using a self-signed certificate for network communication.

The certificate is generated in factory and will be renewed with every factory reset.

i Currently it is not possible to replace the certificate with a CA-signed certificate.

When accessing the Spectera WebUI with a browser for the first time you will get a security warning informing about an unknown certificate. The security warning depends on the browser you are using. Depending on your browser, click on Advanced or Show Details (Safari) and then on:

- Microsoft Edge: **Continue to localhost (unsafe)**
- Google Chrome: **Proceed to localhost (unsafe)**
- Firefox: **Accept the Risk and Continue**
- Apple Safari: **[...] visit this Website > Visit Website**
- or similar (other browsers)

In order to prevent man-in-the-middle (MITM) attacks, Sennheiser LinkDesk has some built-in security measures. Because of these measures, you might receive a certificate mismatch warning while working with a Base Station. In some cases, these can occur even though there is actually no security issue. These are:

- The Base Station has been factory reset since the last connect. In this case you can safely confirm the connection and proceed when encountering the mismatch warning.
- A different Base Station has been connected via the same IP address. In this case please verify if the IP Address you are using is indeed the correct IP Address of the intended Base Station.



Device authentication

The devices access via network is password protected and the device must be claimed in the control software before use.

You can claim the Base Station via:

- LinkDesk (see [Claiming single device \(LinkDesk\)](#)) or
- WebUI (see [Claiming single device \(WebUI\)](#)).

i Please note that the new password must meet the following requirements:



- At least ten characters
- At least one lowercase letter
- At least one uppercase letter
- At least one number
- At least one special character: !#\$%&()*+,-./:;<=>@[!^_{}~
- Maximum length: 64 characters



Claiming single device (LinkDesk)

Instructions for claiming a single device in Sennheiser LinkDesk.

To claim your Base Station:

- ▶ In your production card, activate the function  **DEVICE SYNCHRONIZATION** on the left-hand side of the top bar.
- ▶ Click on the  symbol in the **BASE STATIONS** bar on the right.
- ▶ Enter the correct IP address of the Base Station and click on **Search**.
 - If the device is in a factory default state and the original password is still assigned, it will be automatically detected and applied. Next, a new password has to be set:

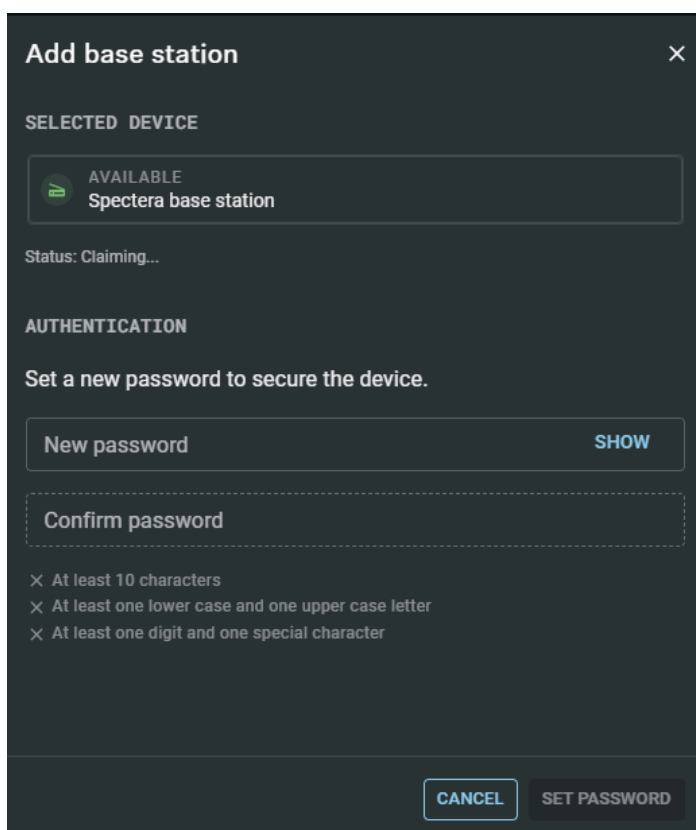

Add base station ×

SELECTED DEVICE

 AVAILABLE
Spectera base station

Status: Claiming...

AUTHENTICATION

Set a new password to secure the device.

New password SHOW

Confirm password

× At least 10 characters
× At least one lower case and one upper case letter
× At least one digit and one special character

CANCEL SET PASSWORD

- If the device was previously claimed by another Sennheiser LinkDesk or Spectera WebUI instance, the previously set password must be entered:



i If you cannot remember the previously set password, please perform a factory reset of the device. After the reset, the default password for Spectera will be automatically applied by the software.

- ▶ Set a new device password (if you are logging in for the first time) or enter the password you have already assigned for authentication (if you have already logged in).

i Please note that the new password must meet the following requirements:

- At least ten characters
- At least one lowercase letter
- At least one uppercase letter
- At least one number
- At least one special character: !#\$%&()*+,-./:;<=>?@[^_{}~
- Maximum length: 64 characters

✓ Your Base Station has been claimed successfully.



Claiming single device (WebUI)

Instructions for claiming a single device in Spectera WebUI.

To claim your Base Station:

- ▶ Enter the following URL into your browser: `https://deviceIP/specterawebui/index.html`.

i Since the certificate is unknown to your browser, a security warning is displayed the first time you run the application. The security warning depends on the browser you are using.

- ▶ Depending on your browser, click on **Advanced** and then on:
 - **Continue to localhost (unsafe)** (Microsoft Edge)
 - **Proceed to localhost (unsafe)** (Google Chrome)
 - **Accept the Risk and Continue** (Firefox)
 - or similar (other browsers).
- ✓ The WebUI displays the following options depending on the state of the device:
 - If the device is in a factory default state and the original password is still assigned, it will be automatically detected and applied. Next, a new password has to be set:

The screenshot shows a dark-themed web interface titled "Claiming an initial factory reset device". Below the title is "Welcome to Spectera Base Station". There are two input fields: "Password" and "Re-enter Password". Below these fields, red text specifies the password rules: "Password rules: 10-64 characters, at least one capital letter, one lower letter, one numeral and one special character". At the bottom, there is a "Submit" button and a checkbox for "EULA". A small copyright notice at the very bottom states: "© We collect operational data to continually improve the stability and functionality of Spectera. We pseudonymize the data so that there is no direct personal reference. You can prevent tracking in the settings."

If the device was previously claimed by another Sennheiser LinkDesk or Spectera WebUI instance, the previously set password must be entered:

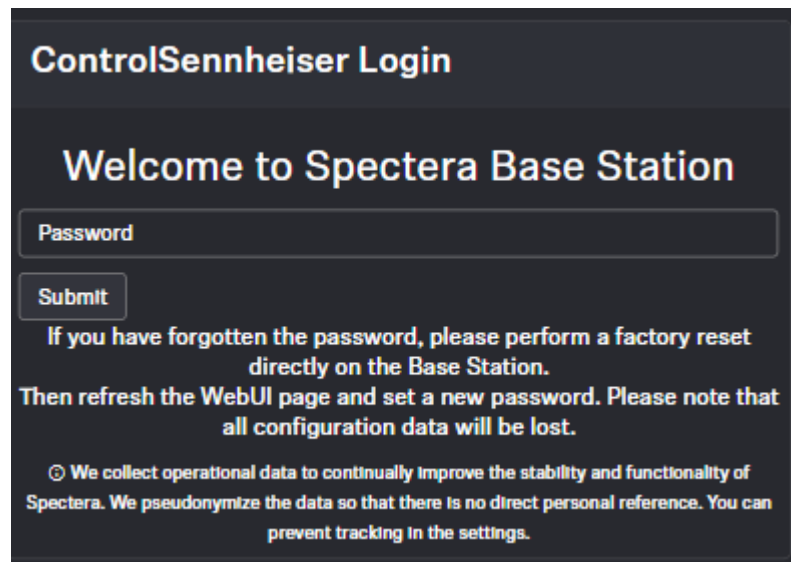

i If you cannot remember the previously set password, please perform a factory reset of the device. After the reset, the default password for Spectera will be automatically applied by the software.

- ▶ Set a new device password (if you are logging in for the first time) or enter the password you have already assigned for authentication (if you have already logged in).
- ▶ Click on **Submit**.

✓ Your Base Station has been claimed successfully.



Resetting the device password (Spectera Base Station)

The device password can only be reset through a factory reset (either performed directly on the device or remotely via WebUI):

To reset the Base Station remotely:

- ▶ In the top bar, navigate to **Configuration > Base Station**.
- ▶ Click on **Settings** and then on **Factory Reset**.
- ✓ A countdown timer will be displayed (highlighted in blue).

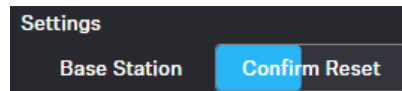

- ▶ Press **Confirm Reset** to confirm the factory reset.

To reset the Base Station to its factory default settings using the device:

- ▶ On the Base Station, rotate the jog-dial and navigate to the menu **Reset**.
- ▶ Press the jog-dial to enter the menu.
- ✓ A warning will appear.

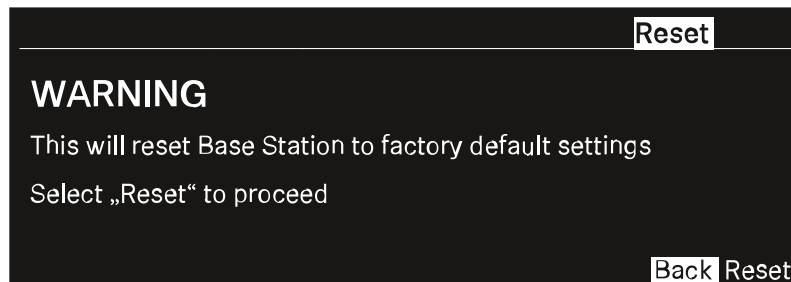

- ▶ Rotate the jog-dial to **Reset**.
- ▶ Press the jog-dial again.
- ✓ The Base Station will be set back to factory settings and reboot.

i After rebooting, check the IP address as it may have changed.



Troubleshooting

This chapter provides a systematic approach for identifying and resolving issues that may occur during the startup or operation of Spectera.

Depending on the specific problem, click on the relevant chapter to identify possible causes and apply potential solutions.

License activation fails

Condition

An error occurs during license activation.

Causes

The three most common causes of activation errors are as follows:

1. The Base Station was not connected properly and has no Internet connection (see [Solution 1: Establish a proper connection of the Base Station to the Internet](#)).
2. The license server and/or NTP time server are/is unreachable due to missing port permissions, preventing license key authorization and system clock synchronization (see [Solution 2: Open required ports for license activation and system clock synchronization](#)).
3. The license key was entered incorrectly or has already been activated and is in use with another Base Station (see [Solution 3: Check the activation code and contact support if necessary](#)).

Solution 1: Establish a proper connection of the Base Station to the Internet

- ▶ Please connect the Base Station directly to a network with Internet access via a switch or router.

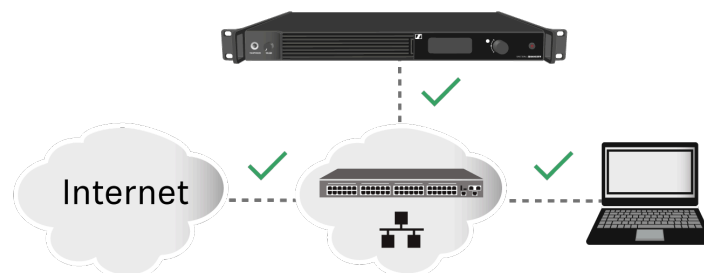



- ▶ Direct connections via laptop etc. are only supported in certain network configuration (see [Sharing Internet connection in small network setups](#)). To eliminate this issue, please avoid a direct connection with your device for license activation.

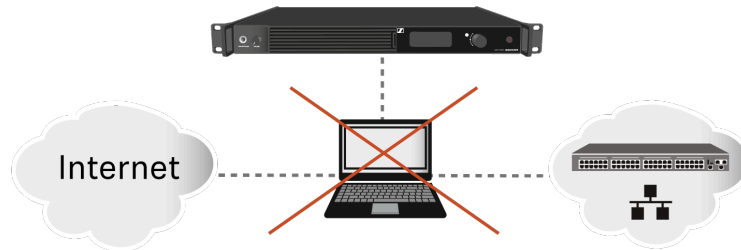

Solution 2: Open required ports for license activation and system clock synchronization

- ▶ Please contact your IT administrator to provide Internet access to the License Server and any NTP server by opening the required network ports and to provide DNS settings via DHCP to the device.

Address	Port	Protocol	Type	Service	Usage
my.nalpeiron.com	80	HTTPS (TCP)	Unicast	Sennheiser License Server	Activation of devices
ANY (see list of NTP servers)	123	NTP	Unicast	NTP Time Server	Synchronize system time

i You can find the complete overview of all ports at [Ports, protocols and services](#).

Solution 3: Check the activation code and contact support if necessary

- ▶ Please verify that you have correctly entered the Activation Code, or check if someone else has already used the code to activate another Base Station.
- ▶ If the code has already been used for activation, please reach out to Sennheiser Customer Support.



No device access via the WebUI

Condition

The device cannot be accessed via the self-hosted WebUI.

Cause

The wrong device IP or URL schema is being used in the browser.

Solution

- ▶ Find out the correct IP of the Base Station (see [Network](#)).
- ▶ Enter the correct IP using the correct URL schema depending on the initial firmware version:
 - Firmware \leq 0.8.x use `https://deviceIP/specteracontrol/index.html` .
 - Firmware \geq 1.x.x use `https://deviceIP/` .
- ✔ In some cases the internet browser might have trouble showing the page.



The Base Station cannot be found

Condition

The Base Station cannot be found via WebUI / Dante Manager.

Cause

The required ports for communication with the Base Station have not been made accessible.

Solution

- ▶ Depending on the use case, please make the necessary ports available for the Base Station, so that data traffic can flow unrestricted:
 - [Spectera Base Station](#)
 - Dante®



Interference noise with old RF devices

Condition

Other devices are disturbed or produce audible interference noise.

Cause

Old devices do not have good RF shielding.

Solution

- ▶ Increase the distance between the devices.



Noise in the audio signal

Condition

Noise may occur in the audio signal of the SEK at the MIC/Line input.

Cause

Insufficient shielding of microphones or instrument cables.

Solution

- ▶ Use microphones or instrument cables with sufficient shielding.



6. Specifications

All technical data, system requirements and frequencies at a glance.

Spectera System

Transmission scheme

- Multicarrier, TDMA, TDD

RF channel

- Bandwidth: 6 or 8 MHz countrywise limited
- Mobiles devices: up to 128 per RF channel
- Audio links: up to 128 per RF channel

Radio frequency range

- UHF: 470 - 608 MHz, 630 - 698 MHz
- 1G4: 1350 - 1400 MHz, 1435 - 1525 MHz
- countrywise limited

Audio frequency response

- 20 Hz to 20,000 Hz (± 1 dB) (Audio link modes with SeDAC and PCM audio codecs only)

Encryption

- AES 256 CTR Mode exp. >10k years

Audio link modes

MIC/LINE	Mono	Max links per RF carrier	Utilized % of RF carrier	Audio codec	La-tency	Range
Raw Low Latency	Mono	8	12.5 %	PCM	1.0 ms	Reduced
Raw	Mono	16	6.25 %	PCM	1.6 ms	Reduced
Live Low Latency	Mono	8	12.5 %	SeDAC	1.0 ms	Extended
Live	Mono	16	6.25 %	SeDAC	1.6 ms	Extended
Live Link Density	Mono	32	3.13 %	SeDAC	2.7 ms	Standard



MIC/LINE	Mono	Max links per RF carrier	Utilized % of RF carrier	Audio codec	La-tency	Range
Max Range	Mono	16	6.25 %	OPUS	9.9 ms	Maximum
Max Link Density	Mono	128*	0.78 %	OPUS	15.2 ms	Reduced

IEM/IFB	Mono/ Stereo	Max links per RF carrier	Utilized % of RF carrier	Audio codec	La-tency	Range
Live	Mono	16	6.25 %	SeDAC	1.6 ms	Extended
Live Link Density	Mono	32	3.13 %	SeDAC	2.7 ms	Standard
Max Range	Mono	16	6.25 %	OPUS	9.9 ms	Maximum
Max Link density	Mono	128*	0.78 %	OPUS	15.2 ms	Reduced
Live Ultra Low Latency	Stereo	4 (8 ch)	25 %	SeDAC	0.7 ms	Extended
Live Low Latency	Stereo	8 (16 ch)	12.5 %	SeDAC	1.1 ms	Extended
Live	Stereo	16 (32 ch)	6.25 %	SeDAC	1.6 ms	Standard
Live Link Density	Stereo	32 (64 ch)**	3.13 %	SeDAC	2.7 ms	Reduced

* Base Stations have 32 audio outputs, for 128 links in a single RF channel, 4 Base Stations and firmware update with cascade port function are required (future release)

** Base Stations have 32 audio inputs, for 32 stereo links (64 ch) in a single RF channel, 2 Base Stations and firmware update with cascade port function are required (future release)



Base Station

General

RF channels

- 2

Audio inputs and outputs

- Input: up to 32 channels
- Output: up to 32 channels
- Individually selectable from digital audio interfaces

Digital audio inputs and outputs

- Dante®
 - Ethernet, 1 Gbit/s
 - 2× ruggedized RJ45 (Primary and Secondary)
 - 32 In, 32 Out, 48 kHz or 96 kHz, 16/24/32 bit
- MADI (AES10)
 - 2× Expansion Slots for MADI Card OM (optical fiber multimode) or MADI Card BNC (separate accessories)
 - 32 In, 32 Out, 48 kHz or 96 kHz, 16/24 bit
- Individual sample rate for each interface

Headphone output

- 6.3 mm jack
- 2x 50 mW at 32 Ω -40 dB THD (1%) at 1 kHz

Antenna connections

- 4 × ruggedized RJ45, PoE supply for up to 4 DAD UHF/1G4

Antenna cable

- Category 5e or higher, S/UTP (maximum 100 m)

Word clock input

- Input: BNC, 75 Ω
- Output: BNC, 75 Ω
- Sampling rates: 48 kHz, 96 kHz

Control

- Ethernet, 1 Gbit/s, ruggedized RJ45



Cascade in / out*

- 2 × SFP+ cages (to be equipped with 10 Gbit/s modules)

Power supply

- 2 x internal redundant
- 100 to 240 V AC, 50/60 Hz

Power consumption

- 70 W

Power plug

- 3-pin, protection class I as per IEC/EN 60320-1

Dimensions (H × W × D with mounting elements)

- 44 × 483 × 373 mm (1.73" x 19.02" x 14.69")

Weight

- Approx. 6.3 kg (13.89 lbs) (without accessories)

Temperature

- Operation: -10 °C to +50 °C (14 °F to 122 °F)
- Storage: -25 °C to +70 °C -13 °F to 158 °F)

Relative air humidity

- 25 % to 95 % (non-condensing)

Dripping and splashing liquids

- The product must not be exposed to dripping and splashing liquids (IP2X)

*Software update with cascade port function required (future release)

Ports - Base Station Control Network Interface

Address	Port	Protocol	Type	Service	Usage
Requests from device to ...					
Sennheiser License Server address ¹	80	HTTPS (TCP)	Unicast	Sennheiser License Server	Activation of devices



Address	Port	Protocol	Type	Service	Usage
ANY address of time server (see list of NTP time server pools)	123	NTP	Unicast	NTP Time Server	Synchronize system time
224.0.0.251	5353	mDNS (UDP)	Multicast	mDNS, DNS-SD	(optional - if desired) Device/Service Discovery
Requests to device from ...					
ANY IP of SSCv2 client	443	HTTPS (TCP)	Unicast	SSCv2 - Spectera Base Station API	Monitor+Control communication from clients
¹ my.nalpeiron.com					

NTP time server pools

- pool.ntp.org
- time.nist.gov
- time.aws.com
- time.cloudflare.com

Ports - Base Station Dante® Network Interfaces

Spectera Base Station requires several ports to be opened for both Dante® Network Interfaces to operate properly. For the list of ports and more detailed information, please refer directly to the Dante® website: [Audinate FAQ - Networks and Switches](#).



SEK

RF transmission power

- up to 50 mW; countrywise limited

RF channels

- 1

Headphone output

- 3.5 mm TRS jack
- 2 × 300 mW RMS (32 Ω, -40 dB THD, 1 kHz)

Microphone / Instrument / Command input

- 3-pin audio socket

Solder side

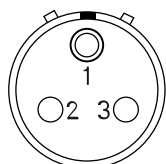

Assignment	Function
Pin 1	Ground & housing
Pin 2	Line In / command*
Pin 3	Mic In & bias voltage
Housing	Ground

*for auto line detection short pin 1 and 3

Power supply

- BA 70 rechargeable battery pack

Battery operating time

- up to 7 h (unidirectional microphone use)
- up to 6 h (unidirectional IEM use)
- up to 5 h (bidirectional use)

Dimensions

- approx. 83 x 62 x 21 mm (3.39" x 2.44" x 0.83") (without antenna)



Weight

- approx. 178 g (0.39 lbs) (with BA 70)
- approx. 144 g (0.32 lbs) (without BA 70)

Temperature

- Operation: -10 °C to +50 °C (14 °F to 122 °F)
- Storage: -25 °C to +70 °C (-13 °F to 158 °F)

Relative air humidity

- 25 % to 95 % (non-condensing)



DAD

RF transmission power

- up to 100 mW; countrywise limited

RF channels

- 1

Base Station connection

- Ruggedized RJ45 including PoE, max. 100 m cable, CAT5e or better, 1 Gbit/s

Power consumption

- PoE class 2 (< 6.5 W)

Apex angle vertical

- vertical
 - UHF: 65 °
 - 1G4: 62 °
- horizontal
 - UHF: 109 °
 - 1G4: 93 °

Front to back ratio

- UHF: 15 dB
- 1G4: 17 dB

Gain

- UHF: 5 dB
- 1G4: 6.5 dB

Threads for tripod mounting

- Yes / Adapter 3/8" to 5/8"

Dimensions

- UHF: 349 x 292 x 39 mm (13.74" x 11.5" x 1.54")
- 1G4: 231 x 205 x 39 mm (9.09" x 8.07" x 1.54")

Weight

- UHF: 676 g (1.49 lbs)
- 1G4: 534 g (1.18 lbs)



Temperature

- Operation: -10 °C to +50 °C (14 °F to 122 °F)
- Storage: -25 °C to +70 °C -13 °F to 158 °F)

Relative air humidity

- 25 % to 95 % (non-condensing)

IP class

- IP54



CHG 70N-C charger

Power supply

- 12 V DC (single unit or cascade of up to 5 units)
- PoE IEEE 802.3af Class 0 (CAT5e or higher), single unit only

Current consumption

max. 3.5 A for a cascade of up to 5 units

Ethernet

- RJ-45 socket, IEEE802.3
- 100Base-TX (half+full duplex)
- 10Base-T (half+full duplex)

Dimensions

Approx. 200 x 104 x 116 mm

Weight

Approx. 640 g, without power supply unit

Charging slots

2

Charging capacity per slot

- BA 70 rechargeable battery **or**
- EW-DX SK with BA 70 **or**
- EW-DX SKM with BA 70**or**
- SPECTERA SEK UHF/1G4

Charging voltage

4.35 V

Charging current

min. 344 mA

max. 860 mA

Full charging time

Max. 3.5 h

Temperature range

- Charging: -10 °C to +50 °C
- Storage: -20 °C to +70 °C



Relative humidity

Max. 95% (non-condensing)



BA 70 rechargeable battery

Rated capacity

1720 mAh

Nominal voltage

3.8 V

Charging voltage

max. 4.35 V

Charging time

Typically 3 h @ room temperature

Dimensions

Approx. 54 x 30 x 15

Weight

Approx. 33 g

Temperature range

- Charging: 0 °C – +55 °C (32 °F – 131 °F)
- Discharging: -10 °C to +55 °C
- Storage: -10 °C to +45 °C

Relative humidity

- Charging/discharging: 25% to 95%, non-condensing
- Storage: 30% to 70%, non-condensing



L 70 USB charger

Charging capacity

2 Sennheiser BA 70 rechargeable battery packs

2x Sennheiser battery BA 62 with 2x L 70 adapter BA 62

Input voltage

Typically 5 V

Input current

max. 2 A

Charging voltage

nominally 4.35 V

Charging current

max. 860 mA per battery pack

Charging time

max. 3.5 h with NT 5-20 UCW power supply unit

Temperature range

- Charging: 0 °C to +55 °C
- Storage: -20 °C to +70 °C

Relative humidity

Max. 95% (non-condensing)

Dimensions

100 × 35 × 70 mm (1 3/4" x 3 7/8" x 7 3/16")

Weight

Approx. 86 g



Modular L 6000 charger

Charging capacity

- Up to 8 rechargeable batteries (BA 60, BA 61, BA 62 and BA 70) across 4 exchangeable charging modules (LM 6060, LM 6061, LM 6062 and LM 6070)

Charging times at 20° C

- BA 60
 - 80%: approx. 1:15 h (approx. 4:45 h operating time)
 - Full: approx. 2:30 h
- BA 61
 - 80%: approx. 1:45 h (approx. 5:00 h operating time)
 - Full: approx. 3:15 h
- BA 62
 - 80%: approx. 1:15 h (approx. 9:30 h operating time)
 - Full: approx. 2:45 h
- BA 70
 - 80%: approx. 1:45 h
 - Full: approx. 3:30 h

Charging temperature range

- 0 to 50 °C (32 °F to 122 °F)

Charging status display

- Multi-colored

Network

- IEEE 802.3-2002 (10/100 Mbit/s), shielded RJ-45 connection

Power supply

- AC 100 – 240 V, 50/60 Hz

Maximum power consumption

- 85 W

Minimum power consumption

- 1 W

Power plug

- 3-pin, protection class I as per IEC/EN 60320-1



Dimensions (H × W × D with mounting elements)

- 44 x 483 x 373 mm

Weight

- 5.1 kg



LM 6060 | LM 6061 | LM 6062 | LM 6070 charging modules

Dimensions (H × W × L)

- 44 x 99 x 182 mm

Weight

- 144 g

Rechargeable battery type

- LM 6060: 2× BA 60
- LM 6061: 2× BA 61
- LM 6062: 2× BA 62
- LM 6070: 2× BA 70

